



Forum of Regulators (FOR)

REPORT OF THE FORUM OF REGULATORS ON “ANALYSIS OF FACTORS IMPACTING RETAIL TARIFF AND MEASURES TO ADDRESS THEM”

**Secretariat: Central Electricity Regulatory Commission
Chanderlok Building, 36 Janpath, New Delhi**

Table of contents

1. Introduction.....	4
2. Analysis.....	6
2.1. Details of Analysis.....	6
2.1.1 Power Purchase Cost.....	6
2.1.2. Transmission Charge.....	7
2.1.3. Fixed Cost related factors	8
3. Recommendations.....	11
3.1. External Factors.....	11
3.1.1. Coal.....	11
3.1.2. Railway freight.....	12
3.1.3. Clean Energy Cess.....	12
3.1.4. New Environmental Norms.....	13
3.1.5. New Norms for disposal and transportation of fly ash	13
3.2. Internal Factors.....	14
3.2.1. High transmission costs	14
3.2.2. Generation assets are also stranded. Old gas plants are too expensive and fixed costs are being paid without any utilization.	14
3.2.3. Return on equity allowed to Generation / Transmission and distribution companies needs to be made more realistic and at par with interest rates.....	15
3.2.4. Impact of depreciation on tariff.....	16
3.2.5. Growing share of Renewable Energy	16
3.2.6. Right Energy mix and right mix of long term, medium term and short term PPAs – Best practices	17
3.2.7. Cost optimisation through greater use of market – Best practices.....	17
3.2.8. Trading Margin be curtailed.....	17
3.2.9. Waiver of water usage charges for Hydro Projects.....	18
3.2.10. Distribution level efficiency in operation.....	18
3.2.11. Other suggestions	18
4. Summary of Recommendations.....	19
4.1. External Factors.....	19

4.1.1.	Coal.....	19
4.1.2.	Railway freight.....	19
4.1.3.	Clean Energy Cess.....	20
4.1.4.	New Environmental Norms.....	20
4.1.5.	New Norms for disposal and transportation of fly ash	20
4.2.	Internal Factors.....	20
4.2.1.	High transmission costs	20
4.2.2.	Generation assets are also stranded. Old gas plants are too expensive now and fixed costs are being paid without any utilization.....	21
4.2.3.	Return on equity allowed to Generation/ Transmission and distribution companies needs to be made more realistic and at par with interest rates.....	21
4.2.4.	Impact of depreciation on tariff.....	22
4.2.5.	Growing Share of Renewable Energy.....	22
4.2.6.	Right Energy mix and right mix of long term, medium term and short term PPAs – Best practices	22
4.2.7.	Cost optimisation through greater use of market – Best practices.....	23
4.2.8.	Trading Margin be curtailed.....	23
4.2.9.	Waiver of water usage charges for Hydro Projects.....	23
4.2.10.	Distribution level efficiency in operation.....	23
4.2.11.	Other suggestions	24

1. Introduction

The Forum of Regulators (FOR), in its Special Meeting held on 16.10.2020 deliberated on various factors leading to high cost of power, several of which are beyond the control of the electricity regulators and felt the need to analyse and evolve measures towards reduction or at least containment of retail tariff. The FOR also decided to form a Working Group (WG) to look into the issues raised during the meeting.

Accordingly, this Working Group was constituted with the following composition:-

- Chairperson, Punjab State Electricity Regulatory Commission – Chairperson
- Chairperson, Gujarat Electricity Regulatory Commission – Member
- Chairperson, West Bengal Regulatory Commission – Member
- Chairperson, Odisha Regulatory Commission – Member
- Chairperson, Tamil Nadu Regulatory Commission – Member
- Chairperson, Joint Electricity Regulatory Commission (Goa &UTs) – Member
- Chief, (Regulatory Affairs), Central Electricity Regulatory Commission-Convener

The broad scope of work of the Working Group included the following:-

- a) Analysis of various components of power purchase cost (PPC) and their impact on retail tariff.
- b) Analysis of external factors (i.e. factors external to electricity sector) and internal factors (across the value chain of generation, transmission and distribution) impacting retail tariff.
- c) To suggest measures for addressing the issues arising out of the analysis from (a) & (b) above.
- d) Any other matter related and incidental to the above.

A copy of the order constituting the Working Group is **enclosed** as **Annexure - I**

The first meeting of the WG was held on 2nd November 2020 (minutes **enclosed** as **Annexure II**). The second meeting was held on 7th December 2020 (minutes **enclosed** as **Annexure III**). The

3rd, 4th and 5th meeting for finalizing the recommendations were held on 11th December 2020, 28th December 2020 and 30th December 2020 respectively through virtual mode.

In the first meeting, the WG decided that the factors impacting retail tariff were to be examined in detail and for this purpose, the possibility of seeking the assistance of consultants who could help in terms of simulation of data be explored. Accordingly, the services of a consortium of consultants- M/s KPMG, M/s ABPS and CER of IIT Kanpur were made available to the WG with the approval of the Chairperson, FOR. This consortium was already assisting FOR under the PSR program under the aegis of an MOU between the Government of India and the Government of UK. The consultants carried out simulation of data for 12 States, namely Andhra Pradesh, Assam, Bihar, Gujarat, Haryana, Jharkhand, Karnataka, Kerala, Madhya Pradesh, Odisha, Uttar Pradesh and Uttarakhand. Cumulatively, these States account for 50% of the total energy consumed in the country.

A detailed presentation was made by the consulting agencies highlighting the respective contribution of various factors in the Average Cost of Service (ACoS) which forms the basis for the determination of retail tariff. The presentation made by the consulting agencies has been provided at **Annexure-IV(a), IV(b), IV (C), IV (d) and IV (e)** to this report. Various data sets as in the presentation were noted by the Working Group and after further discussions on various aspects including the factors highlighted by the consulting agencies, the WG arrived at the findings and recommendations which were presented to the Forum of Regulators for consideration.

The Forum deliberated the report in detail in its 75th Meeting held on 30th April, 2021 and finalized the recommendations as outlined in subsequent sections.

2. Analysis

Based on the details of the analysis of data for 12 States, the WG found that the PPC accounts for about 67% - 78% of the ARR, followed by transmission charges and the O&M expenses. Transmission charges are seen to be contributing in the range of 9.5% - 13.5% and O&M expenses in the range of about 6% - 21%. Accordingly, the WG felt the need to deep dive into the factors of PPC, transmission charges, O&M charges and other factors.

2.1. Details of Analysis

The details of analysis carried out have been provided below:

2.1.1 Power Purchase Cost

Since the PPC is the greatest contributor to the costs in the ARR, further analysis was undertaken in terms of the contribution of the sub components of PPC such as fuel cost, railway freight charges, distribution losses etc., The following insights emerged:-

- In the power purchase cost for sample station, the contribution of coal price has been in the range of 25%, rail freight at 41%, road transportation charges at 11%, clean energy cess at 11% and others at 12%.
- The Impact analysis of clean energy cess was also made. It was found that clean energy cess has increased over time, from Rs 50 per tonne in June, 2010 to Rs 400 per tonne of coal since March 2016. The total impact of coal cess on the power sector is around Rs 25000 Crore per year during last 3 years. Presently, the impact assessment shows that a reduction in clean energy cess of Rs 100 per metric tonne (MT) would lead to a saving of about 6 paisa per unit which would translate into a saving of 3% of the Average Cost of Supply (ACoS). Similarly, a reduction of Rs 50 per MT of clean energy cess would lead to a saving of 3 paisa per unit.
- The next element examined was the impact of GCV loss. The GCV loss has a direct impact on the overall energy charges. The GCV loss due to grade slippage between “as billed” and “as received” has been in the range of approximately 600 kCal/ kg. Analysis

reveals that every 100 Kcal/ kg saving in GCV loss would translate into a saving of energy charges in the range of 3%. Thus, this is an important area which deserves immediate attention and can substantially reduce the retail tariff for electricity consumers.

- On the coal price front, it was revealed that the prices of G11 to G14 grade of coal (used for generation in power plants) have increased since FY 2016, the increase being in the range of 13% - 18%. It was also revealed that this increase in price was 28% higher in comparison to the estimated price increase based on the weighted average of WPI and CPI.
- The analysis of the railway freight charges revealed that for coal and coke, freight charges have increased twice during the calendar year 2018, the increase being 21% in January 2018 and 9% in November 2018. The increase in railway freight charges in November 2018 was 30% higher as compared to the estimated increase computed based on weighted average of WPI and CPI.
- Thus, both Coal and Railway freight issues are external factors which need to be regulated.

2.1.2. Transmission Charge

Another important element in the power purchase cost is the transmission charge. The data analysis revealed that a huge investment has been made in the inter-state transmission sector in the past 10 years.

The annual transmission charges for inter-state transmission have increased from Rs 9,000 crore in FY 2011-12 to more than Rs 39,000 crore in the FY 2019-20 translating into a CAGR 21% during this period. Per unit charges for energy transmitted through interstate transmission system have increased at a CAGR of 15% over the same period.

A comparison of CTU and STU charges, between FY 2016-17 to FY 2019-20, for the 12 study states, was also undertaken. The CAGR of CTU charges and the STU charges during this period, for the study States, were found to be as under:

S No	State	CTU charges (CAGR)	STU charges (CAGR)
1	Odisha	23%	4%
2	Uttarakhand	10%	-1%
3	Madhya Pradesh	1%	7%
4	Karnataka	24%	4%
5	Kerala	4%	-3%

S No	State	CTU charges (CAGR)	STU charges (CAGR)
6	Jharkhand	9%	32%
7	Assam	0%	7%
8	Uttar Pradesh	25%	3%
9	Gujarat	11%	10%
10	Haryana	40%	3%
11	Bihar	6%	63%
12	Andhra Pradesh	59%	18%

The analysis shows that the inter-State transmission system was designed for projected peak demand of 2,01,000 MW for FY 2019-20 whereas the actual peak demand for the same year turned out to be 1,84,000 MW. Actual energy requirement in FY 2019-20 was 1,290 BU as against the projection of 1,400 BU. Similar trends are seen in previous years as well. Demand not increasing as per projections is one of the reasons for higher per unit transmission charge.

Another important finding that emerged is that competition in the transmission service procurement has led to substantial decrease in overall costs. Recent trends of competitive bidding in transmission reveal that the levelised tariffs for competitively bid projects have been lower than those on cost plus basis.

It was also noted that green corridor related energy transmission costs are being loaded on to the CTU cost.

The group also felt that the central transmission utility works are taken up without the SERCs being apprised of the plan at any stage, This needs to be remedied.

2.1.3. Fixed Cost related factors

The impact of other factors on the retail tariff including the fixed cost elements (RoE, O&M and depreciation cost) was then taken up.

A comparison of the RoE allowed by different States for generation, transmission and distribution revealed that the post-tax RoE has been in the range of 14% - 16%. An analysis was also made regarding the prevailing cost of debt and it was found that the lending rate has been on the lower side for quite some time. While the RoE has an element of risk premium, the data analysis

revealed the need for reconsidering the RoE keeping in view the prevailing prime lending rate and 10 - year G-Sec rate. The contribution of RoE on generation, transmission and distribution, in respect of 12 States were studied. It transpired that if the RoE was reduced from 15.5% to 14%, there would be reduction of 2 paisa per unit of retail tariff and if it was reduced further to the level of 12%, it will lead to a reduction of 7 paisa per unit of retail tariff.

The next issue which was examined in detail was depreciation cost. Regulatory practices in other sectors on this front were also analysed. The impact/contribution of depreciation on overall ARR was presented. It emerged that if the loan repayment period considered for depreciation is extended from 12 years to 15 years, it would decrease the ACoS by 8 paisa per unit of retail tariff. Further, if the depreciation rate is reduced to 4.3%, considering the loan period of 15 years to repay 65% of the capital cost, the reduction in retail tariff could be in the range of 10 paisa.

Analysis of internal factors was also undertaken. It revealed that substantial savings can be made if distribution losses are reduced. The impact of O&M charges and interest and finance charges were also analysed. It revealed that the approved O&M expenses for the FY 2020-21 in the 12 study States ranged between 6% -21%. For example, in Assam the O&M charge was in the range of Re 1 per unit of energy handled by the Discom. The O&M charges of the generator of the study States varied in the range of 10% -16%. The interest and financing charges for the study States varied in the range of approximately 1% - 9%. For example, in Kerala, the interest and financing charges were about 50 paisa per unit of energy handled. There is a significant scope of reducing AT&C losses by better reactive power management as has been adopted in Tamil Nadu. Details have been provided in **Annexure-V**.

Apart from the above factors, other external factors, especially the impact of under-utilisation of assets and the impact of compliance of environmental norms were also undertaken. It was revealed that retiring inefficient old plants which have been in use for more than 30 years would reduce the energy charges by 4% - 23%. For the Flue Gas Desulfurisation (FGD) components, estimate was made based on the benchmark capital cost provided by CEA and operational and financial norms provided by CERC. The total impact of FGD was computed to be in the range of about 24 paisa per unit of the energy.

The Ministry of Environment, Forest and Climate Change vide its Draft Notification dated 22nd April 2021 seeks to make the Thermal Power Plants (TPPs) responsible for 100% utilisation of

ash (fly ash and bottom ash) generated by it for eco-friendly purposes like manufacturing of brick /blocks/tiles, cement manufacturing, road construction etc. As per the draft notification every coal or lignite based TPPs shall ensure that loading, unloading, transport, storage and disposal of ash is done in an environmentally sound manner and that all precautions to prevent air and water pollution are taken.

The Draft Notification also stipulates that all agencies (Government, Semi Government and Private) engaged in construction activities such as road laying, road and flyover embankments, shoreline protection structures in coastal districts and dams within 300 km from the lignite/coal based TPPs shall mandatorily utilise ash in these activities, provided it is delivered at the project site free of cost and transportation cost is borne by such coal/lignite based thermal power plants.

Hence, as per the Draft notification, the cost of transportation of fly ash is to be borne by TPPs, which will have substantial impact on cost of generation on thermal power plants. Assuming an average generation of 250 gm/kwh and ash transportation cost of Rs 2-3/MT/300km, the total impact on cost of generation works out to be around 15-23 paise/unit for 300 km of ash transportation.

3. Recommendations

The WG, based on the details of the analysis for 12 States, observed that PPC is the largest contributor to the average cost of supply, having on an average more than 70% share in the cost for a distribution company. Following PPC, transmission charges and O&M Expenses have a major share. The WG delved deep into these factors and found that several of them are external to the electricity sector and need intervention of the Central Government/agencies. There are internal factors, equally important, deserving attention. Accordingly, the WG has made recommendations under these two broad heads, viz., external and internal, thereby highlighting the need for a coordinated effort by the Centre and the States to address the issue of high retail tariff.

3.1. External Factors

3.1.1. Coal

Coal cost is a major contributor in PPC. The increase in coal price was 28% higher in comparison to the estimated price increase based on the weighted average of WPI and CPI. It has also been observed that a number of inefficiencies of the coal sector are being passed on to the power sector. There is significant grade slippage (exceeding 600 Kcal/kg in many cases), the cost of which is borne by electricity consumers. As evident from the analysis, every 100 Kcal/ kg saving in GCV loss would translate into energy charges saving of approximately 5 paise per unit. Hence, it is recommended that the coal sector be brought under an independent regulator at the earliest. Regulation of coal sector is required to stem inefficiency and improve performance so that consumers (of coal) including the power sector, benefit.

Coupled with this, is the need for the electricity regulators to monitor and suitably regulate Station Heat Rate (SHR) and GCV of coal based power plants. These two factors, if regulated properly, can reduce energy charge significantly. GCV should not be allowed on “as fired” basis as is still being done by several States. Rather, it should be based on “as received” basis or “as billed” plus margin of errors (due to transportation and other losses) as payment is made to the coal companies on the basis of billed GCV. Third party assessment/measurement of GCV is important. There is an

urgent need for evolving a proper sampling and measurement mechanism to control the grade slippage and GCV losses. CERC should empanel a list of independent technically qualified agencies/labs for this purpose.

As per the fuel supply agreement (FSA) between the coal supplier and the generators, the coal supplier does not provide any compensation for surface moisture of coal upto 7% in dry season and 9% in wet season. Full compensation should be provided for the surface moisture as it has no heat value

Thus, Ministry of Power and Ministry of Coal need to find out a solution to the issue of grade slippage and losses due to moisture content. Coal pricing needs to be regulated as in other sectors, since it is virtually a monopoly.

3.1.2. Railway freight

Another considerably significant portion of the PPC is contributed by railway freight. There has been an increase of 40% in the railway freight charges in the past 4 years. The increase in freight charges has been unbridled and significantly higher than what WPI/CPI could justify. It is suggested that the RoE for railways be regulated. Railways should also be brought under an independent regulatory body as they enjoy monopoly position. The Central Government may also consider subsidizing railway freight for a distance beyond 750 kms.

3.1.3. Clean Energy Cess

Clean energy cess has increased from Rs. 50/- per ton in June 2010 to Rs. 400/- per ton at present, thereby impacting retail tariff.

The total impact of Clean Energy cess since FY 2010-11 based on the coal consumption each year for the power sector is shown in the table below:

S. No.	Year	Coal Consumption for the Power Sector (Million metric tonne)	Clean Energy Cess (Rs Crore)
1	2010-11	396	990
2	2011-12	438	2,188
3	2012-13	485	2,427

S. No.	Year	Coal Consumption for the Power Sector (Million metric tonne)	Clean Energy Cess (Rs Crore)
4	2013-14	493	2,466
5	2014-15	498	3,733
6	2015-16	518	9,492
7	2016-17	535	19,618
8	2017-18	608	24,320
9	2018-19	629	25,144
10	2019-20	622	24,883

Source(Coal Consumption): MOSPI(Energy Statistics,2019)

With the increasing investment in renewables, the rationale for continuation of this cess needs review. If it is to be continued then it is recommended that the proceeds from this cess be ploughed back to the electricity sector to mitigate the incremental cost on account of new environmental norms as per contribution made by each State.

3.1.4. New Environmental Norms

With the implementation of new environmental norms, the cost per unit of energy is going to increase substantially. This increase in cost should be compensated from the clean energy cess which has been collected from the consumers of the electricity sector. This cess should be used to reduce retail tariff impact as a result of FGD installation in the thermal plants.

3.1.5. New Norms for disposal and transportation of fly ash

As per the draft notification dated 22nd April, 2021, issued by the Ministry of Environment, Forest and Climate Change, the cost of transportation of fly ash is to be borne by the thermal power plants (TPPs), which will have substantial impact on cost of generation on thermal power plants. Assuming an average generation of 250 gm/kwh and ash transportation cost of Rs 2-3/MT/300km, the total impact on cost of generation works out to be around 15-23 paise/ unit for 300 km of ash transportation. As this will have substantial impact on cost of generation and hence on consumer tariff, it is recommended that the cost of transportation of fly ash be partially borne by the Central/ State Government.

3.2. Internal Factors

3.2.1. High transmission costs

There has been huge investment in inter-state transmission but utilization of the assets has not been commensurate with the investment. Reliability of supply and market access have definitely increased due to construction of transmission systems but the disconnect in planning is obvious. Owing to the under-utilisation of transmission assets, a high cost is being paid by the consumers. The retail electricity consumers should not be burdened with the monetary implications arising due to forecasts of transmission planners, especially when the forecasts have not been fully achieved resulting in low or partial use of the system. It is recommended that in future, transmission planning should be based on accurate demand forecasts by discoms and STUs.

The Central Government should share the cost of the stranded assets, by utilising the clean energy cess. As the cess is being collected from power sector, it should be used to provide relief to the sector.

As per the Tariff Policy, tariff of all new transmission projects, including state owned projects, should be determined on the basis of a competitive bidding process for projects, costing above a threshold limit which shall be decided by the SERCs. Some SERCs (like Punjab and Bihar) have defined threshold limit for this purpose. It is recommended that all SERCs should decide a normative threshold above which projects be selected through tariff based competitive bidding.

It is also suggested that FOR may also have a special meeting on this issue to work out a solution.

3.2.2. Generation assets are also stranded. Old gas plants are too expensive and fixed costs are being paid without any utilization.

As in the case of transmission assets, the fixed cost of stranded generation assets is being paid for by the consumers without getting any benefit. The stranded costs (in respect of 12 States studied), due to under-utilisation of generation assets have been provided at the table below

S No.	State	Year	Surplus Energy (MU)	Fixed Cost for Surplus Energy (Rs Crore)
1	Odisha	FY 2020-21	5,941	348
2	Uttarakhand	FY 2020-21	(536)	NIL

S No.	State	Year	Surplus Energy (MU)	Fixed Cost for Surplus Energy (Rs Crore)
3	Madhya Pradesh	FY 2019-20	28,636	4,325
4	Kerala	FY 2020-21	782	121
5	Jharkhand	FY 2020-21	5,707	563
6	Assam	FY 2018-19	864	294
7	Uttar Pradesh	FY 2020-21	22,416	4,394
8	Gujarat	FY 2020-21	11,220	1,528
9	Haryana	FY 2020-21	14,870	1,719
10	Bihar	FY 2020-21	14,301	1,294
11	Andhra Pradesh	FY 2020-21	9,504	917
12	Punjab	FY 2019-20	15546.18	1879.45
	Total		129251.18	17442.45

Surplus energy of this magnitude and resultant costs (in the range of Rs. 1.34 per unit) are a matter of great concern. Further, the cost of balancing renewables has been estimated to be in the range of Rs.1.10/unit by CEA. In addition, the additional stranded capacity cost (incremental fixed charge) estimated on account of RE integration is in the range of Rs.1.02/ unit (Reference Minutes of FOR meeting held on 20th September, 2019 at Amritsar). Government should extend help to the discoms to meet the fixed cost of the PPAs associated with the stranded assets. The burden of the stranded generation assets should be shared by the Central Government and the State Government respectively in the ratio of 60:40, in line with central plan funding. Further, the stranded asset costs should also cover the impact in respect of plants that are under annual maintenance and R&M.

3.2.3. Return on equity allowed to Generation / Transmission and distribution companies needs to be made more realistic and at par with interest rates.

In the entire value chain, transmission business has the lowest risk. The RoE for transmission companies should therefore, be reviewed immediately. RoE for generation and transmission should be linked to the 10 year G Sec rate (average rate for last 5 years) plus risk premium subject

to a cap as may be decided by Appropriate Commission. For a discom, the RoE could be fixed based on the risk premium assessed by the State Commission . Income tax reimbursement should be limited to the RoE component only.

Performance of Distribution licensees has a significant impact on retail tariff for the consumers. Therefore there is a need to link recovery of RoE with the performance of the utilities, based on indicators such as supply availability, network availability, AT&C loss reduction.

3.2.4. Impact of depreciation on tariff

Depreciation rate should be rationalized and the period of depreciation should be extended. Depreciation period could be extended to 15 years from 12 years and the rate could be 4.3% based on straight line method for the first 15 years and the remaining depreciation to be recovered during the balance useful life. Accumulated depreciation, over and above debt repayment, should be used to reduce the equity base for RoE.

3.2.5. Growing share of Renewable Energy

Although green power is available at ₹ 2.5/unit or less now, the costs of transmission and balancing cost are eating into the benefits it could have brought. Initially, the renewable power policy laid emphasis on distributed generation which could have avoided transmission asset creation. However, the current focus seems to have shifted to large scale renewable projects. In the large RE segment, hybrid renewable (combination of wind and solar), round the clock (RTC) schedulable power and renewable with energy storage should be encouraged, which could lead to better utilization of transmission assets. Apart from large scale renewable projects, focus in future should also be on distributed generation that would minimize transmission infrastructure and would help reduce the cost.

3.2.6. Right Energy mix and right mix of long term, medium term and short term PPAs – Best practices

DISCOMs willing to exit from PPAs of old plants that have outlived their life or are very costly should not be tied to BPSA. Furthermore, 25 years life of PPAs for new projects contracted through competitive bidding is too long and shorter duration PPAs with exit clause should be promoted. It should also be ensured that the exit clause is not very stringent.

3.2.7. Cost optimisation through greater use of market – Best practices

There is a lot of scope for reduction of power purchase cost if Merit order dispatch (MoD) is followed strictly and power market and other platforms are used for optimisation of power procurement. This exercise needs to be followed by all States by making a comparison of their own generation variable cost with the likely power exchange price and procuring power from the exchange if the latter is lower. Some of the best practices in this context have been provided at **Annexure-VI**. Also, the Security Constrained Economic Despatch (SCED) framework which has yielded substantial savings at the national level, should be adopted in States, provided it brings benefit to the consumers in terms of overall tariff.

SLDCs should be given independent status and it should be their responsibility to ensure merit order dispatch of electricity on day ahead and real time basis. Merit order must be prepared by SLDC every month based on the actual fuel prices of the last month.

3.2.8. Trading Margin be curtailed

Trading margin, as stipulated by CERC, can be made more equitable. Although the current average trading margin lies within approximately 3-4 paise/unit, the ceiling of 7 paise/unit provided by CERC, along with the “as per mutually negotiated” clause is being misused by public sector traders. CERC should look into the matter and cap the same at 2 paise/unit. Similar cap can be specified by SERCs and discoms should be directed to adhere to this cap while giving consent to bids for procurement through any trader.

3.2.9. Waiver of water usage charges for Hydro Projects

The matter of waiver of water usage charges for hydro projects may be taken up by the FOR and MoP.

3.2.10. Distribution level efficiency in operation

There is a significant scope of reducing AT&C losses by better reactive power management as has been adopted in Tamil Nadu. Further, the SERCs should provide for long term trajectory for loss reduction and ensure that the trajectory is adhered to by the Discoms strictly. AT&C loss reduction has the potential of reducing the retail tariff significantly.

A common regulation also needs to be brought in to curtail the losses of DISCOMs. Losses above the prescribed should not be allowed and the gains accruing from over achievement of loss reduction targets should be shared with the consumers. In Odisha, for instance a 10-year loss reduction trajectory has been fixed by the regulator as part of the privatisation strategy.

3.2.11. Other suggestions

All future generation projects, except hydro power projects and nuclear power projects should be set up only through competitive bidding.

The norms for O&M Expenses should be made more stringent by CERC. The norms of interest on working capital should also be reviewed by CERC keeping in view the current realities of decreasing level of PLF resulting in reduced fuel stock requirement, etc.

4. Summary of Recommendations

The recommendations, as suggested by the WG, to address the issues related to retail tariff of electricity have been summarised below:

4.1. External Factors

4.1.1. Coal

- Coal sector be brought under an independent regulator at the earliest.
- Electricity regulators should monitor and suitably regulate SHR and GCV of coal based power plants.
- GCV should not be allowed on “as fired” basis. Rather, it should be based on “as received” basis or “as billed” plus margin of errors (due to transportation and other losses). Third party assessment/measurement of GCV is important. CERC should empanel a list of independent technically qualified agencies/ labs for this purpose.
- There is an urgent need for evolving a proper sampling and measurement mechanism to control the grade slippage and GCV losses.
- Full compensation should be provided by the coal company for surface moisture in coal as it has no heat value. Ministry of Power and Ministry of Coal need to find out a solution to the issue of grade slippage and losses due to moisture content.

4.1.2. Railway freight

- Railways should be brought under an independent regulatory body as they enjoy monopoly position and are still unregulated at present.
- RoE for railways should be regulated.
- Central Government may consider subsidizing railway freight for coal for a distance beyond 750 kms

4.1.3. Clean Energy Cess

- With due regard to the increasing investment in renewable, the rationale for continuation of this cess needs review. There is a strong case for reduction in clean energy cess.
- Proceeds from this cess be ploughed back to the electricity sector to mitigate incremental cost on account of new environmental norms as per contribution made by each State.

4.1.4. New Environmental Norms

- With the implementation of new environmental norms, the cost per unit of energy is certainly going to increase. This increase in cost should be compensated from the clean energy cess.
- The energy cess should be used to reduce retail tariff impact as a result of FGD installation in the thermal plants.

4.1.5. New Norms for disposal and transportation of fly ash

- Proposed norms for disposal and transportation of fly ash will have substantial impact on cost of generation and hence on consumers tariff. It is recommended that the cost of transportation of fly ash be partially borne by the Central/ State Government.

4.2. Internal Factors

4.2.1. High transmission costs

- It is recommended that in future, transmission planning should be based on accurate demand forecasts by discoms and STUs.
- The retail electricity consumers should be compensated for the monetary implications arising due to under-utilisation of transmission assets.
- The Central Government should share the cost of the stranded transmission assets by utilising the clean energy cess.

- Tariff policy provides that tariff of all new transmission projects including state owned projects, costing above a normative threshold limit which shall be decided by the ERCs, should be determined on the basis of a competitive bidding process. All SERCs should decide threshold limit (say, 100 Crore or so) above which projects be selected through tariff based competitive bidding.

4.2.2. Generation assets are also stranded. Old gas plants are too expensive now and fixed costs are being paid without any utilization.

- Government should extend help to discoms to meet the fixed cost of the PPAs associated with the stranded assets.
- The burden of the stranded generation assets should be shared by the Central Government and the State Government respectively in the ratio of 60:40, in line with central plan funding.
- Further, the stranded asset costs should also cover the impact in respect of plants that are under annual maintenance and R&M.

4.2.3. Return on equity allowed to Generation/ Transmission and distribution companies needs to be made more realistic and at par with interest rates.

- RoE for generation and transmission should be linked to the 10 year G Sec rate (average rate for the previous 5 years) plus risk premium subject to a cap as may be decided by appropriate Commission.
- For a discom, the RoE could be fixed based on the risk premium assessed by the State Commission. Income tax reimbursement should be limited to the RoE component only.
- Performance of Distribution licensees has a significant impact on retail tariff for the consumers. Therefore, there is a need to link recovery of RoE with the performance of the utilities, based on the indicators such as supply availability, network availability, AT&C loss reduction .

4.2.4. Impact of depreciation on tariff

- Depreciation rate should be rationalized and the period of initial higher depreciation rate be extended to 15 years from 12 years.
- The rate of depreciation should be 4.3% for the first 15 years based on straight line method, instead of around 5.28% for the first 12 years and the remaining depreciation should be recovered during the balance useful life.
- Accumulated depreciation, over and above debt repayment, should be used to reduce the equity base for RoE after debt repayment is over.

4.2.5. Growing Share of Renewable Energy

- In the large RE segment, hybrid renewable (combination of wind and solar) and renewable with energy storage should be encouraged, which could lead to better utilization of transmission assets.
- Apart from large scale renewable projects, the focus, in future, should be on distributed generation (preferably in agriculture segment) that would minimize the requirement for transmission infrastructure and would help reduce the cost.
- The expenditure to meet statutory requirements (for instance, costs towards meeting environmental norms) should not be passed on completely to the consumers. Instead, the clean energy cess should be utilized to meet these requirements.

4.2.6. Right Energy mix and right mix of long term, medium term and short term PPAs – Best practices

- DISCOMs willing to exit from PPAs of old plants, that have outlived their life or are very costly, should not be tied to BPSA.
- 25 years life of PPAs for new projects contracted through competitive bidding is too long and shorter duration PPAs with exit clause should be promoted. It should also be ensured that the exit clause is not very stringent.

4.2.7. Cost optimisation through greater use of market – Best practices

- There is a lot of scope for reduction of power purchase cost if Merit order dispatch (MoD) is followed strictly and power market and other platforms are used for optimisation of power procurement. This exercise needs to be followed by all the States.
- The Security Constrained Economic Despatch (SCED) framework should be adopted in States for cost optimization, provided it brings benefit to the consumers in terms of overall tariff.
- SLDCs should be given independent status. It should be their responsibility to ensure merit order dispatch of electricity on day ahead and real time basis. Merit order must be prepared by SLDC every month based on the actual fuel prices of last month.

4.2.8. Trading Margin be curtailed

- Trading margin, as stipulated by CERC, can be made more equitable. It should be capped at 2 paise per unit.
- Similar cap can be specified by SERCs and discoms should be directed to adhere to this cap while giving consent to bids for procurement through any trader.

4.2.9. Waiver of water usage charges for Hydro Projects

- The matter of waiver of water usage charges may be taken up by the FOR and MoP with the respective State Governments.

4.2.10. Distribution level efficiency in operation

- There is a significant scope of reducing AT&C losses by better reactive power management as has been adopted in Tamil Nadu.
- SERCs should specify long term trajectory for loss reduction and ensure that the trajectory is adhered to by the Discoms strictly.

- A common regulation needs to be brought in to curtail the losses of DISCOMs. Losses above a pre-specified limit should not be allowed, and the gains accruing from over achievement of loss reduction targets should be shared with the consumers.

4.2.11. Other suggestions

- All future generation projects, except hydro power projects and nuclear power projects should be procured through competitive bidding.
 - The norms for O&M Expenses should be made more stringent by CERC.
 - The norms of interest on working capital should also be reviewed by CERC keeping in view the current realities of decreasing level of PLF resulting in reduced fuel stock requirement, etc.
-

FORUM OF REGULATORS (FOR)

C/o. CENTRAL ELECTRICITY REGULATORY COMMISSION (CERC)

3rd & 4th Floor, Chandralok Building, 36, Janpath, New Delhi 110 001

☎: 011-23353503/23752958

Ref : RA-11018(11)/2/2020-CERC

Date : 27th October 2020

Subject: Constitution of FOR Working Group on “Analysis of factors impacting Retail Tariff and Measures to address them”.

The Forum of Regulators, in its Special Meeting held on 16.10.2020 deliberated on various factors leading to high cost of power, several of which are beyond the control of the electricity regulators and felt the need to analyse and evolve measures towards reduction or at least containment of retail tariff. The Forum also decided to form a working group to look into the issues raised during the meeting (relevant extracts from the minutes of meeting enclosed for reference).

2. Accordingly, the Working Group has been constituted by the competent authority with the following the composition:-

Chairperson, Punjab State Electricity Regulatory Commission	– Chairperson
Chairperson, Gujarat Electricity Regulatory Commission	– Member
Chairperson, West Bengal Regulatory Commission	– Member
Chairperson, Odisha Regulatory Commission	– Member
Chairperson, Tamil Nadu Regulatory Commission	– Member
Chairperson, Joint Electricity Regulatory Commission (Goa &UTs)	– Member
Chief, (Regulatory Affairs), Central Electricity Regulatory Commission	– Convenor

The Secretariat of the Forum of Regulators would provide secretariat services to this Working Group.

3. The Terms of Reference of the Working Group are as under: -

- a. Analysis of various components of power purchase cost and their impact on retail tariff.
- b. Analysis of external factors (external to electricity sector) and internal factors (across the value chain of generation, transmission and distribution) impacting retail tariff.
- c. Suggest measures for addressing the issues arising out of the analysis from (a) & (b) above.
- d. Any other matter related and incidental to the above.

Cont.....

4. The Working Group may co-opt Chairperson/ Member of any other SERC and/or any other expert(s) as deemed fit. The Working Group may also avail the services of a consultant/ consulting-firm/ research organisation in the process of examining the issues related to the subject matter.

5. The Working Group may submit the report within one month, for consideration of the Forum.

Encl: a/a

Sd/-
(Sanoj Kumar Jha)
Secretary

Copy to:

Members of the Working Group

Copy for information to:

- a. Sr Executive to Chairperson, CERC / FOR
- b. Sr. PPS to Secretary, CERC
- c. PS to Chief (RA), CERC

AGENDA ITEM NO.2: PROPOSAL TO FORM A SUB-GROUP IN THE FOR TO SUGGEST MEASURES FOR REDUCING RETAIL TARIFF

A reference was received from Chairperson, WBERC to discuss the issues relating to factors impacting the retail electricity tariffs and with a request to form a sub-group in FOR to analyse the same and make suitable recommendations. The said reference highlighted various factors leading to high cost of power, several of which are beyond the control of the electricity regulators. There is, therefore, a need to analyse and evolve measures towards reduction or at least containment of retail

tariff. WBERC Chairperson added that the Hon'ble Minister of Power, during his interaction with a group of select State electricity regulators a few days back, had touched upon the issues concerning the retail tariff and regulatory process related thereto. And hence, he deemed it fit to bring the same to the knowledge of the FOR, so that FOR can take a view on the matter.

The following transpired during discussion on the reference from WBERC.

- Power purchase cost constitutes 70% of the retail tariff, and in turn is dependent on cost of coal, taxation and railway freight. Quality of coal, grade slippages, increasing railway freight are major concerns, more so in view of monopoly position of the concerned entities and absence of independent regulators for these sectors, namely coal and railways. The cost of inefficiencies of these sectors gets passed on to the Discoms and ultimately is borne by the electricity consumers. These cost of inefficiencies is beyond the regulatory jurisdiction of the electricity regulators.

- The current fuel supply agreements and rail transport agreements are totally one sided. There is a need to rewrite these contracts on commercial principles. The Ministry of Power is required to take this issue up with Ministry of Coal and Ministry of Railways.

- Factors like high transmission charges, higher ROE, front loaded depreciation are also contributing to increase in retail tariffs for consumers, which need to be relooked.

- Stranded assets and lower PLF, especially as a result of increasing renewable, are resulting in fixed cost liability for the distribution companies.

- There is a need to address the governance structure of the distribution utilities.

- Compliance of new environmental norms will cause severe strain on the finances of the Discoms. Ministry of Power may consider subsidising the FGD projects from the clean energy cess.

- There is a need to evolve a framework for retiring old plants.

- Discoms need to work out the right energy mix, right approach for power procurement on long term basis and cost optimisation through greater use of market.

Chairperson , FOR/ CERC suggested that considering the various issues raised by Forum Members, a Working Group may be constituted to look into all such issues. After discussion, it was decided to form the Working Group with Chairperson of PSERC as Chair and Chairpersons of ERCs of West Bengal, Odisha, Gujarat, Tamil Nadu and JERC (Goa & UTs) as members. The Group may be assisted by FOR Secretariat and other experts as may be co-opted by the Group.

CONCLUSION:

At the end of the meeting, Secretary, FOR/CERC thanked everyone for participation and the officials and staff of the FOR Secretariat for their efforts in organizing the virtual meeting.

The meeting ended with a vote of thanks to the Chair.

MINUTES OF THE 1st MEETING OF THE
FOR WORKING GROUP ON “ANALYSIS OF FACTORS IMPACTING RETAIL
TARIFF AND MEASURES TO ADDRESS THEM”
(Through Video Conferencing)

Day / Date : Monday, 2nd November, 2020
List of Participants : At Appendix -I (Enclosed)

Chairperson, Punjab Electricity Regulatory Commission (PSERC) and the Chairperson of the Working Group welcomed members to the first meeting which was being held on virtual mode. She proposed that Smt Anjali Chandra, Member PSERC who has the background of having worked in CEA may be co-opted as member of the Working Group. This was endorsed by the members of the Group.

Chief (RA), CERC and convenor of the Working Group, apprised the members about the mandate of the Working Group, which included analysing various components of power purchase cost and their impact on retail tariff; analysis of external factors (external to electricity sector) and internal factors (across the value chain of generation, transmission and distribution) impacting retail tariff and suggest measures for addressing the issues arising out such analysis. He also informed the members about the ongoing studies on related subject being conducted by consultants for the Forum of Regulators under the PSR program between Government of India and Government of UK. He further added that as the mandate of the Working Group involved detailed data analysis and simulations, there might be a need for seeking assistance from some agencies/consultants. He added that currently, M/s KPMG, M/s ABPS and CER IITK are offering their support under the PSR program (being funded by DFID).

A presentation on ” Study on Analysis of Historical Trend of Electricity Tariffs for Uttarakhand and Madhya Pradesh” (*Annexure-I*) was arranged in this context. Representatives of M/s ABPS made the presentation and briefed the Working Group about change in average cost of supply (ACoS) over the years and various internal and external factors contributing to change in ACoS.

Chairperson, GERC observed that primarily, external factors contribute to change in ACoS and about 70%- 80% of variation / increase in cost is due to price of coal, freight and cess. Chairperson, OERC raised the issues relating to GCV and moisture content in coal and their impact on electricity consumers. Chairperson, TNERC stated that there is huge grade slippage in coal supply and that the actual GCV is not as per the invoice and this issue needs to be addressed.

Member, PSERC stated that State-wise comparison of O&M Charges and PGCIL Charges should be made. Chairperson, OERC raised the issue of high transmission charges and emphasized the need for regulatory consent from the concerned Commission before creation of inter-State transmission assets. Chairperson, PSERC stated that trading margin of 7 paise per unit charged by CPSUs such as NTPC and SECI is not justified and proposed to address the same in the recommendation of the Working Group. Chairperson, GERC suggested that overall incentives for generation, transmission and distribution need be re-looked. Chairperson, PSERC brought to the notice of the Working Group that all hydro power plants are currently giving 12% - 13% free power to the home State. Similarly, J&K has also been levying water charges since 1971. She requested the Working Group to examine these issues.

Chairperson, OERC stated that technical loss is a major factor and suggested that there should be a study to find out various methods to reduce technical losses. Chairperson TNERC referred to his suggestions about capacitor bank as a low cost solution to reduce losses and requested that this aspect must be included in the recommendations of the Group. He had shared a presentation in this regard (*Annexure-II*). Chairperson, JERC (Goa& UTs) suggested that the Working Group may also identify the external and internal factors for data analysis and recommend methods for cost reduction.

Decision:

Based on the discussion, the following were agreed:

- Smt Anjuli Chandra, Member PSERC who has the background of having worked in CEA be co-opted as member of the Working Group.

- The following issues were identified for detailed examination:
 - A. Since power purchase costs accounts for between 70-80% of the ARR/retail tariff, the factors affecting this segment needs to be looked at
 - a) Coal
 - Its cost is unregulated being a monopoly item
 - Its quality is not the best and grade slippages are not accounted for properly inspite of third party interventions
 - Linkages are not the most economically rationalised
 - Costs are increased and add ons (evacuation charges etc) are one sided
 - b) Railway freight
 - Not regulated and a monopoly
 - Transit losses are one sided determination
 - c) Taxes
 - d) Details of current fuel supply agreements and railway transport agreements need to be looked at
 - e) High transmission costs
 - POC
 - Stranded transmission assets
 - Reg Committees have encouraged expansion of transmission assets without the knowledge or approval of SERCs
 - f) Generation assets also stranded. Old gas plants are too expensive now and fixed costs are being paid without any requirement
 - g) Return on equity allowed to Generation / Transmission and distribution companies needs to be made more realistic and at par with interest rates. Statewise RoE to be studied and a reasonable rate be suggested
 - h) Impact of depreciation on tariff
 - i) Underutilisation of assets
 - Reasons (different in different States)
 - Lower PLF
 - Non-availability of fuel (gas)
 - Quantification and suggestions for future
 - j) Growing share of Renewable energy
 - Stranding of assets
 - More expensive
 - Effect on Discom's liabilities
 - Quantification
 - k) Incentives both for generation and transmission needs to be looked at. In a surplus situation, these are not required
 - l) Right Energy mix and right mix of long term, medium term and short term PPAs – Best practices
 - m) Cost optimisation through greater use of market – Best practices
 - n) New environmental norms
 - Impact on tariff
 - Recommendations in CES Study
 - o) Trading margins be curtailed

p) Free power to Hydro States and water charges

B. Internal factors

- AT&C losses
- Reactive power management

- The services of the consultants assisting CERC/FOR under the PSR program be solicited to conduct a sensitivity analysis of each of the factors identified and for data analysis and simulation of the same after due approval of Chairperson, FOR/CERC.
- Chairperson, PSERC also suggested that the timeline for submission of report by the Working Group be extended considering the necessity of collection of data and its analysis and simulations. This was unanimously endorsed and FOR Secretariat was advised to take suitable action in this regard with the approval of Chairperson FOR.

The meeting concluded with vote of thanks to the Chair.

LIST OF PARTICIPANTS WHO ATTENDED THE 1ST MEETING

OF

**FOR WORKING GROUP ON “ANALYSIS OF FACTORS IMPACTING RETAIL
TARIFF AND MEASURES TO ADDRESS THEM”**

HELD ON MONDAY, THE 2ND NOVEMBER, 2020.

S. No.	NAME	ERC
01.	Ms. Kusumjit Sidhu Chairperson	PSERC
02.	Shri Anand Kumar Chairperson	GERC
03.	Shri M.K. Goel Chairperson	JERC (State of Goa & UTs)
04.	Shri U.N. Behera Chairperson	OERC
05.	Shri M. Chandrasekar Chairperson	TNERC
06.	Shri Sutirtha Bhattacharya Chairperson	WBERC
07.	Ms. Anjali Chandra Member	PSERC
08.	Dr. Sushanta K. Chatterjee Chief (RA)	CERC
09.	Ms. Rashmi Somasekharan Nair Dy. Chief (RA)	CERC
10.	Shri Arun Kumar Assistant Secretary	FOR
11.	Shri Manvendra Pratap Research Officer	CERC
SPECIAL INVITEES		
12.	Shri Suresh Gehani, Director	ABPS Infrastructure Advisory Private Limited
13	Shri Nitesh Tyagi	ABPS Infrastructure Advisory Private Limited
14	Shri Tarun Aggarwal	ABPS Infrastructure Advisory Private Limited

**Minutes of the 2nd Meeting of the FOR Working Group on “Analysis of Factors
Impacting Retail Tariff and Measures to Address Them”
(Through Video Conferencing)**

Day / Date: Monday, 7th December, 2020

Chairperson, PSERC and Chairperson of the Working Group welcomed all members to the second meeting and requested Chief (RA), CERC and Convenor of the meeting to briefly update the Working Group on the deliberations in the previous meeting. List of participants is placed at *Appendix -I (Enclosed)*.

Chief (RA), CERC informed the Working Group that the observations made by Chairperson, WBERC in the previous meeting regarding the trading margin were inadvertently missed out in the minutes and could be incorporated in the minutes of this meeting. WBERC Chair reiterated that trading margin is in the domain of CERC and that CERC should consider fixing trading margin for long-term trade as well. The Working Group was also informed that the request of the Group for extension of time for submission of report and of technical assistance of consultants (consortium of KPMG, ABPS and CER/IITK) under the PSR program, was endorsed by the Chairperson of FOR.

Thereafter, representatives of M/s KPMG and M/s ABPS presented the ”Study on Analysis of Key Factors Impacting Electricity Tariffs” (*Annexure-I*) for select 12 States (copy enclosed). The presentation covered a detailed analysis on the impact of various components of average cost of supply (ACoS), including power purchase cost, transmission charges, fixed cost elements, coal prices, railway transport costs, transmission charges, RoE, competitive bidding in generation projects, benchmarking capital costs of FGD, capital cost, underutilisation of gencos, old thermal power plants, interest and finance charges, O&M charges, etc on the tariff.

1. TRANSMISSION COSTS:

Chairperson, OERC observed that the per unit power purchase cost excluding transmission charges has increased over the last three years. Chairperson, OERC and Chairperson GERC remarked that the analysis reveals FY 2016-17 as an exceptional year and suggested that

either it can be excluded from the study or the three years previous to 2016-17 could be included for analysis purpose. Chairperson, PSERC observed that some States have very low transmission charges as compared to others and it needs to be cross checked whether the tables including both CTU and STU charges uniformly. She further suggested that as the study is for the ACoS of the Discoms, only intra-State transmission charges should be considered while inter-State charges could ideally be included in the power purchase cost. Chairperson, OERC added that for the State of Odisha, transmission charges as shown in the presentation seem to be only the STU charges and that the CTU charges might have been included in power purchase cost.

Chief (RA), CERC stated that transmission charges have been segregated both for CTU and STU and the power purchase cost for the purpose of this study is the energy cost at bus bar of the generating stations. On the issue of transmission charges, Chairperson, OERC suggested to separately present STU charges for the States and energy handled by STU and total CTU charges and energy handled by CTU . Chairperson, WBERC added that the STU revenue curve of the State is almost flat but the CTU revenue curve is increasing very steeply. This has an implication on the energy charge and hence needs to be analysed in detail.

Coordinator (CER), IITK stated that there is a regulatory backlog. He informed that the net profit margin of PGCIL is in the range of 28% to 29% and for NTPC the same is in the range of 10% to 13% over the last five years. When it comes to competitive bidding PGCIL is quoting @ 50% of its own regulated costs .

The consultants stated that planning for creation of transmission and generation infrastructure is done to meet anticipated future demand growth . However, if the corresponding growth in demand and generation does not happen, the impact on account of such sunk costs increases. Chief (RA) , CERC added that there was no denying the fact that there has been significant investment on inter-state transmission during the last decade. However, it might not be fair to compare the cost of transmission on per unit basis. If the assets are created and investment is made, the resultant costs have to be recovered irrespective of their usage. Partner , KPMG stated that transmission infrastructure is created in the country as a whole and all States get intangible benefits from it. It is also required for the development of a unified centralised

electricity market at the national level. A mention was made of the changes in the CERC regulations on inter-state transmission charges and losses.

Chairperson, OERC stated that energy demand forecast of the discom is the basic data which is used by the STU and CTU for the creation of transmission infrastructure. He informed that for the State of Odisha, STU charges have been in the range of Re. 0.25 per unit for the last six years, CTU charges have grown at a CAGR of 17.2%. Thus, there appears to be some gap in forecasting and planning which needs to be looked into as this has huge implication for the States as far as tariff is concerned.

Member, PSERC stated that there is a difference in approach to investment decision for inter-state and intra-state transmission projects. Partial loading of green energy corridor may be one of the reasons for high transmission cost.

Partner, KPMG stated that the nature of infrastructure at CTU and STU is quite different as both have different objectives. Generally all infrastructure projects are built after due process and planning criteria. Transmission infrastructure is planned and built in advance and some temporary gaps in utilisation can happen. For example, there was a delay in construction of North-Eastern hydro projects while the transmission network came up before hand. Thus, comparing the inter State power flows including from hydro and RE with the State level flows can lead to fallacious conclusions. As the country has changed to a single frequency, and costs are indeed high, a clinical analysis needs to be carried to understand whether there were inefficiencies or other factors impacting costs of inter State transmission works.

Chairperson, JERC (Goa &UT) stated that the cost of infrastructure should be borne by the participants and participating States. He added that unless the infrastructure exists, power cannot flow. Transmission investment should be seen with a holistic perspective. Coordinator (CER), IITK informed that parameters for generation plants have been constant for the past 10 years and suggested that competitive bidding process for the development of transmission and generation assets at the national and State level will help to bring in cost-efficiency and should be the way forward for future projects.

Chairperson WBERC stated that the SERCs need to take call as to how much costs can be borne, if such transmission costs are equitably distributed. While initially, the postage stamp method was being followed, the method has now changed and Chairperson, CERC had assured the FOR members that an equitable system would come into effect and requested all SERCs to wait till end of January 2021 to assess the impact. He agreed with Coordinator, CER, IITK that return of more than 15% for transmission is quite high as there is no risk in the business.

Chairperson, TNERC stated that in future, distributed generation should be opted for. He informed that Tamil Nadu has an RPO of 9000 MW of which 5000 MW is remaining to be achieved. He opined that establishment of small-scale solar plants can be encouraged as it will exclude transmission costs because the same will be connected to feeders and big transmission lines will not be required. Chairperson, OERC suggested that the STU and CTU data should be analysed as there may be various reasons causing such variation. Member, PSERC added that projects which are not awarded on competitive basis are generally allotted to PGCIL based on their emergency and hence this also needs to be looked into if costs have to be reduced.

2. COAL

On the issue of coal grade slippage and GCV loss as presented through the Maharashtra case study, Chairperson, OERC enquired about the methods and procedure followed for sampling of coal for testing and suggested that the matter being very serious and impacting the bottom line of the generating company deserves immediate intervention. Chairperson, WBERC explained that as the nature of coal is different in different mines, there is a difference in GCV of coal depending on type of mining. He informed that unless the coal is washed, it will have major calorific differences. He further stated that the methods followed for testing and sampling are dated and a comprehensive view needs to be taken on how to frame a regulation which includes recommendation on the method of testing and drawing samples for testing.

3. O&M CHARGES

On the issue of O&M charges, Chairperson, PSERC suggested that a comparative statement of the best practices and measures in different States should be prepared.

4. ROE

On the issue of RoE, Coordinator, CER, IITK mentioned that as per the CER study (*Annexure-II*) using CAPM and multi-factor models and using comprehensive data for over 125 infrastructure companies between 1998-2018, it was estimated that the cost of equity for the conventional generation sector is in the range of 12.86% to 16.52%, on post-tax basis. WG. Chairperson, PSERC advised Coordinator, CER to circulate the study so as to discuss the same during the next meeting

5. STRANDED ASSETS – COSTS

Chairperson, OERC remarked that there were some points which were discussed during the previous meeting and the same were not covered in the presentation. For instance, costs of huge stranded generation assets that have an impact on ACoS. He therefore suggested to include this in the analysis. He added that such costs should be quantified in the tariff and suggestions should be made. He also underscored the need for rationalisation of transmission costs.

Chairperson, WBERC informed the group that, in his letter to Chairperson, CERC (which led to the formation of this working group), he had referred to incremental cost on account of under-utilisation of assets where the fixed cost is to be borne by the Discoms without getting commensurate benefit from the assets. He also suggested that this aspect should be analysed and recommendation be made as to whether the Central and State Govt can share such costs. The high fixed cost as a result of under-utilisation of assets and high tariff of transmission network is an outcome of wrong forecast and the consumer should be protected from the impact of such wrong forecast. He also stated that stranded asset is a major issue and both Centre and State should insulate the consumer from fixed cost liabilities without getting energy. Chairperson, OERC suggested that the stranded assets cost may not be reflecting in the book of accounts of Discom. He stated that In Orissa, the stranded assets cost is reflected in the books of accounts of GRIDCO only.

Chief (RA), CERC informed that the aspect of cost of stranded assets has been covered with reference to 12 States covered in the analysis. However, further study will be carried out to factor in the concerns raised by Chairperson, WBERC and OERC. He also added that a

separate working group of FOR has already been formed to address the larger issue of resource adequacy.

6. OLD COAL BASED PLANTS

On the issue of retirement of old coal-based plants, Partner, KPMG stated that phasing out such plants can lead to reduction in costs.

The group thanked M/s KPMG, ABPS for the presentation and decided to hold another meeting to discuss the factors affecting the tariff and suggest measures to reduce the impact of the same.

The meeting ended with vote of thanks to the Chair.

LIST OF PARTICIPANTS OF THE 2nd MEETING OF
FOR WORKING GROUP ON “ANALYSIS OF FACTORS IMPACTING RETAIL
TARIFF AND MEASURES TO ADDRESS THEM”

MONDAY, THE 7th DECEMBER, 2020.

S. No.	NAME	ERC
01.	Ms. Kusumjit Sidhu Chairperson	PSERC – In Chair
02.	Shri Anand Kumar Chairperson	GERC
03.	Shri M.K. Goel Chairperson	JERC (State of Goa & UTs)
04.	Shri U.N. Behera Chairperson	OERC
05.	Shri M. Chandrasekar Chairperson	TNERC
06.	Shri Sutirtha Bhattacharya Chairperson	WBERC
07.	Ms. Anjali Chandra Member	PSERC
08.	Dr. Sushanta K. Chatterjee Chief (RA)	CERC
09.	Ms. Rashmi Somasekharan Nair Dy. Chief (RA)	CERC
SPECIAL INVITEES		
10.	Shri Anish De, Partner	KPMG India
11.	Shri Ramit Malhotra	KPMG India
12.	Shri Archit Arora	KPMG India
13.	Shri Suresh Gehani, Director	ABPS Infrastructure Advisory Private Limited
14.	Shri Mrinal Navendu	ABPS Infrastructure Advisory Private Limited
15.	Shri Tarun Aggarwal	ABPS Infrastructure Advisory Private Limited
16.	Shri Anoop Singh, Coordinator, CER	IIT Kanpur
17.	Shri Kewal Singh	IIT Kanpur
18.	Shri Shreeyash	IIT Kanpur
19.	Shri Sumit Verma	IIT Kanpur

20.	Shri Rakesh Shukla	IIT Kanpur
21	Shri P.P. Kulkarni	IIT Kanpur
22	Shri Himanshu Anand	IIT Kanpur
23	Shri Sanjeev Tinjan Asst. Chief (RA)	CERC
24	Shri Ravindra Kadam Advisor (RE)	CERC
25	Shri Saurabh Derhgaven Principal Research Officer	CERC
36	Shri Manvendra Pratap Research Officer	CERC

Study on Analysis of **Key Factors Impacting** **Electricity Tariffs**

11th December 2020



Contents

01

Background and objective

02

Structure of the discussion

03

Analysis of select parameters

04

Conclusion

Background and objective

- ❑ Retail supply tariffs are designed to recover the cost incurred across the entire value chain i.e. generation, transmission, distribution and retail supply.
- ❑ It depends on multiple factors such as like cost of generation- fixed costs including O&M expenses, fuel expense, taxes and duties, etc., cost of transmission- capital and operating costs, Return on Equity (ROE), network maintenance expenses, etc. and cost of distribution- network development, O&M, distribution losses, metering, billing & collection expenses, etc.
- ❑ Hence, it is proposed to conduct a study on “**Analysis of key factors impacting electricity tariffs**” to identify measures to reduce retail supply tariffs

The proposed study will:

- a) Identify the impact of key external and internal factors on electricity tariff including the likely impact of recent developments in the sector, and
- b) Suggest policy and regulatory measures to reduce electricity tariffs

Structure of discussion

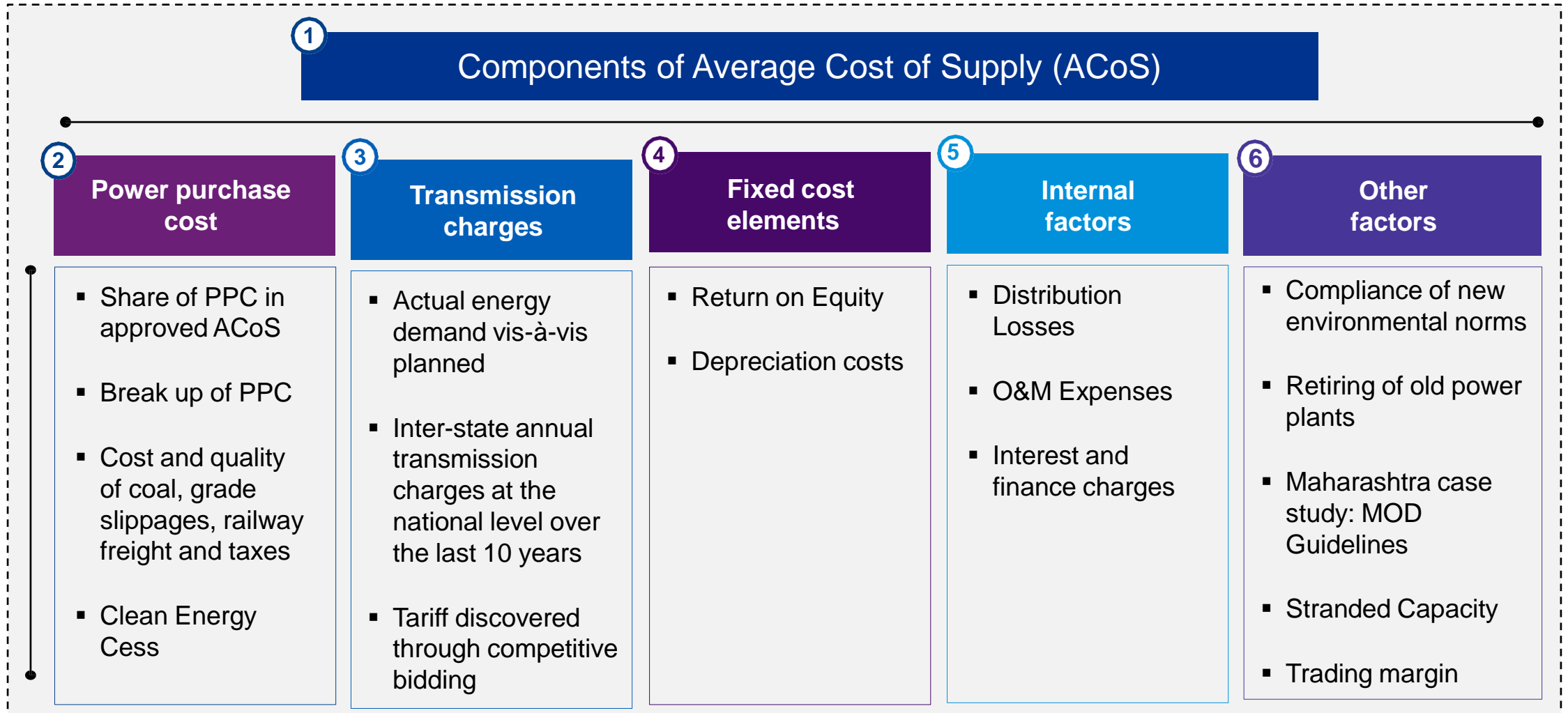

Power purchase cost



Share of PPC in approved ACoS



Power purchase trend

Hypothesis: PPC constitutes major share of ACoS and the share has not increased over the last 4 years

- ❑ PPC (excluding transmission charges) accounts for ~67% to 78% of the total ACoS for 12 states* over the last 4 years

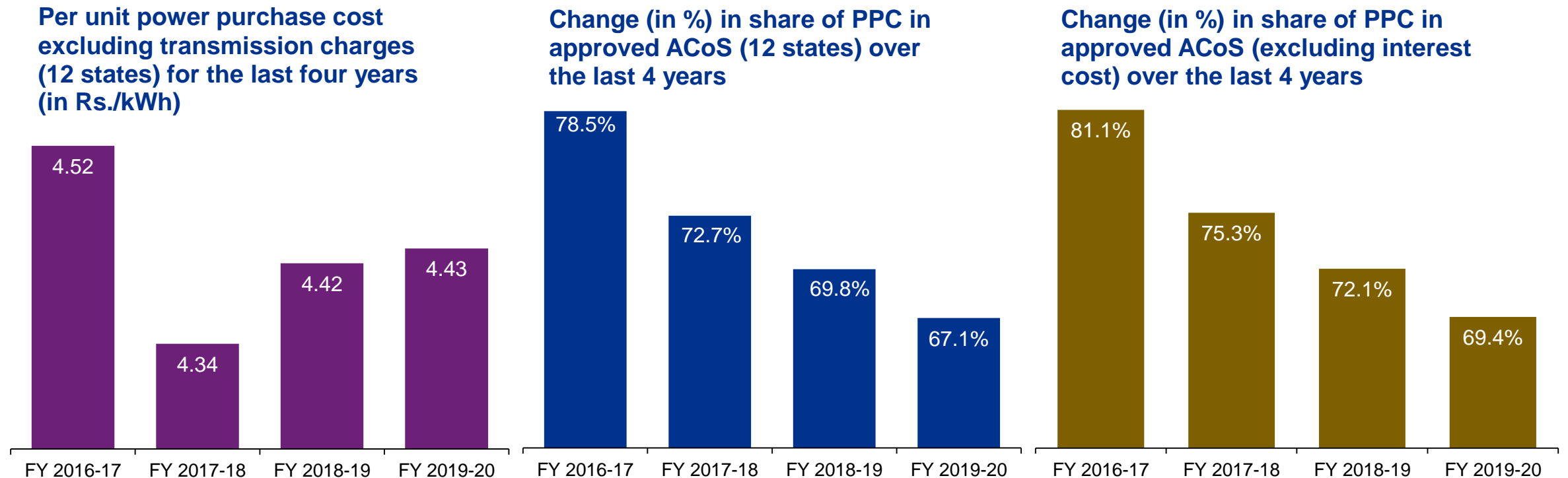

The power purchase costs has reduced marginally over the last 4 years. The share of PPC in approved ACoS has reduced from 78% to 67%.

Source: Tariff orders issued by respective state commissions for the last 5 years

State-wise PPC excluding TC for last 4 years

ACoS ABR gap for last 4 years

*The selected 12 states identified in consultation with the FOR account for 50% of the total consumption in the country

Share of cost components (in %) of ARR

Change in share of cost components over the last 4 years

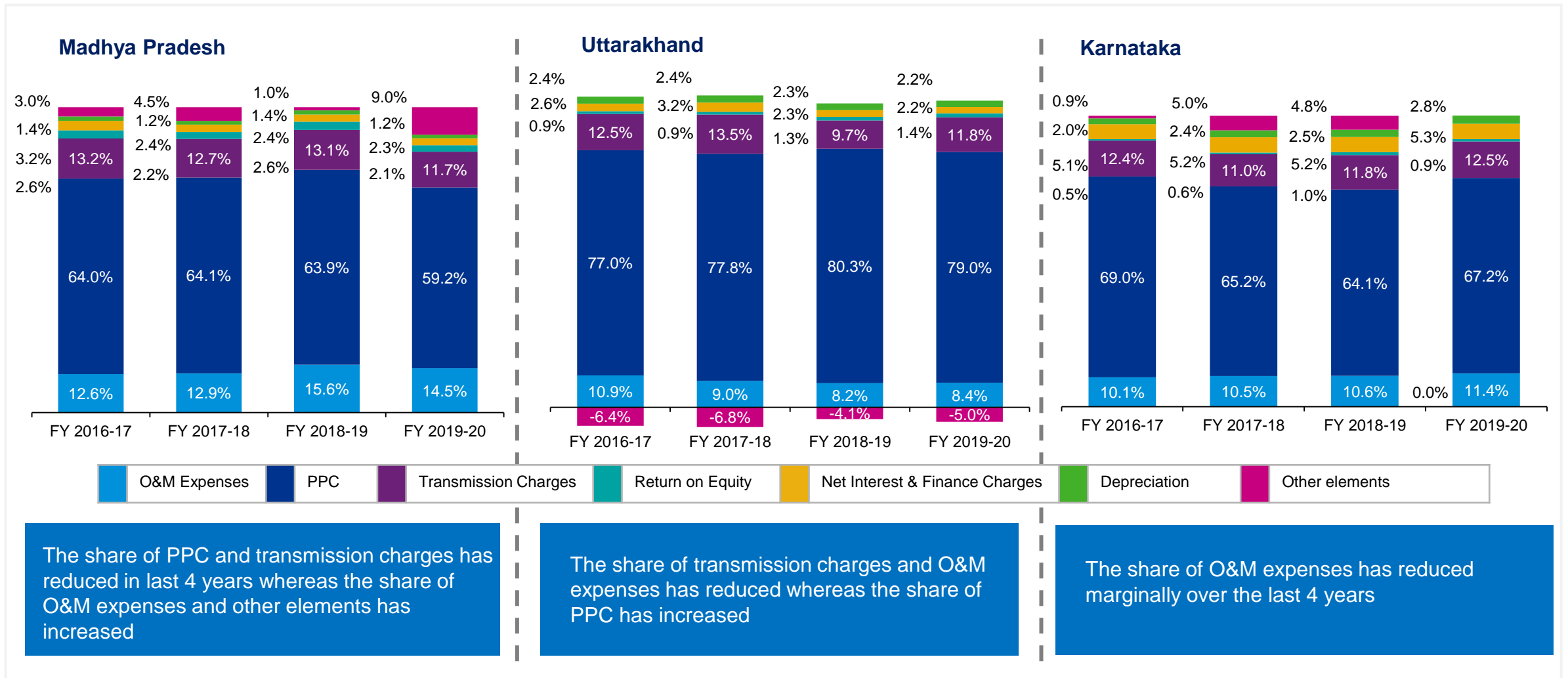

Source: Tariff orders issued by respective state commissions for the last 4 years;

Share of cost components (in %) of ARR

Change in share of cost components over the last 4 years

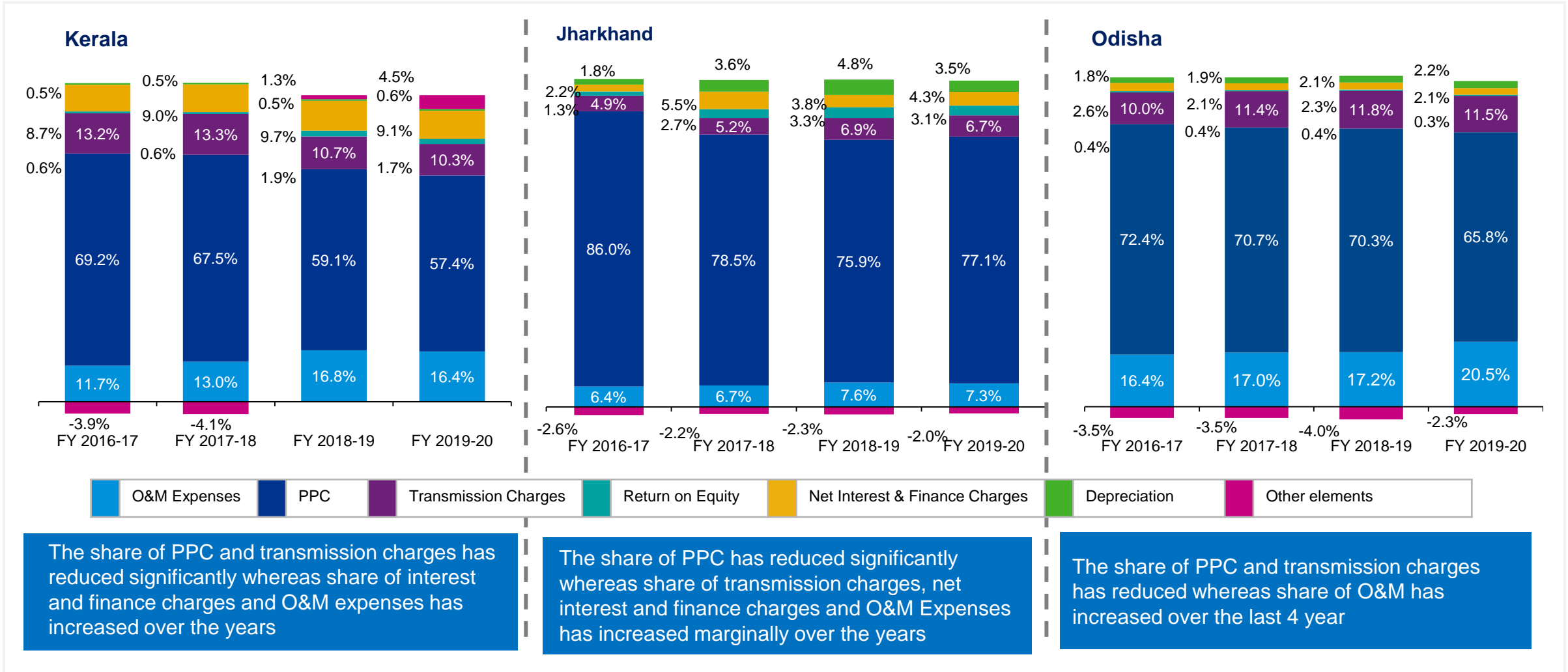

Source: Tariff orders issued by respective state commissions for the last 4 years;

Share of cost components (in %) of ARR

Change in share of cost components over the last 4 years

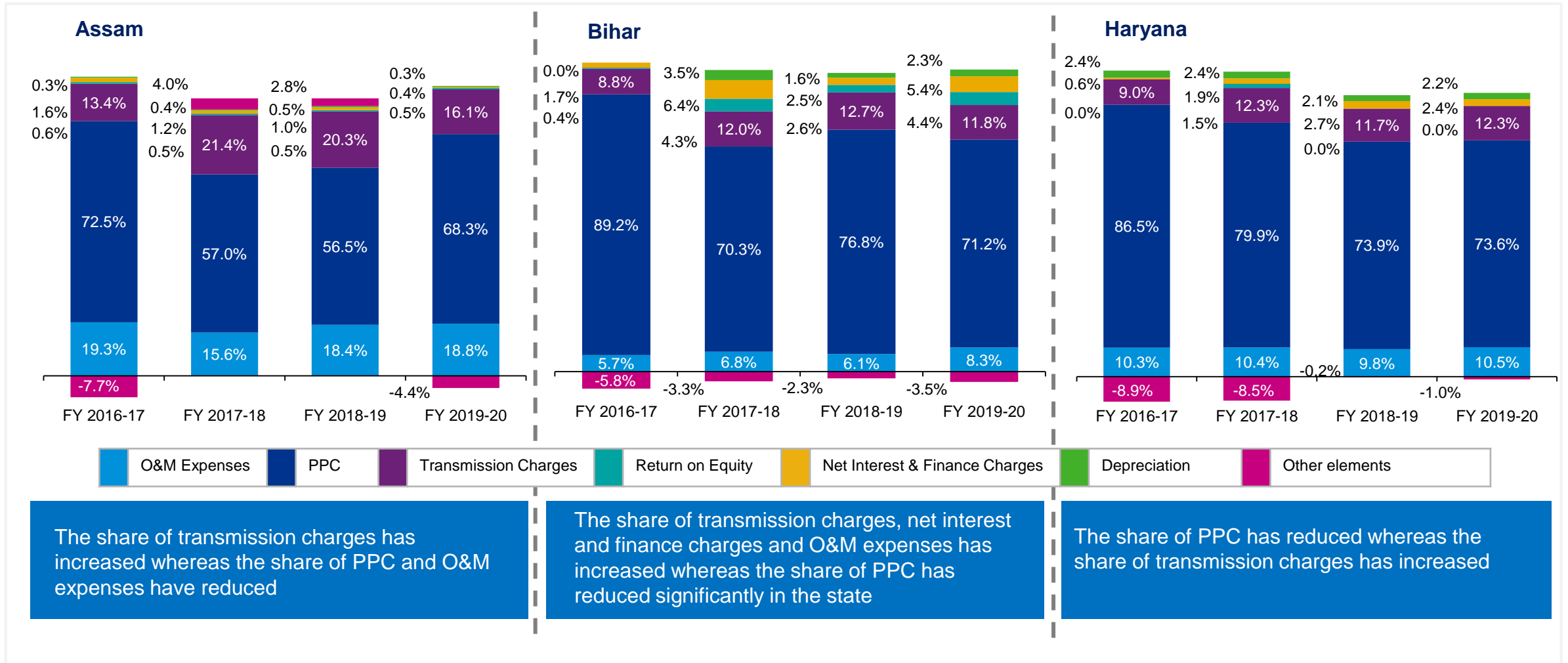

Source: Tariff orders issued by respective state commissions for the last 4 years;

Share of cost components (in %) of ARR

Change in share of cost components over the last 4 years

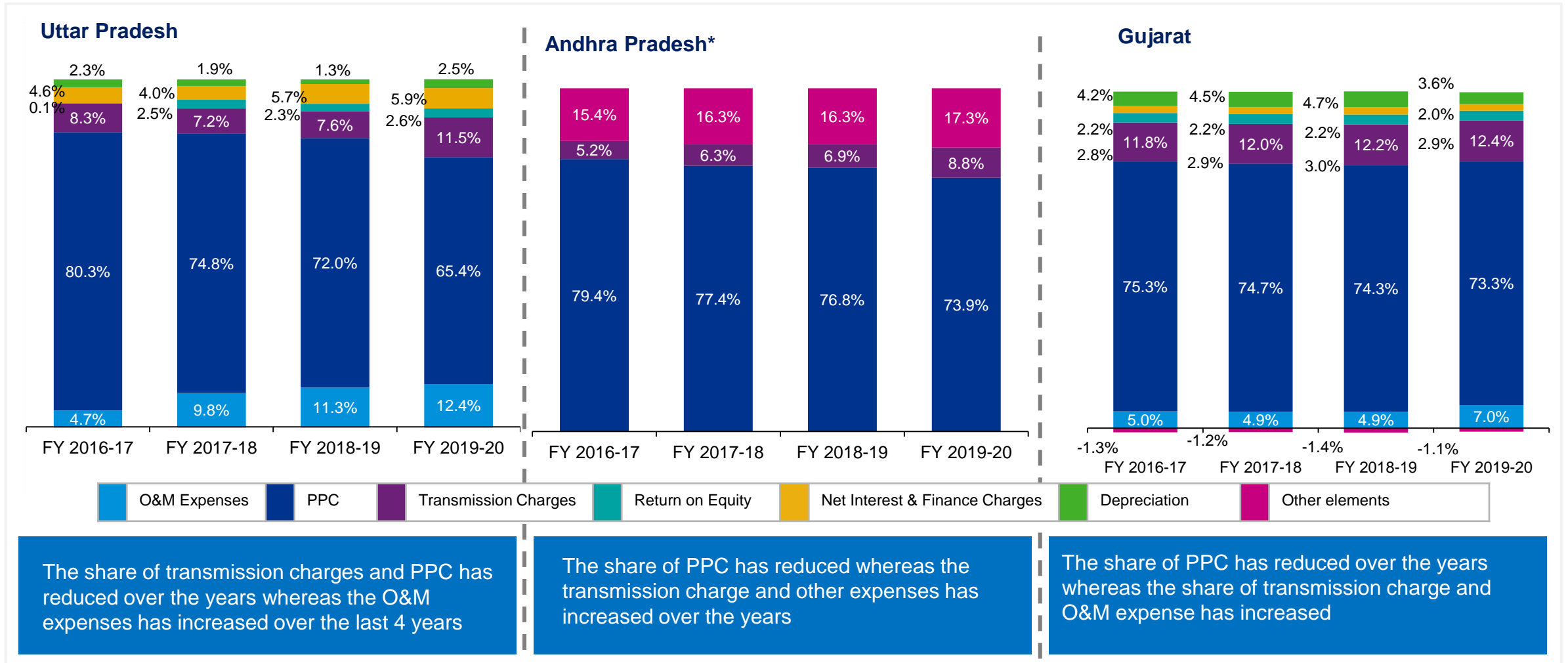

*For the state of Andhra Pradesh, net ARR is estimated as sum of PPC, transmission charges and other elements of ARR

Source: Tariff orders issued by respective state commissions for the last 4 years;

Summary: Power purchase trend

Hypothesis: PPC constitutes major share of ACoS and the share has not increased over the last 4 years

- ❑ PPC accounted for **~67% to 78% of the ACoS** over the last 4 years for 12 states. However, per unit PPC has reduced during the same period.
 - Share of PPC in approved ACoS has reduced across states (except for the states of Uttarakhand)
 - In Uttarakhand, the share of PPC has increased mainly on account of new PPAs with gas-based power plants

- ❑ Major reason for reduction in share of PPC is the **increase in contribution of other cost components** (such as O&M costs, depreciation, ROE, etc.) to the approved ACoS

**Power purchase break-up,
cost and quality of coal,
grade slippages, increasing
taxes, railway freight**



Power purchase break up for Madhya Pradesh for FY 2018-19

❑ PPC (excluding transmission charges) accounts for ~64% of the total ARR for FY 2018-19

Particular	Allocation (MW)	Quantum (MU)	FC (Rs. Crore)	VC (Rs. Crore)	FC (Rs./kWh)	VC (Rs./kWh)	Total Cost (Rs. Crore)	Total Cost* (Rs./kWh)
Central Sector	4,753	23,212	2,801	3,957	1.21	1.70	6,758	2.91
State Sector	12,080	55,213	7,064	8,497	1.28	1.54	15,561	2.82
Renewables	3,687	6,041	-	3,338	-	5.53	3,338	5.53
Others	55	99	4	-	0.40	0.00	4	0.40
Surplus Power		18,716					(4,866)	(2.60)
Revenue for SEZ							(28)	
MPPMCL Cost							(480)	
Total Power Purchase Cost	20,575	103,282	9,869	15,792	0.96	1.53	20,287	1.96

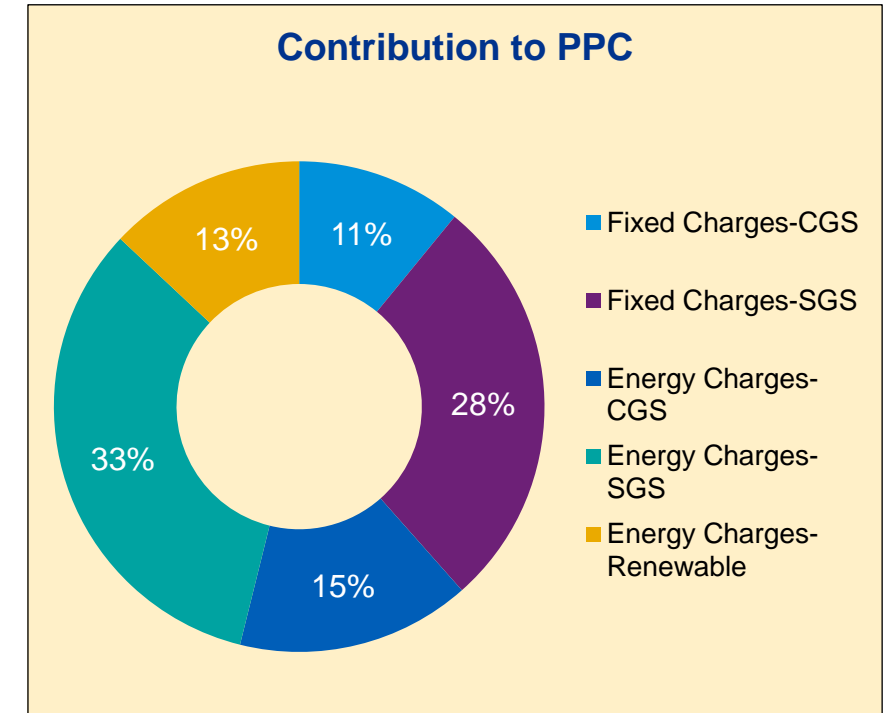

- Fixed charges contributed about 40% of PPC and energy charges contributed about 60%
- In the overall ARR, fixed charges contribute around 25% and energy charges contribute around 39% of ARR

Power purchase break up for Uttarakhand for FY 2018-19

❑ PPC (excluding transmission charges) accounts for ~80% of the total ARR for FY 2018-19

Particular	Allocation (MW)	PP at State periphery (MU)	FC (Rs. Crore)	VC (Rs. Crore)	VC (Rs./kWh)	Total Cost (Rs. Crore)	Total Cost* (Rs./kWh)
Central Sector	1,018	4,926	569	1,033	2.10	1,602	3.25
State Sector	1,682	7,511	642	1,606	2.14	2,248	2.99
Renewables	209	1,989	-	701	3.53	701	3.53
Water Tax	-	-	-	233	-	233	-
Total Power Purchase Cost	2,909	14,426	1,212	3,573	2.48	4,785	3.32

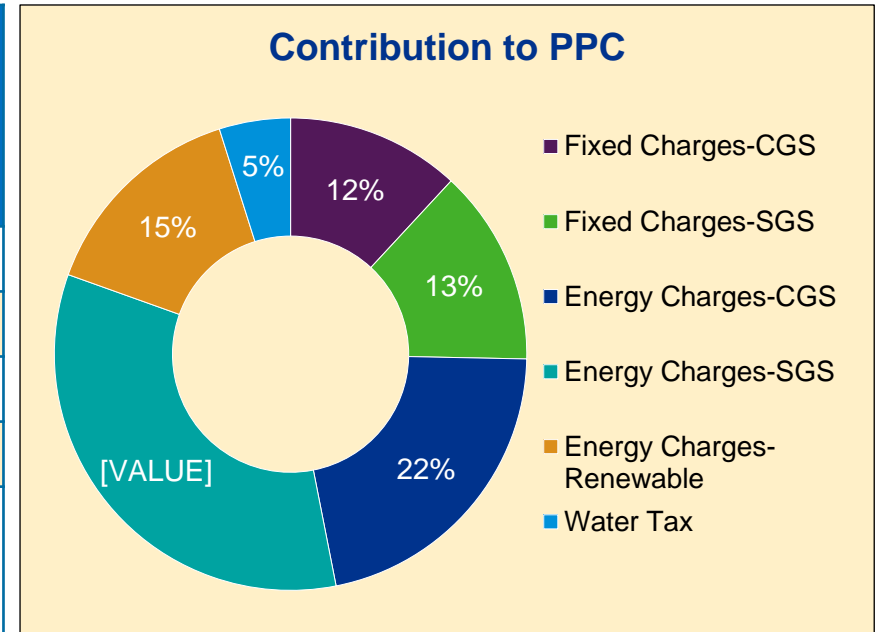

- Fixed charges contributed around 25% of PPC and energy charges contributed about 70% to PPC
- Variable charges for Uttarakhand is high mainly due to purchase from gas-based stations

Source: Tariff Order

*Total Cost per unit of Power Purchase (Rs./kWh)
FC: Fixed Charges, VC: Energy Charges

Coal price hike

Hypothesis: Cost of coal for TPPs has increased disproportionately as compared to other cost components

- Price per tonne for most grades of coal has increased since January 2018, directly impacting power purchase cost of power distribution companies

Coal Grade	GCV (Kcal/Kg)	Coal Price (Rs/Tonne)		
		June 2013- May 2016	June 2016- Dec 2017	Jan 2018- present
G1	Above 7000	Price shall be increased by Rs. 150/- per tonne over and above the price applicable for GCV band exceeding 6700 but not exceeding 7000 Kcal/Kg, for increase in GCV by every 100 Kcal/Kg		Price shall be increased by Rs. 100/- per tonne over and above the price applicable for GCV band exceeding 6700 but not exceeding 7000 Kcal/Kg, for increase in GCV by every 100 Kcal/Kg
G2	6701-7000	4870	3450	3288
G3	6401-6700	3890	3210	3144
G4	6101-6400	3490	3000	3000
G5	5801-6100	2800	2750	2737
G6	5501-5800	1600	1900	2317
G7	5201-5500	1400	1600	1926
G8	4901-5200	1250	1420	1465
G9	4601-4900	970	1100	1140
G10	4301-4600	860	980	1024
G11	4001-4300	700	810	955
G12	3701-4000	660	760	886
G13	3401-3700	610	720	817
G14	3101-3400	550	650	748
G15	2801-3100	510	600	590
G16	2501-2800	450	530	504
G17	2201-2500	400	470	447

- Increase in G11 – G14 Grade in Jan 2018 with respect to June 2016 is in range of 13-18%

Coal grade used for electricity generation

Railway transportation charges

Base freight charges of coal and coke have increased by 21% in Jan 2018 and 9% in Nov 2018 impacting the power purchase cost

Freight rate- Trainload for Coal and coke

Figures in Rs./tonne

Distance slab (in kms)	2016	July-sept 2017	Oct 2017-Jan 2018	Jan 2018*	November 2018#
1-100	165	179	165	199	216
500-600	844	949	935	1129	1228
1000-1020	1371	1476	1462	1765	1920
1500-1510	1970	2076	2061	2489	2707
2000-2010	2249	2354	2340	2825	3073
2500-2510	2524	2630	2615	3158	3434
3000-3010	2799	2905	2890	3490	3795

*Adjustment in base freight rates effective from 9th January 2018

Source: <http://www.indianrailways.gov.in>

#http://www.indianrailways.gov.in/railwayboard/uploads/directorate/traffic_comm/downloads/Freight_Rate_2018/RC_19_2018.PDF

Indicative coal prices and railway freight

Comparison of actual coal prices and railway freight vis-à-vis indicative prices linked to inflation

Comparison of actual coal prices (in Rs./Tonne) vis-à-vis indicative prices linked to inflation

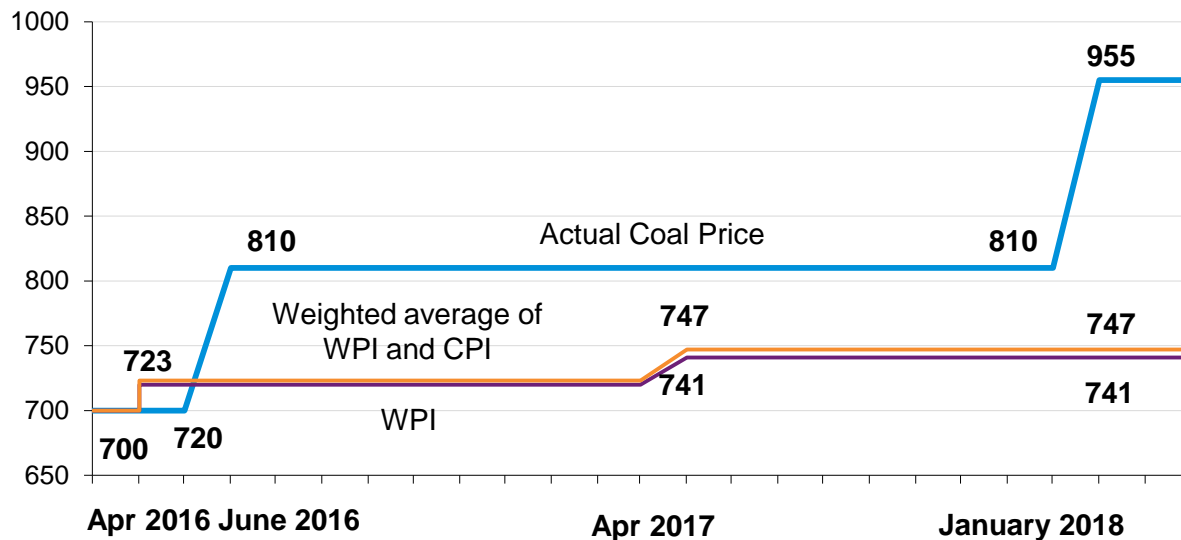

Comparison of actual railway freight (in Rs./Tonne) vis-à-vis indicative prices linked to inflation

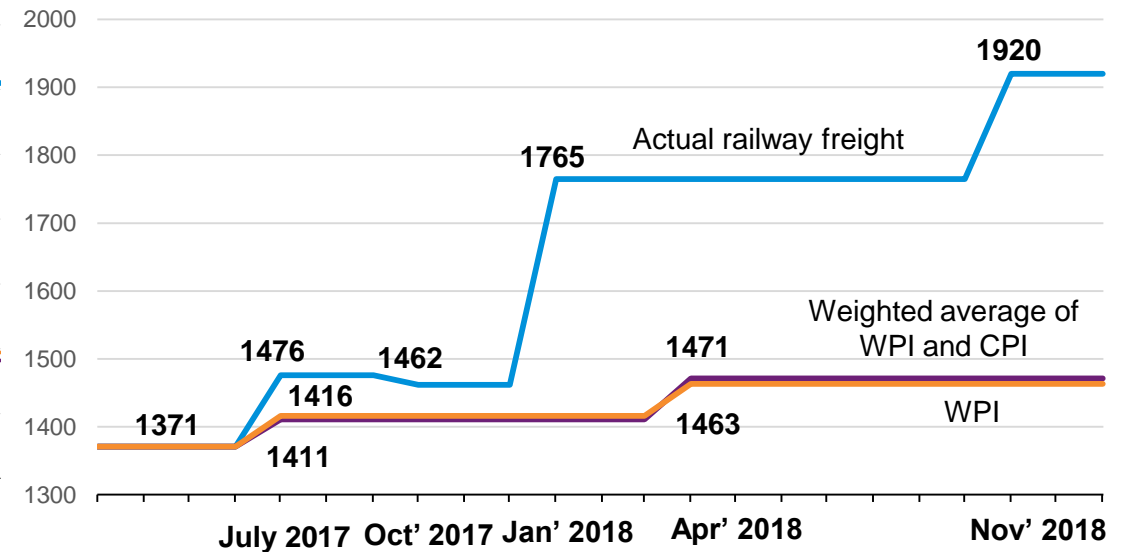

- Actual coal prices were about ~28% higher in Jan' 2018 as compared to price based on WPI and wt. avg. of WPI & CPI

- Actual railway freight was about ~30% higher in Nov' 2018 as compared to freight based on WPI and wt. avg. of WPI & CPI

Railway freight for distance slab 1000-1020 km considered for the analysis

Source: Inflation Rate: WPI index (<https://rbidocs.rbi.org.in/rdocs/AnnualReport/PDFs/4TCE9C7C09660A43A7824384F0E4661D7F.PDF>)

O&M charges (<http://www.cercind.gov.in/2020/orders/496-TT-2019.pdf>)

Clean energy cess

Description	Unit	Gol, Ministry of Finance Notification dated 22 June 2010	Gol, Ministry of Finance Notification dated July 2014	Gol, Ministry of Finance Notification dated 28 Feb 2015	Gol, Ministry of Finance Notification dated March 2016
Clean energy cess	Rs./Tonne	50	100	200	400

Source: <http://www.coal.nic.in>, www.arthapedia.in

https://coal.nic.in/sites/upload_files/coal/files/curentnotices/cbec140710_0_0.pdf <https://timesofindia.indiatimes.com/budget-2016/industry/Union-Budget-2016-Govt-doubles-Clean-Energy-Cess-on-coal-to-Rs-400-per-tonne/articleshow/51191619.cms> Source: <http://www.indianrailways.gov.in>

Contribution of fuel cost, railway freight and cess to cost of generation for a sample station in Madhya Pradesh

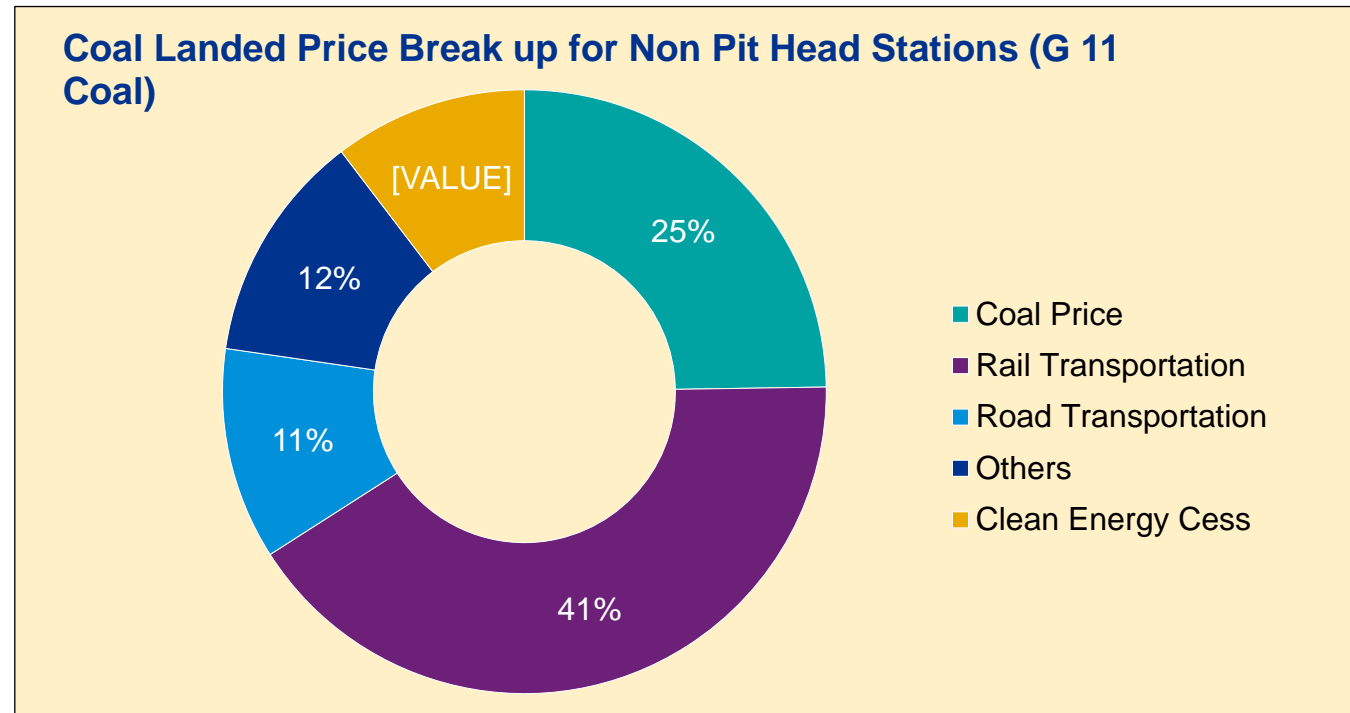

For non pit-head stations,

- Transportation Cost accounts for around 50% of total landed cost of coal
- Clean energy cess contributes to around 10% of total landed cost of coal which will be around 12-20% for landed cost of coal for pit head stations

Impact of reduction in clean energy cess on ACoS

Parameter	Value
Total Coal and Lignite Consumption for Power Generation in FY 2017-18 (as per MOSPI Report)	614.53 Million Tonnes
Total Annual Thermal Generation in FY 2017-18 (CEA Report)	1,037 Billion Units
Annual savings due to reduction in Clean Energy Cess by Rs 100/MT	Rs 6,145 Crore
Impact of Rs 100/MT reduction in Clean Energy Cess on per unit energy charge	Around 6 paise per unit (approximately 3%)
Impact of Rs 50/MT reduction in Clean Energy Cess on per unit energy charge	Around 3 paise per unit (approximately 1.5%)

Coal GCV loss: Maharashtra case study

Actual GCV for FY 2018-19 (MSPGCL)

Source	GCV (at Loading End - EB) in kcal/kg	GCV As Received (EB) in kcal/kg	Grade Slippage (kcal/kg)	GCV As Received (After Moisture Correction) in kcal/kg	Moisture Loss (kcal/kg)	Total GCV Loss (kcal/kg)	Quantum (MT)	Proportion (%)
	A	B	C=B-A	D	E=B-D	F=C+E		
WCL	3954	3575	379	3270	305	684	2,58,69,068	74.0%
MCL	3514	3364	150	3086	278	428	27,03,647	7.7%
SECL	3921	3688	233	3343	345	578	16,39,826	4.7%
SECL	4083	3651	432	3380	271	703	47,48,426	13.6%
MSPGCL-Wtd. Avg.	3936	3574	362	3274	300	662	3,49,60,968	

- ❑ It can be observed from the data that the total GCV loss between as billed basis and as received basis is 662 Kcal/kg, which consists of 362 kcal/kg on account of Grade Slippage and 300 kcal/kg on account of Moisture loss.
- ❑ MERC Tariff Regulations 2019 specifies that the GCV loss between GCV as billed and GCV as received would be allowed at actuals subject to maximum of 300 kcal/kg.

Coal GCV loss: Maharashtra case study

Actual GCV for FY 2019-20 (April to Oct 2019.)

Source	GCV (at Loading End -EB) in kcal/kg	GCV As Received (EB) in kcal/kg	Grade Slippage (kcal/kg)	GCV As Received (After Moisture Correction) in kcal/kg	Moisture Loss (kcal/kg)	Total GCV Loss (kcal/kg)	Quantum (MT)	Proportion (%)
	A	B	C=B-A	D	E=B-D	F=C+E		
WCL	4115	3491	624	3168	323	947	12,993,932	72.0%
MCL	3537	3565	-28	3225	340	312	1,390,724	7.7%
SECL	3814	3752	62	3404	348	410	732,058	4.1%
SCCL	3430	3149	281	2900	249	530	2,938,306	16.3%
MSPGCL-Wtd. Avg.	3947	3452	495	3138	313	808	18,055,020	

- ❑ GCV loss between As Billed and As Received is 808 kcal/kg for MSPGCL as a whole, comprising 495 kcal/kg towards Grade Slippage and 313 kcal/kg towards moisture correction.
- ❑ The GCV loss for FY 2019-20(April to October) is higher than FY 2018-19,because losses are higher during the monsoon season.

Coal GCV loss: Maharashtra case study

Observations of MERC on GCV of Coal

GCV loss between as billed and as received
for FY 2018-19

**662
kcal/kg¹**

GCV loss between as billed and as received
for FY 2019-20

**792
kcal/kg²**

❑ The Commission observed that if entire GCV loss is allowed, then there will be no incentive for MSPGCL to control the GCV loss.

❑ Hence in addition to the relaxation of 300 kcal/kg, the Commission decided to provide extra relaxation on account of GCV for the subsequent years, provided in the table below:

Particulars	GCV Relaxation as per Regulations	Additional GCV relaxation	Total Relaxation in GCV
	kcal/kg	kcal/kg	kcal/kg
FY 2020-21	300	225	525
FY 2021-22	300	200	500
FY 2022-23	300	175	475
FY 2023-24	300	150	450
FY 2024-25	300	125	425

¹ 362 kcal/kg - Grade Slippage and 300 kcal/kg-Moisture correction

² 492 kcal/kg –Grade slippage and 300 kcal/kg-Moisture correction

Impact of GCV loss on energy charge

Sample Impact of GCV Loss on Energy Charges

Sample Impact of GCV	Unit	GCV-3408	GCV-3308	GCV-3208
Installed Capacity	MW	210	210	210
Plant Load Factor (%)	%	85.00%	85.00%	85.00%
Gross Generation	MU	1563.7	1563.7	1563.7
Auxiliary Consumption	%	11.0%	11.0%	11.0%
Net Generation	MU	1392.3	1392.3	1392.3
Station Heat Rate	kCal/kWh	2450	2450	2450
Secondary Fuel Oil Consumption	ml/kWh	2	2	2
GCV of Oil	kCal/litre	10589	10589	10589
GCV of Coal	kCal/kg	3,408.0	3,308.0	3,208.0
Price of coal	Rs./MT	3410	3410	3410
Energy Charge Rate (Ex-bus)	Rs./kWh	2.79	2.88	2.97
Reduction in Energy Charges (in %)			3%	3%

❑ Every 100 kcal/kg GCV loss impacts the Energy Charges by 3%

Transmission charges



Transmission

Comparison of actual energy requirement and peak demand starting FY 2016-17 vis-à-vis planned (as per 19th EPS)

Actual and projected energy requirement (in BUs) starting FY 2016-17 at an all India-level

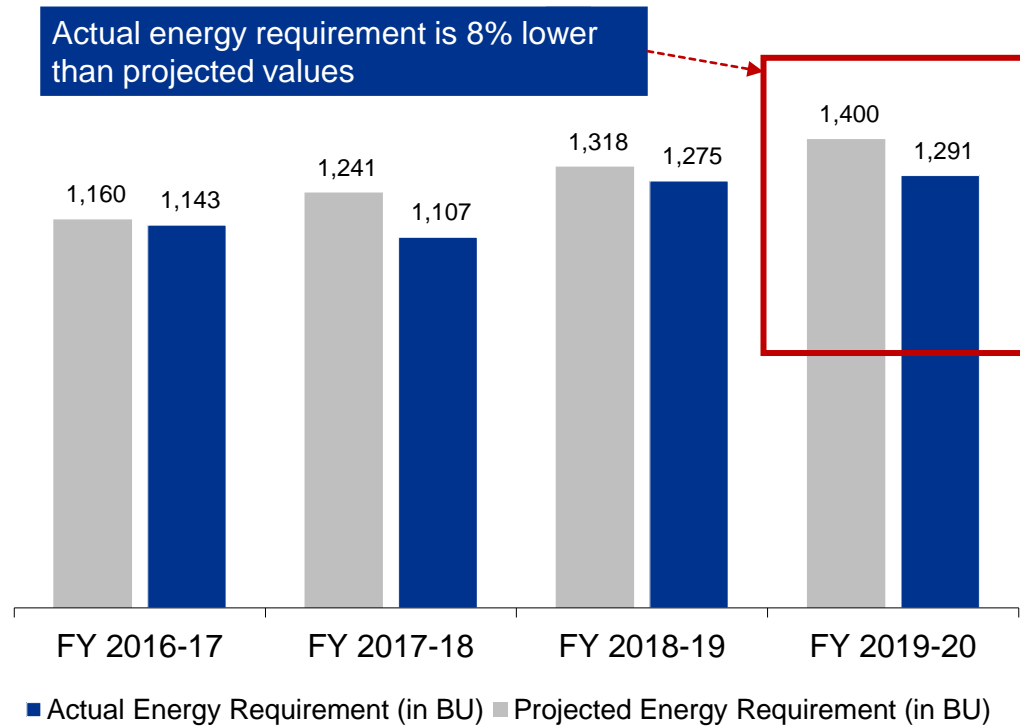

Actual and projected peak demand (in MWs) starting FY 2016-17

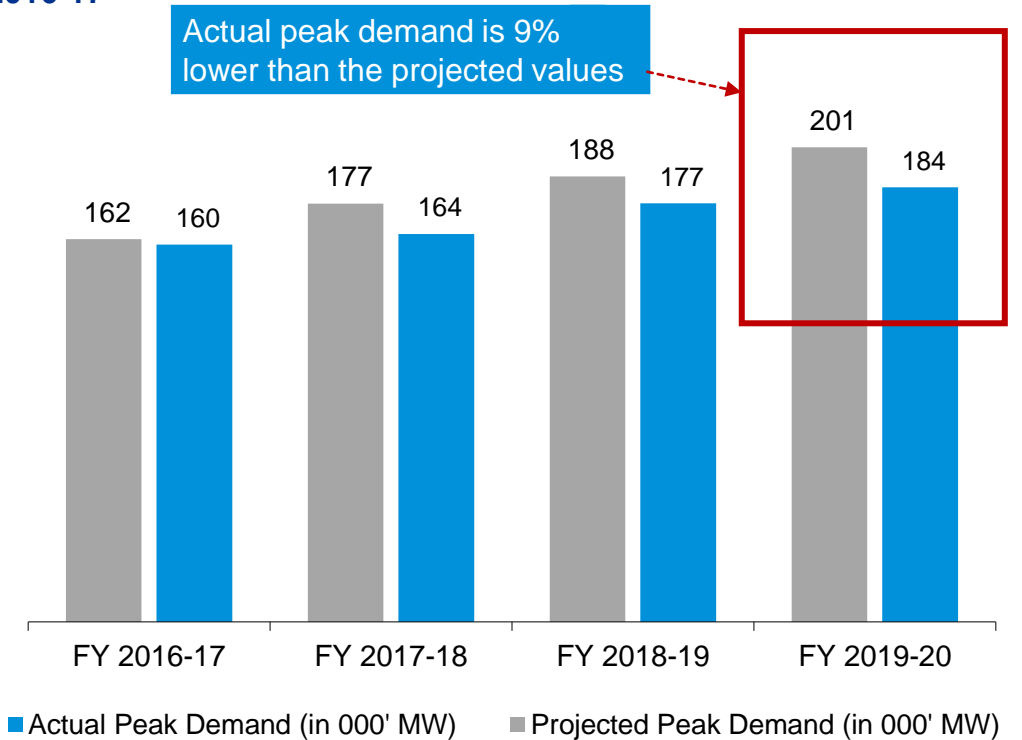

- Energy and peak demand in the country was about 2-12% less than projected (as per the 19th EPS)
- Transmission assets were developed based on projections

Transmission capacity

Historical trend of transmission capacity

Cumulative transmission assets (inter-state and intra-state)

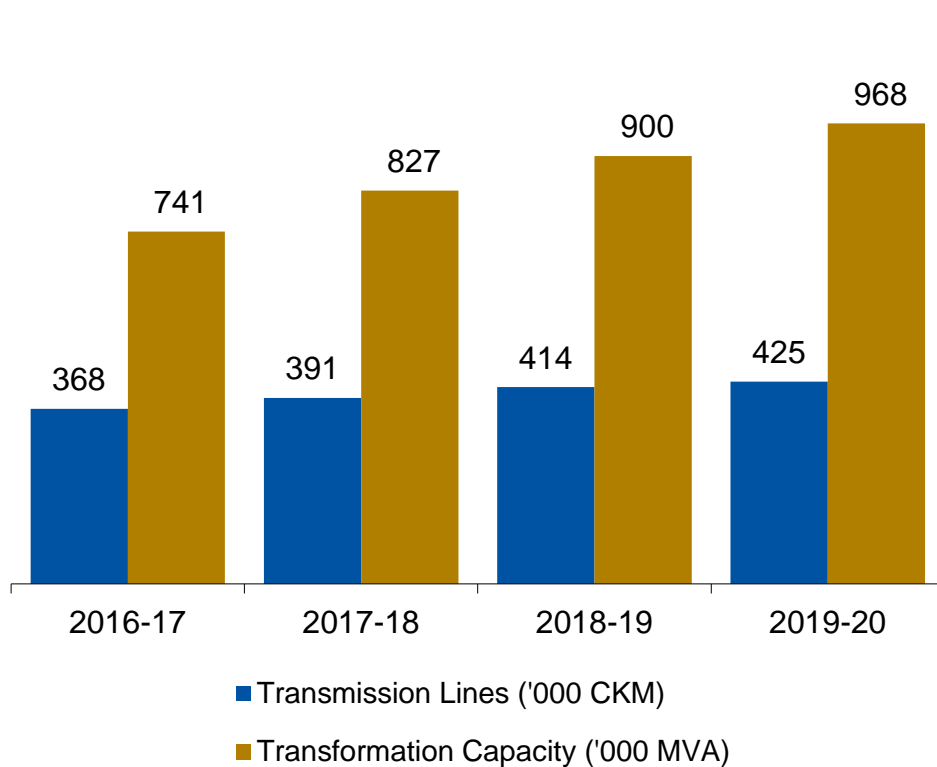

Inter-state transmission capacity addition vis-à-vis planned

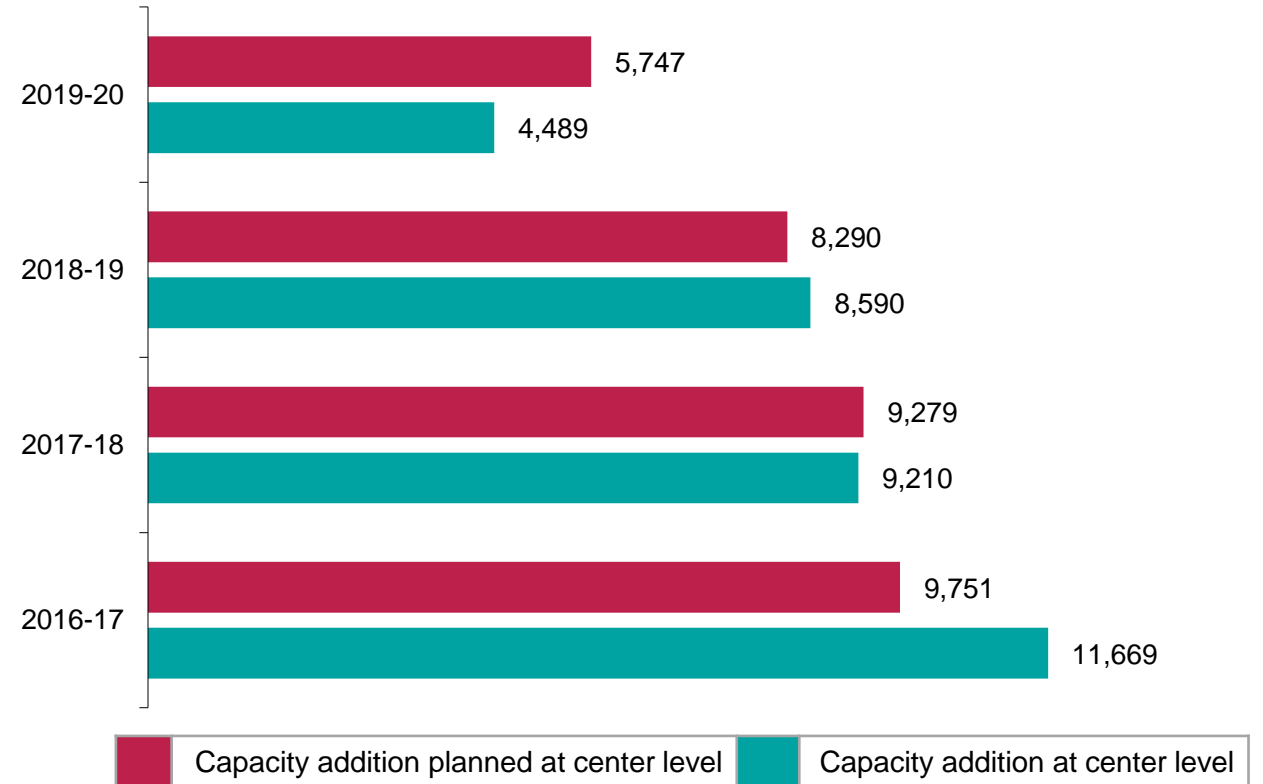

Transmission capacity has increased as planned with 5% CAGR Growth (CKM) in lines and 9% CAGR Growth in transformation capacity

Transmission charges

Voltage wise capacity addition vis-à-vis planned

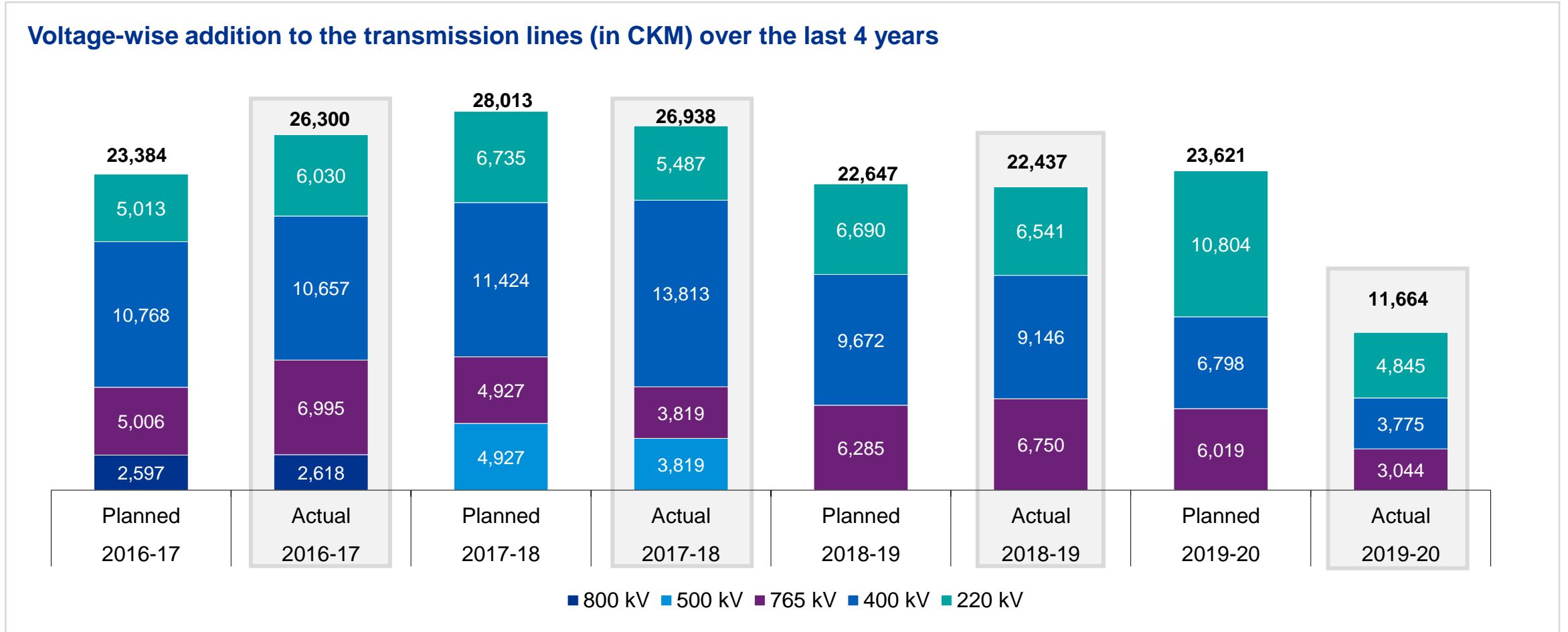

Capacity addition of 400 kV transmission lines accounted for 43% of the cumulative addition over the last 4 years

Power procurement from central generating stations

Actual power purchased from CGS vis-à-vis approved

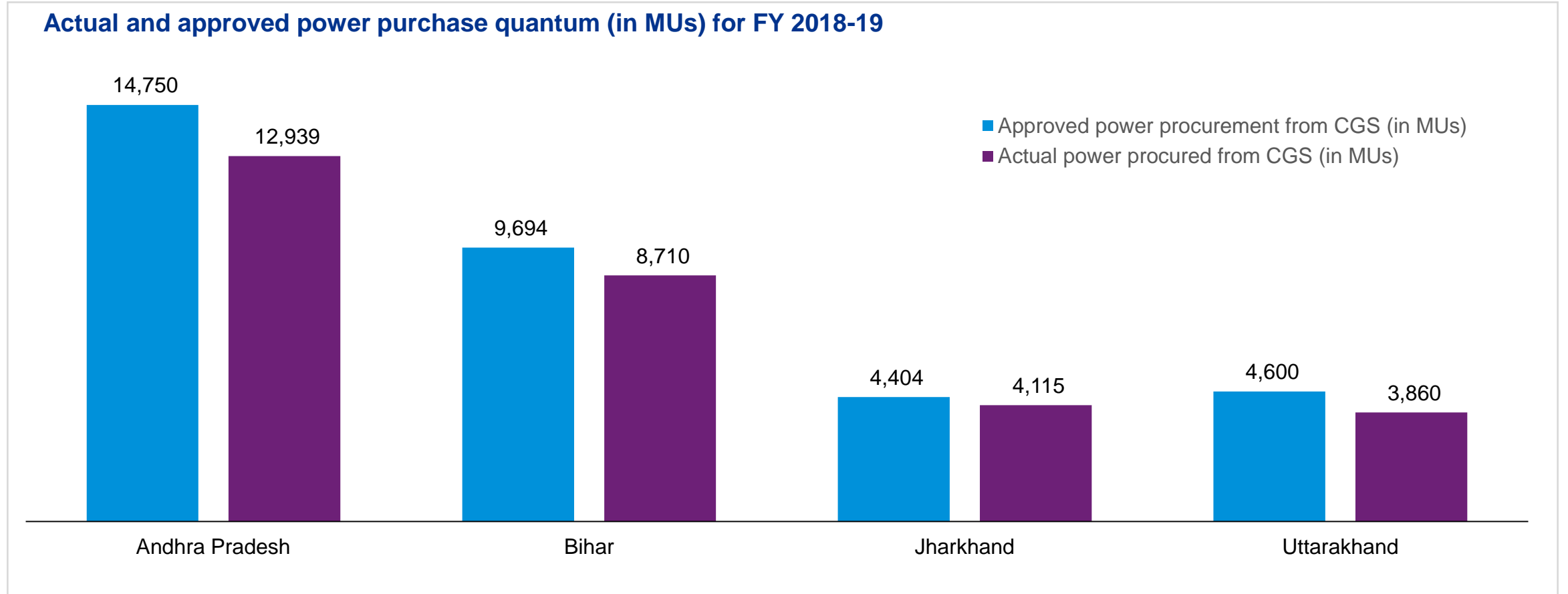

• Uttarakhand, Andhra Pradesh, Bihar and Jharkhand procured about ~84%-93% of the booked capacity from central sector plants for FY 2018-19

Annual transmission charges

Annual transmission charges (Rs. 000' Crore) *

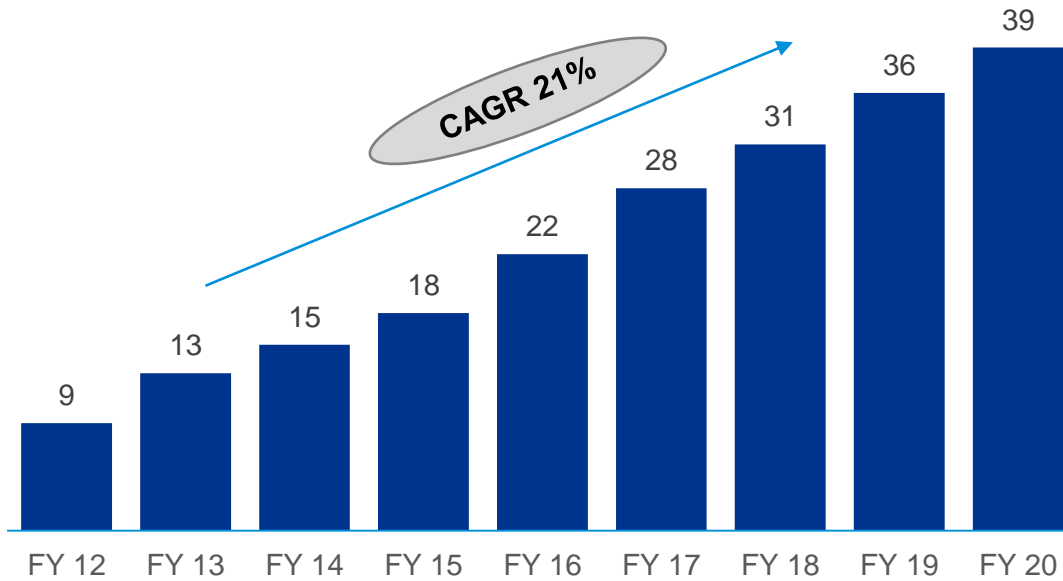

Annual transmission charges (Rs. 000's Cr) have increased at a CAGR 21% over the last 9 years

Transmission charges per unit of power generated from CGS (Rs./unit)*

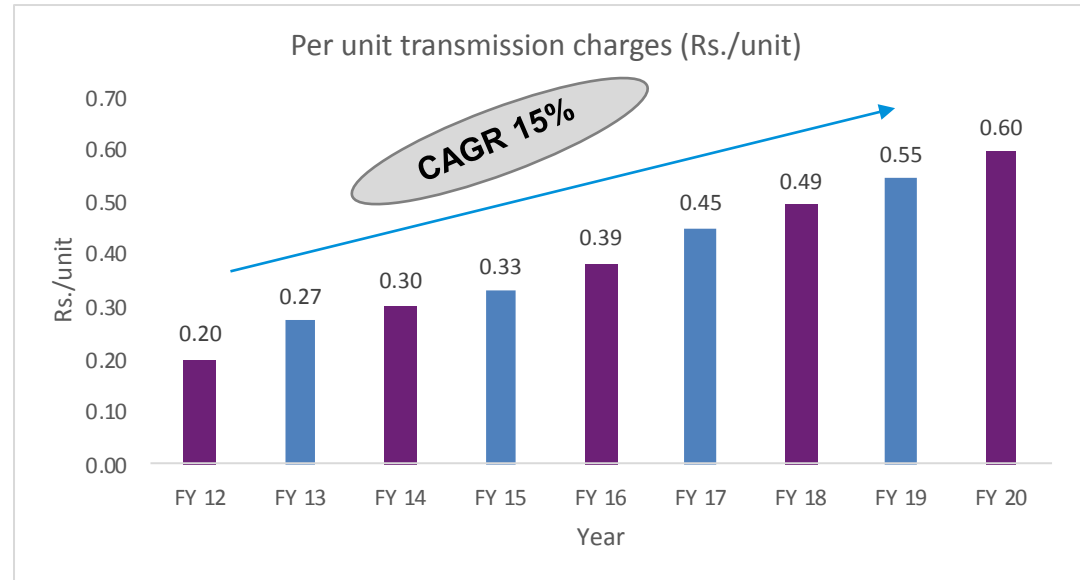

Transmission charges per unit power generated from CGS have increased at a CAGR of 15% over the last 9 years

Annual transmission charges and power procured from ISGS

*Source: CEA monthly generation report, CERC short term market monitoring report for FY 2019-20

Inter & Intra-State Transmission Charges (Rs. Crore & Rs./kWh)

Change in Transmission Cost over the last 4 years

Odisha: Transmission Charges (Rs. Crore)

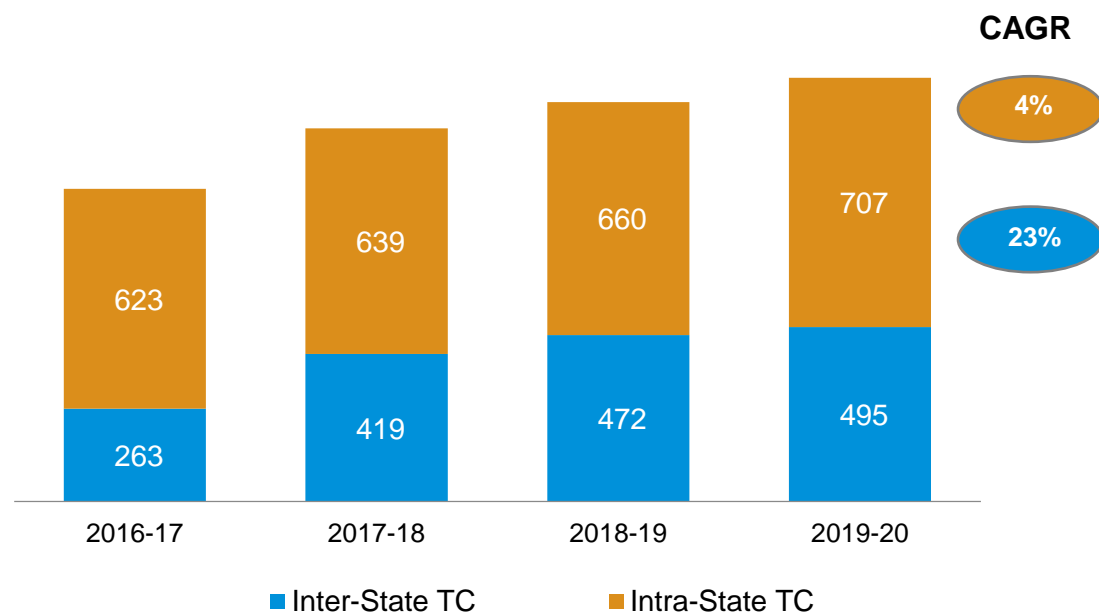

The share of inter-state transmission charges has increased @ 23% CAGR in last 4 years whereas the share of intra-state transmission charges has increased @ 4% CAGR only.

Odisha: Transmission Charges (Rs./kWh)

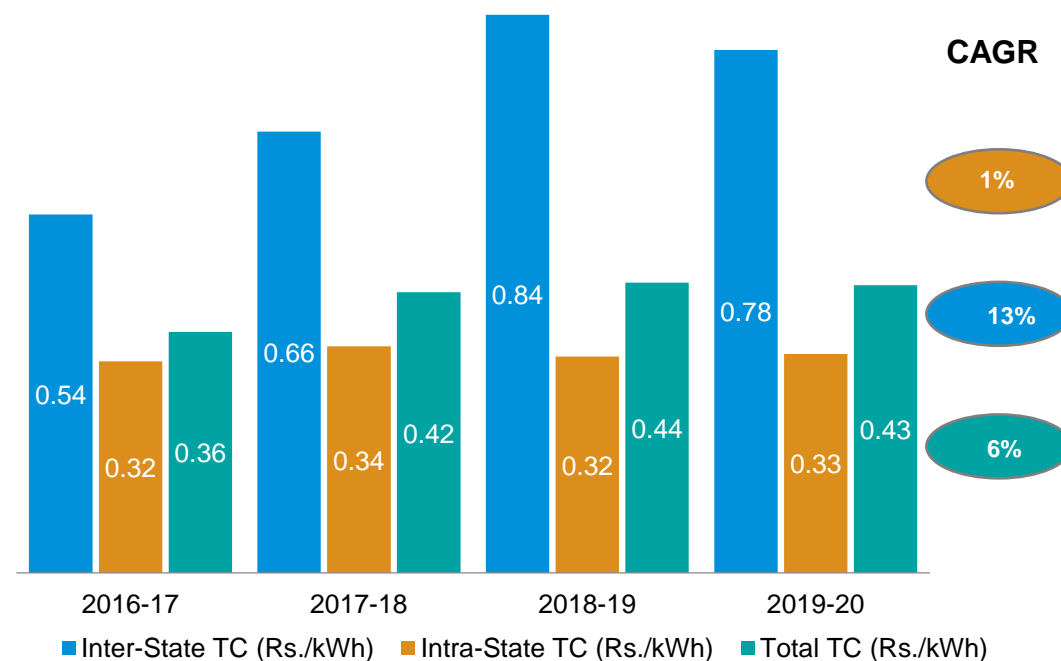

Per unit inter-state TC has increased over the last 4 years whereas per unit intra-state TC has increased marginally

Source: Tariff orders issued by respective state commissions for the last 4 years;

*Inter-state TC per unit is computed based on energy procured from ISGS and intra-state TC per unit is computed based on power procured from plants within the state

Transmission charges

Hypothesis: Regulated transmission tariff is higher than that discovered through competitive bidding

- ❑ Levelized cost discovered through competitive bidding for RECTPCL projects

Scheme Name	Tariff discovered through Competitive Bidding			Levelized Cost as per CERC (Rs. Crore)	Difference in levelized costs (in %)
	Project Cost (Rs. Crore)	Line Length (in km)	Levelized Cost of L1 Bidder (Rs. Crore)		
Transmission System (TS) Gadarwara STPS (2 x 800 MW) of NTPC (Part-B)	3,683	489	257	527	51%
TS Gadarwara STPS (2 x 800 MW) of NTPC (Part-A)	4,071	538	290	593	51%
TS Strengthening Vindhyachal-V	2,845	383	211	421	50%
Khargone TPP 1320MW	2,137	466	159	310	49%
Construction of Ajmer (PG)-Phagi 765 kV D/C line	872	132	61	118	48%
Construction of 765/400/220kV GIS Substation, Rampur and 400/220/132kV GIS Substation, Sambhal with Transmission Lines	1,094	72	103	187	45%

Tariffs being discovered through competitive bidding are significantly lower than the tariffs approved by the central regulator

Summary: Transmission charges

Hypothesis: Interstate transmission charges have increased over the last 4 years and during this period pan India market has also improved, enhancing reliability of grid operations (intangible benefits for all stakeholders)

- **Transmission infrastructure was developed based on demand projections**
- Inter-state transmission capacity was booked by state utilities based on anticipated demand
- Reduction in procurement from central sector plants as compared with capacity allocated has led to reduced utilization of inter-state transmission assets (short-term)
- ATC per unit power procured from central sector stations have increased significantly over the last 9 years
- Further, **tariff discovered through competitive bidding is significantly lower than regulated tariff**. SERCs may consider following competitive bidding route to reduce transmission costs and ACoS.
- As per the Tariff policy 2016, *“intra-state transmission projects shall be developed by State Government through competitive bidding process for projects costing above a threshold limit which shall be decided by the SERCs”*
- The state of Rajasthan has implemented competitive bidding process for transmission projects through RVPNL

Fixed Cost Elements



Return on Equity



ROE for generation, transmission and distribution companies

Hypothesis: Change in norms for estimation of ROE, may lead to significant reduction in electricity tariffs

Rate of RoE approved through various control periods by CERC

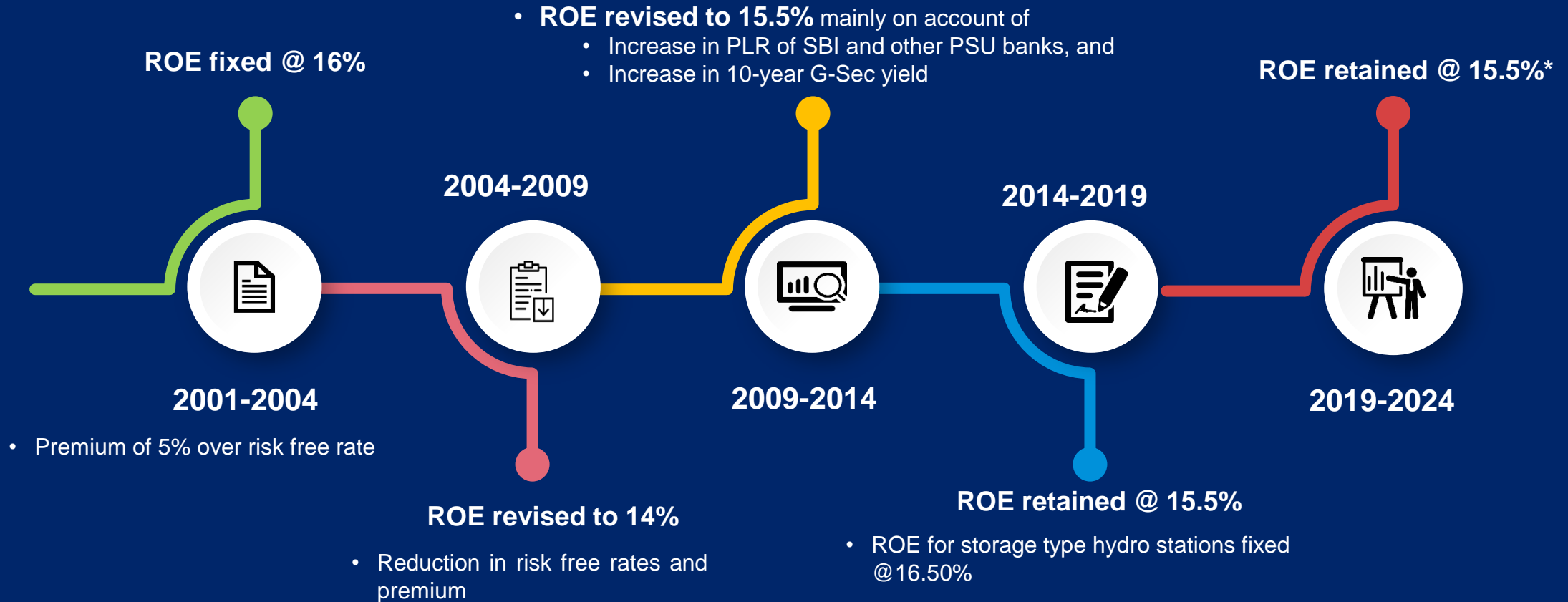

*Reduction in RoE by 1% given the station is declared under COD without commissioning of any of the RGMO or FGMO, data telemetry, communication system up to load dispatch center or protection system based on the report submitted by the respective RLDC.

ROE for generation, transmission and distribution companies

□ Rate of Return on equity in different states as per tariff regulations across the value chain

S. No.	States	State GENCO	TRANSCOs	DISCOMs
1	Odisha	16.0%	15.5%	16.0%
2	Maharashtra	15.5%	15.5%	15.5%
3	Uttar Pradesh	15.5%	14.5%	16.0%
4	MP	15.5%	15.5%	16.0%
5	Chhattisgarh	15.5%	15.5%	16.0%
6	Assam	15.5%	15.5%	16.0%
7	Himachal Pradesh	15.5%	15.5%	16.0%
8	West Bengal	15.5%	15.5%	15.5%
9	Uttarakhand	15.5%	15.5%	15.5%
10	Tripura	15.5% - 16.5%*	15.5%	15.5%
11	Punjab	15.5% - 16.5%*	15.5%	15.5%
12	Nagaland	15.5%	15.5%	15.5%
13	Manipur	15.5%	15.5%	15.5%
14	Mizoram	15.5%	15.5%	15.5%

S. No.	States	State GENCO	TRANSCO	DISCOM
15	Karnataka	15.5%	15.5%	15.5%
16	Jharkhand	14.0%	14.0%	14.5%
17	Jammu & Kashmir	15.5%	15.5%	15.5%
18	Bihar	15.5%	15.5%	15.5%
19	Andhra Pradesh	15.5%	14.0%	14.0%
20	Telangana	15.5%	14.0%	14.0%
21	Arunachal Pradesh	15.0%	14.0%	16.0%
22	Rajasthan	15.0%	14.0%	16.0%
23	Tamil Nadu	14.0%	14.0%	14.0%
24	Gujarat	14.0%	14.0%	14.0%
25	Haryana	14.0%	14.0%	14.0%
26	Kerala	14.0%	14.0%	14.0%
27	Delhi	14.0%	14.0%	16.0%
28	Sikkim	14.0%	14.0%	14.0%
29	Meghalaya	14.0%	14.0%	14.0%

Rate of ROE >15.50%	Rate of ROE equal to 15.50%	Rate of ROE <15.50%
---------------------	-----------------------------	---------------------

Several states have post-tax rate of return on equity lower than 15.50% as per tariff regulations

*For the state of Punjab and Tripura, it is mentioned in the tariff regulations that return on equity shall be computed at the rate of 15.50% and 16.50% for thermal power stations and storage type hydro generating stations, respectively.

*Source: Respective generation, transmission and distribution tariff regulations

Government securities (G-Sec) yield and prime lending rates

It can be observed that the primary lending rate and the G-Sec Rates have shown a declining trend over the years.

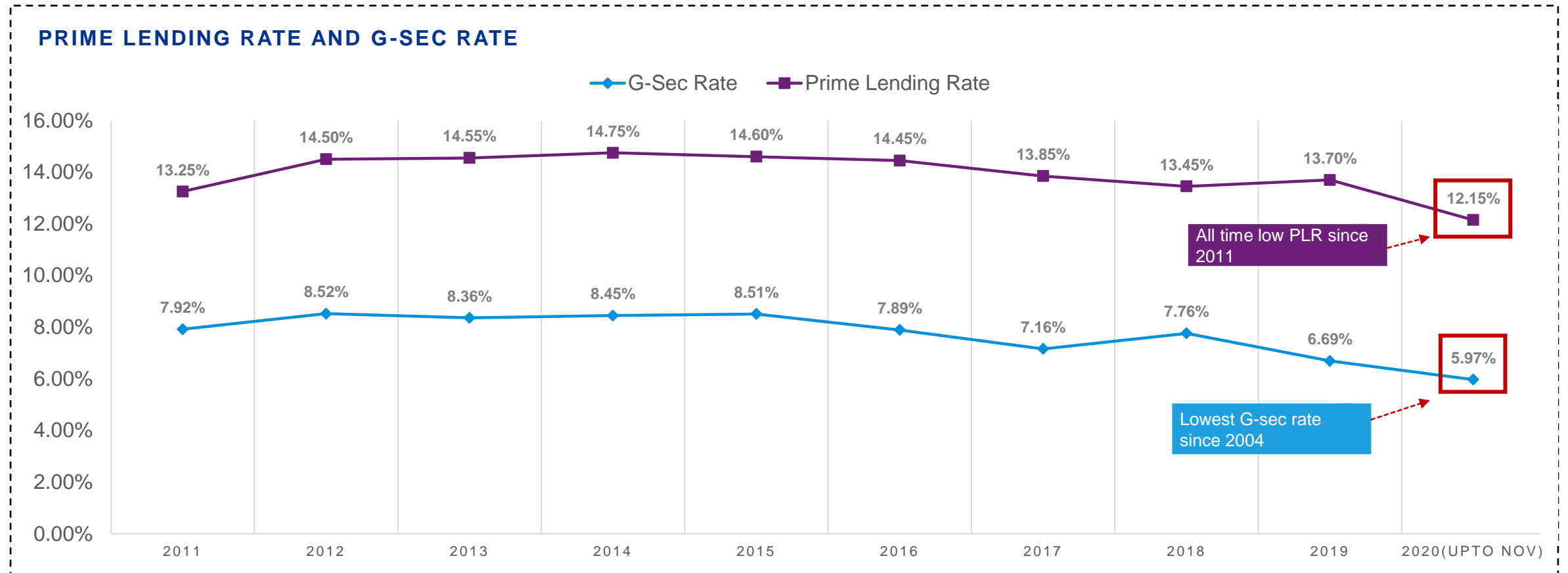

The rate of return on equity might be reviewed considering the present market expectations and risk perception of power sector for new projects

Approved ROE for 12 states in FY 2020-21

Contribution of ROE to the overall ARR

(All Figures in Rs. Cr. except wherever mentioned)

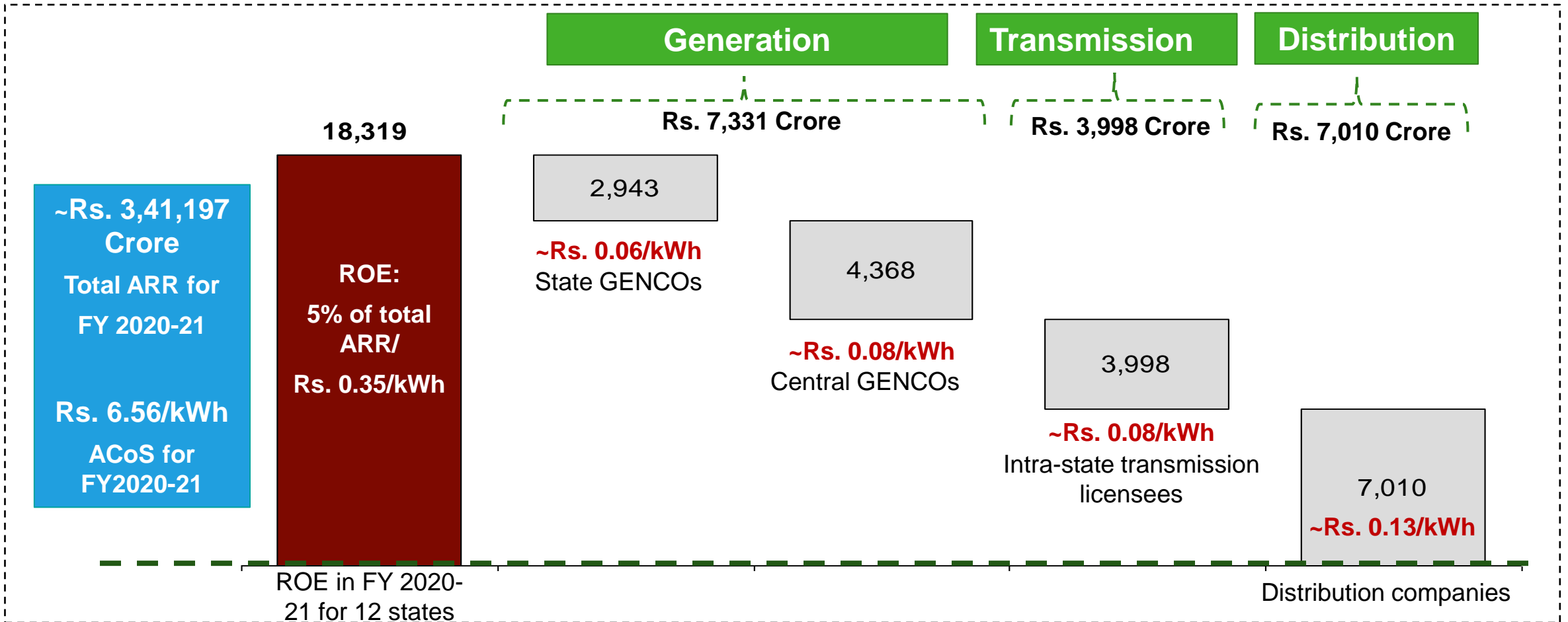

State-wise approved ROE for GENCO, TRANSCOs and DISCOMs for FY 2019-20

• RoE is computed for sample thermal power plants, data for some thermal power plants and Power Purchase breakup for states like AP & Odisha are not available in public domain; The above analysis does not include approved ROE for inter-state transmission licensee

*Source: Generation, transmission and distribution tariff orders issued for 12 states by respective commissions

Impact of change in the rate of ROE on ACoS

☐ For the tariff period 2019-24, the Commission has approved post tax base rate of 15.5%

Reduction in ACoS (in Rs./kWh) for 12 states at 14% and 12% rate of ROE during FY 2020-21

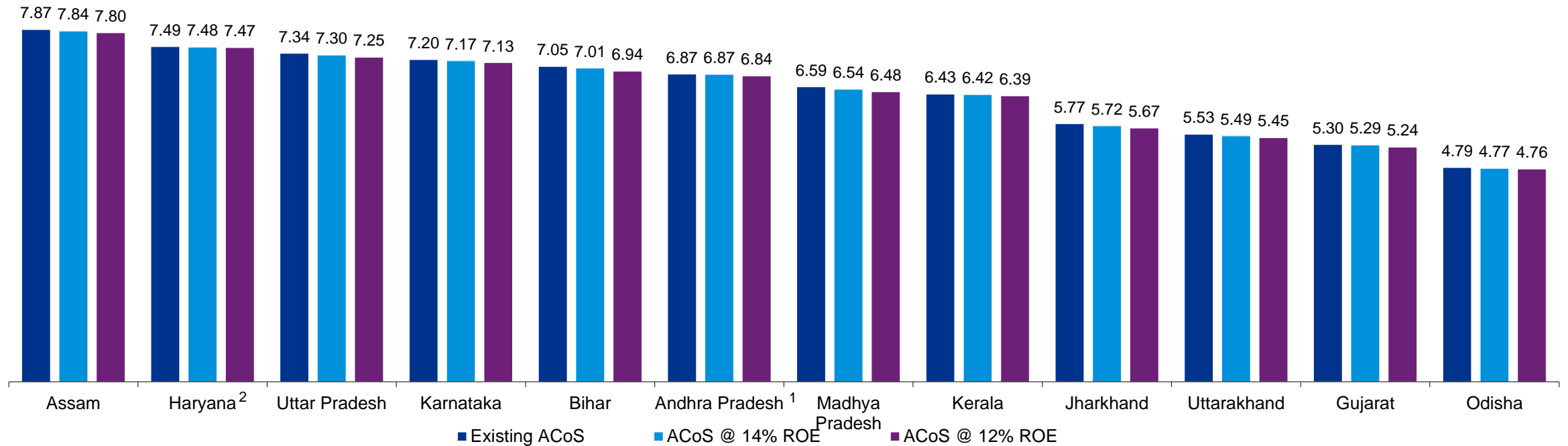

- Reduction of approved rate of ROE to **12%** would reduce ACoS by ~**Rs. 3,474 Crore/Rs. 0.07/kWh (1.0%)**
- Reduction of approved rate of ROE to **14%** would reduce ACoS by ~ **Rs. 1,230 Crore/ Rs. 0.02/kWh (0.4%)**

Reduction in ACoS is computed at 14%/12% rate of return or on actual rate whichever is lower; Reduction in ACoS has been rounded off to two decimal places

¹ For the state of Andhra Pradesh, the commission has approved 14% ROE for generation, transmission and distribution companies for 2020-21

² For the state of Haryana, the Commission has not allowed ROE for DISCOMs for 2020-21 due to the unprecedented situation emanating from the COVID-19 pandemic and the resulting restriction/lockdown ordered by Central Government/State Government

Impact of reduction in rate of RoE

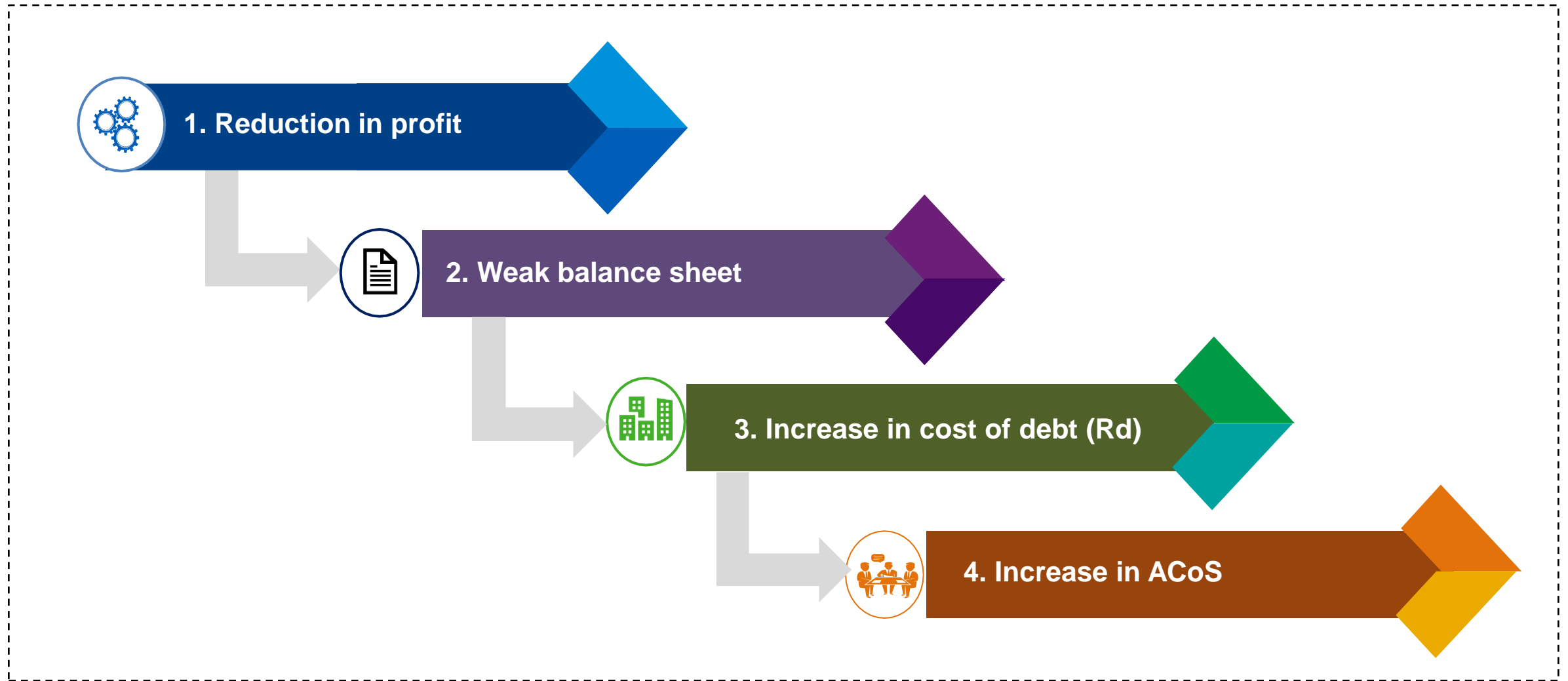

Tariff discovered through competitive bidding

S. No.	Company	Year	Lowest quoted tariff(Rs/kWh)	State	Tariff approved by state electricity regulatory commission(Rs/kWh)
1	SECI, 1070 MW Solar Auction	2020-21	2.00 ¹	Rajasthan	2.5 ² (for FY 2020)
2	GUVNL, Raghnesda Park 100 MW, Gujarat	2019-20	2.65 ³	Gujarat	5.34 ⁴ (for FY 2018)
3	SECI, Kadapa Solar Park (AP)	2018-19	2.70 ⁵	Andhra Pradesh	3.5 ⁶ (for FY 2019)
4	NTPC, Ananthapuram Solar Park 750 MW(AP)	2018-19	2.72 ⁷	Andhra Pradesh	3.5 ⁶ (for FY 2019)

Tariffs being discovered through competitive bidding are significantly lower than the tariffs approved by the central regulator

Source:

¹ <https://mercomindia.com/new-solar-tariff-record/>

³ <https://mercomindia.com/gujarat-tariff-2-65-solar-park/>

⁵ <https://mercomindia.com/solar-projects-andhra-pradesh-delays/>

⁷ <https://mercomindia.com/ntpc-750mw-solar-auction-results/>

² <https://rerc.rajasthan.gov.in/rerc-user-files/tariff-orders>

⁴ https://www.gercin.org/wp-content/uploads/2020/05/GERC-Solar-Tariff-Order-No.03-2020_08052020.pdf

⁶ <http://aperc.gov.in/admin/upload/PettiiionOP67of2019.pdf>

Depreciation cost



Depreciation cost

Hypothesis: Change in norms for estimation of depreciation, may lead to significant reduction in electricity tariffs

- ❑ The depreciation reserve is created to fully meet the debt service obligation and is a major component of the annual fixed cost across the value chain.

Regulatory Framework

- Straight Line Method (SLM) of depreciation has been used in all the previous four tariff periods.
- Useful lives of all types of generating stations and transmission systems except gas-based generating stations have remained same in all the tariff periods.

Other Provisions

- In 2001 and 2004 Tariff Regulations, the Commission had adopted the provision of Advance Against Depreciation (AAD) in order to ensure enough cash flows to meet loan repayment obligations
- However, the 2009 Tariff Regulations dispensed with the provision of AAD.
- The depreciation rate was worked out by considering normative repayment period of 12 years to repay the long-term loan (70% of the capital cost).

Approved depreciation cost for 12 states in FY 2020-21

Contribution of depreciation cost to the overall ARR

(All Figures in Rs. Cr. except wherever mentioned)

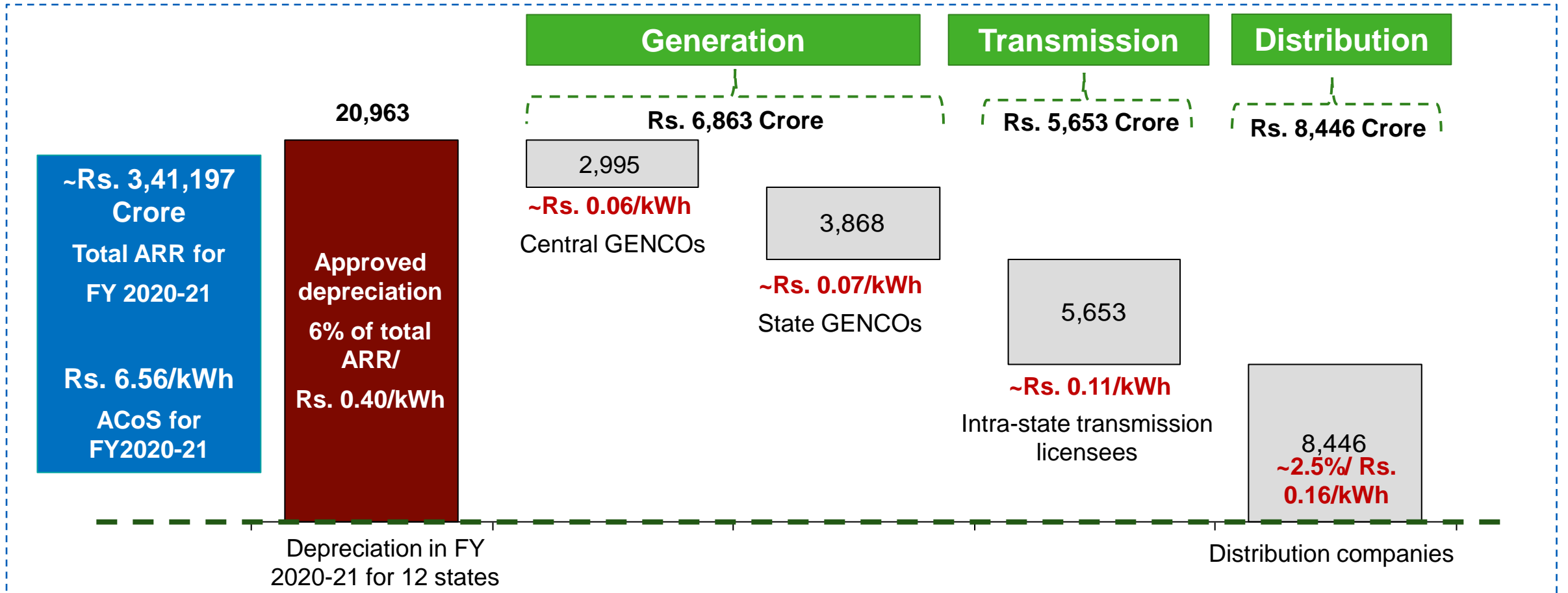

- Depreciation is computed for sample thermal power plants, data for some thermal power plants and Power Purchase breakup for states of AP & Odisha are not available in public domain. The above analysis does not include approved depreciation costs for inter-state transmission licensee

State-wise approved depreciation for GENCO, TRANSCOs and DISCOMs for FY 2019-20

*Source: Generation, transmission and distribution tariff orders issued for 12 states by respective commissions

Impact of change in the rate of depreciation on ACoS

- ❑ As per the prevailing norms, depreciation rate is estimated by considering loan repayment period of 12 years to repay the loan (70% of the capital cost)
- ❑ Reduction of depreciation rate to 4.67% (considering loan repayment period of 15 years to repay 70% of the capital cost) would reduce ACoS by **~Rs. 3,500-4,000 Crore/ Rs. 0.08kWh (1.2%)**
- ❑ Reduction of depreciation rate to 4.34% (considering loan repayment period of 15 years to repay 65% of the capital cost) would reduce ACoS by **~Rs. 4,500-4,800 Crore/ Rs. 0.10kWh (1.4%)**

Depreciation norms: Petroleum sector

Petroleum and Natural Gas Regulatory Board (PGRB)

- Determines the transportation tariff for (a) Petroleum and Petroleum Products pipelines and (b) Natural Gas pipelines (awarded on nomination basis)

Tariff determination for transportation of →	Petroleum and Petroleum Products	Natural Gas
Regulation	Determination of Petroleum and Petroleum Products Pipeline Transportation Tariff) Regulations, 2010	Determination of Natural Gas Pipeline Tariff Regulations, 2008
Procedure for Tariff determination	Benchmarking against rail tariff at a level of 75% (100% for LPG) on a train load basis for equivalent rail distance along the petroleum and petroleum product pipeline route.	Cost plus basis
Treatment of Depreciation	Not Applicable	<ul style="list-style-type: none"> ▪ Rate of Depreciation: Depreciation on fixed assets on straight line basis based on rates as per Schedule VI to the Companies Act, 1956)
Regulation	Determination of Petroleum and Petroleum Products Pipeline Transportation Tariff) Regulations, 2010	Determination of Natural Gas Pipeline Tariff Regulations, 2008

Depreciation rationalization – Case study of Uttar Pradesh

Fixed Asset Register (FAR)

- The main objective of FAR is to hold accurate information about each asset. So that asset can be utilized when it is required. Moreover, this register also assists in tracking the asset value and depreciation value also.

- Typically, FAR is not maintained because of which it is not possible to carry out the prudence check that the depreciation on any asset is not claimed beyond permissible limit of 90% of cost of Asset



- The Transmission and Distribution Licensees to be directed to maintain proper and updated Fixed Asset Registers.
- In case, proper FAR is not maintained certain component of depreciation may be dis-allowed or withheld.

Depreciation rationalization – Case study of Uttar Pradesh

Uttar Pradesh Electricity Regulatory Commission

- UPERC in their Tariff orders for FY 2012-13 mentioned that ***“Components of the ARR viz., depreciation, allowable interest on debt and return on equity are adversely affected by inadvertent misrepresentations of capital assets creation numbers.”***
- In the same tariff order UPERC further submitted that ***“...the Commission is severely hindered in its task of undertaking prudence check of ARR components viz., depreciation, and allowable interest on debt and return on equity. On account of lack of details of fixed assets register, the Commission has assessed depreciation based on wt. avg. depreciation rates...”***
- In FY 2013-14, UPERC ***withheld 20%*** of the allowable depreciation and mentioned that same may be allowed upon submission of FAR.
- Further, 25% depreciation of FY 2014-15, 30% in FY 2015-16 & FY 2016-17 ***was withheld due to non submission of FAR***
- During the True-up for FY 2014-15 the DISCOMs submitted the FAR up to FY 2014-15 on June 21st, 2017.
- The commission noted, that there was a delay in submission of FAR (submitted on August'16 instead of November' 13 as directed by UPERC). Consequently the UPERC withheld the 20% of the allowable depreciation for FY 2013-14.
- During True-up of FY 2014-15, FY 2015-16 and FY 2016-17 the commission has allowed the withheld 25% depreciation, as the DISCOMs has submitted the FAR at the time of true-up

Analysis of internal factors



Approved distribution losses

Hypothesis: Change in approved distribution losses may lead to significant reduction in electricity tariffs

Distribution loss*

Approved distribution loss (%) for licensees of 12 states for FY 2020-21 and impact on ACoS

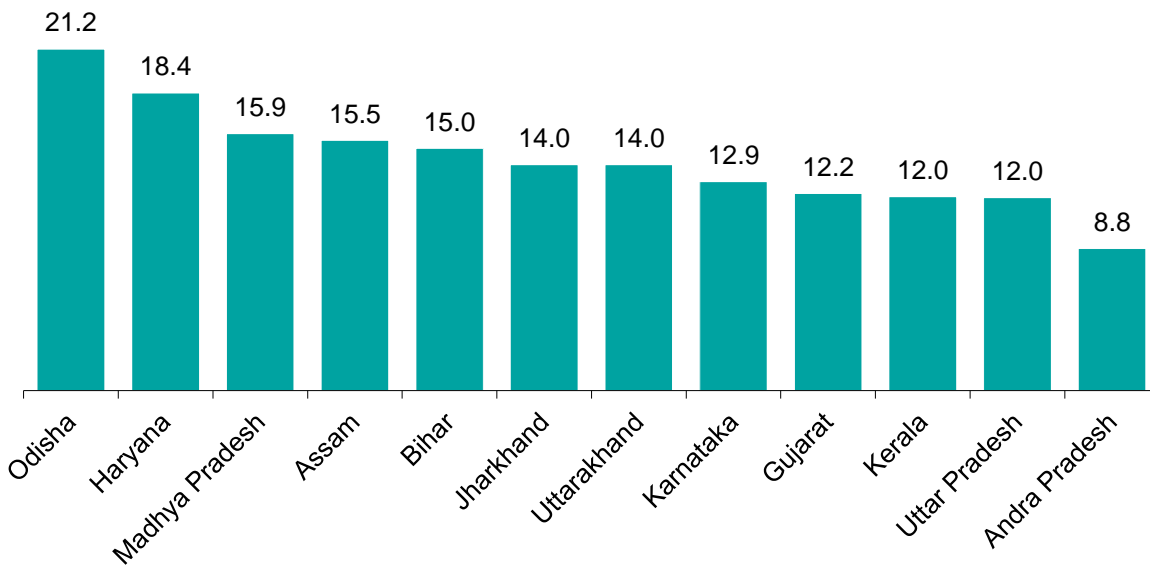

Reduction in ACoS (Rs/kWh) on account of change in rate of distribution loss

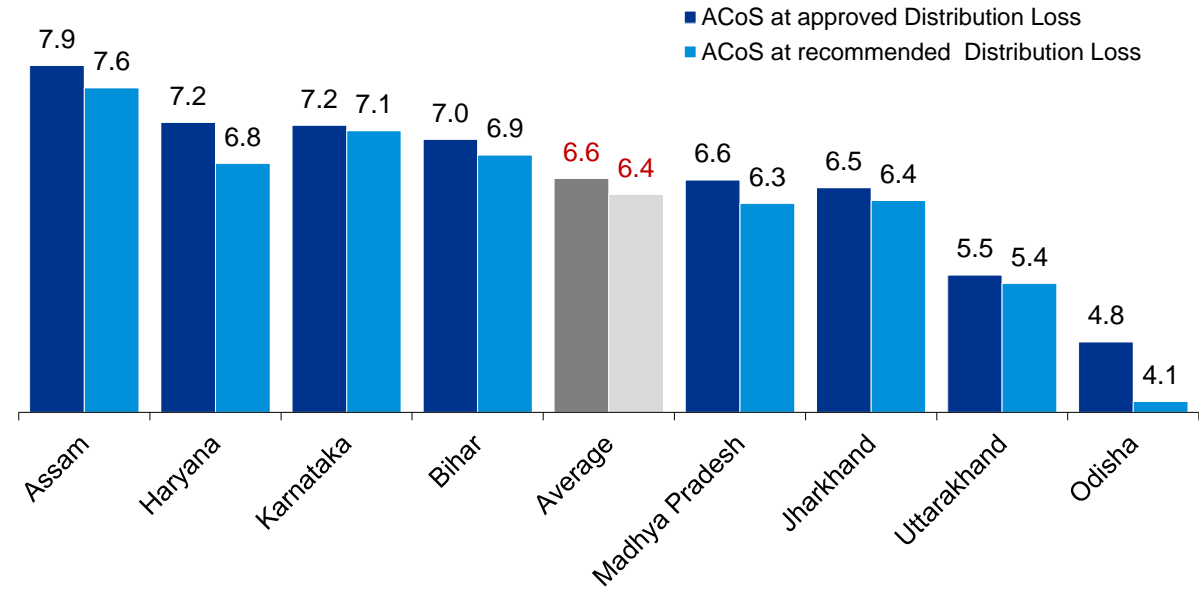

- The approved distribution losses for 12 states for FY 2020-21 varied in the range 12-18% (excluding Andhra Pradesh- ~9% and Odisha- ~21%)

- Reduction of approved rate of Distribution losses to 12% would reduce ACoS by **Rs. 0-0.66 /kWh/ (3%)**

*Distribution loss does not include inter-state and intra-state transmission losses

Approved Distribution Loss rates for Distribution Utilities

Hypothesis: Change in approved distribution losses may lead to significant reduction in electricity tariffs

Distribution Loss

Contribution of distribution losses (in Rs./kWh) to ACoS for FY 2020-21

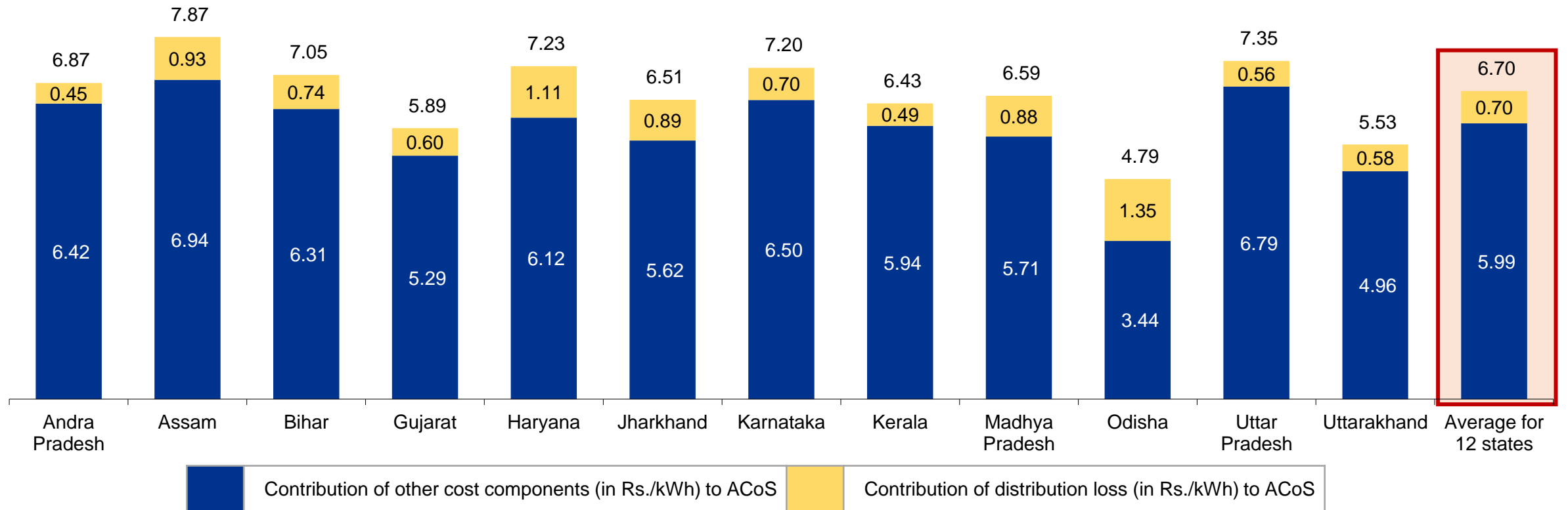

Distribution losses contributed about 8% to 21% to ACoS for 12 states for FY 2020-21

*Source: Distribution tariff orders issued for 12 states by respective commissions

O&M Expenses for distribution companies

O&M Charges

Approved O&M Expense for licensees of 12 states for FY 2020-21*

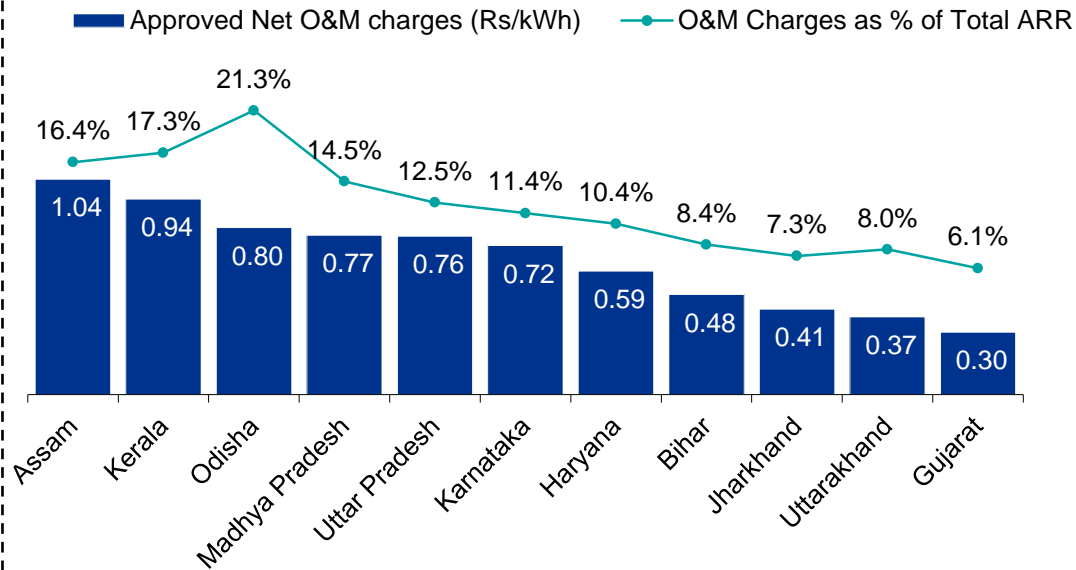

- Norms for approval of O&M expenses are based on historical cost performance of individual metrics such as total expense on lines per unit of line length created.

Expenditure on O&M (Rs) per 1000 units of energy handled by DISCOMs#

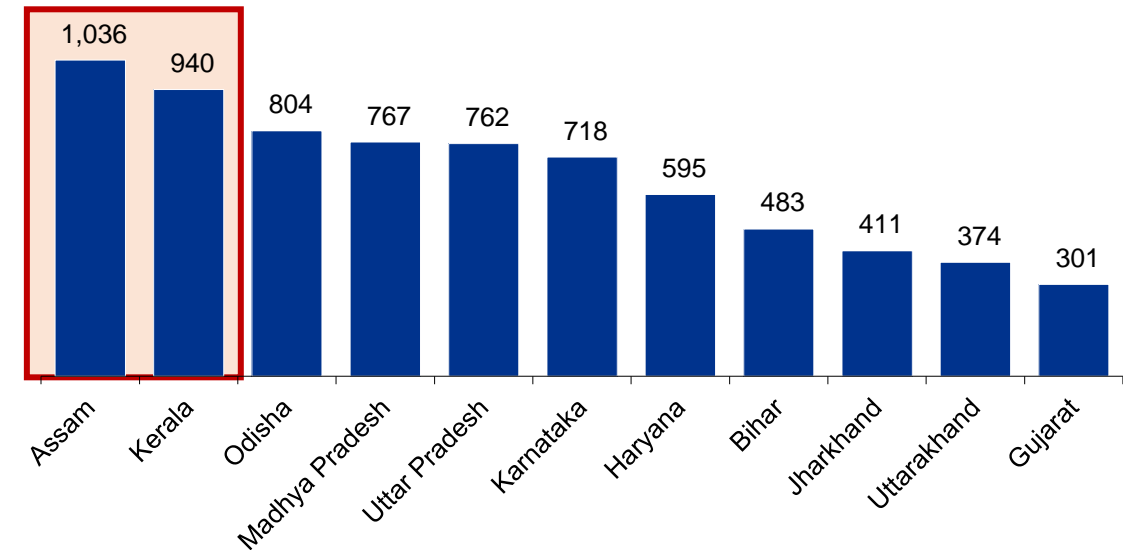

- Initiatives and field level best practices undertaken by better performing states (Gujarat, Uttarakhand, etc.) might be disseminated across states for reduction in O&M costs

#Expenditure on O&M shows a wide range of variation from Rs. 301 (Gujarat) to Rs 1,036 (Assam) per 1000 units of energy handled. This is mainly on account of variation in factors such as Number of Consumers, Network length and expanse, HT/LT ratio and age of infrastructure .

*Latest available TO is used for states wherein FY21 TO is not available

*Source: Distribution tariff orders issued for 12 states by respective commissions

O&M Expenses for state and central GENCOs

O&M Charges

Approved O&M Expense for generation licensees of 12 states for FY 2018-19*

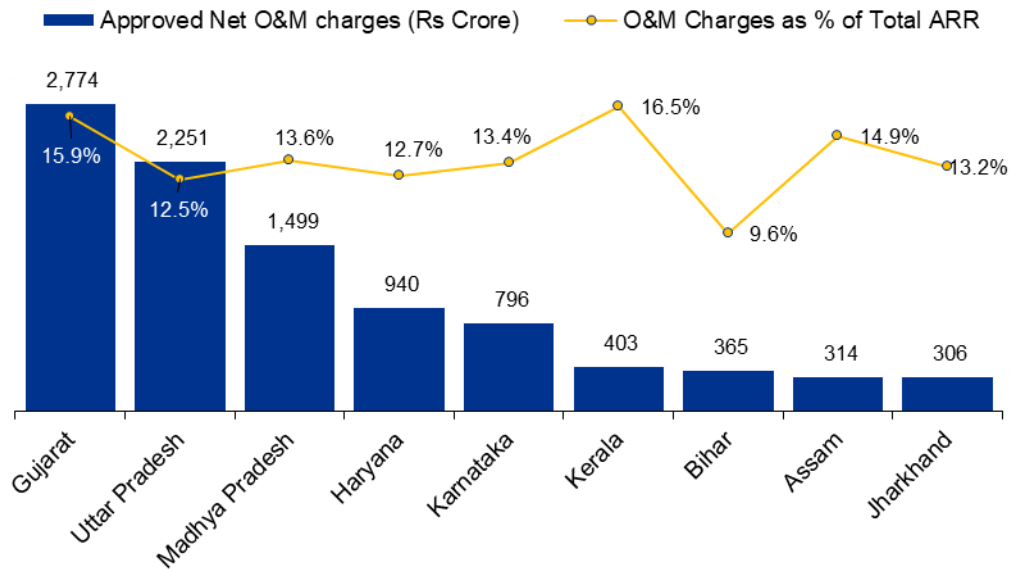

- Approved O&M expenses varied in the range of 10-16% of the total ARR of central and state GENCOs for the 12 states

Expenditure on O&M (Rs) per 1000 units of energy handled by DISCOMs

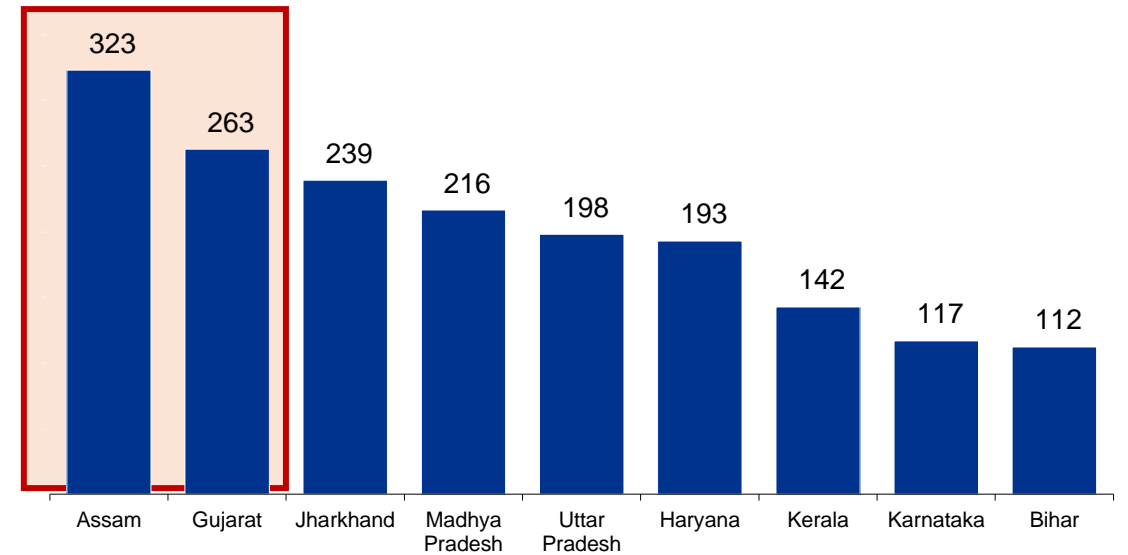

- Initiatives and field level best practices undertaken by better performing states (Karnataka, Bihar, etc.) might be disseminated across states for reduction in O&M costs

Source: Generation tariff orders issued for 12 states by respective commissions

*Latest available TO is used for state and central GENCOs

Interest & finance charges

Interest charges

Approved I&F charges for licensees of 12 states for FY 2020-21*

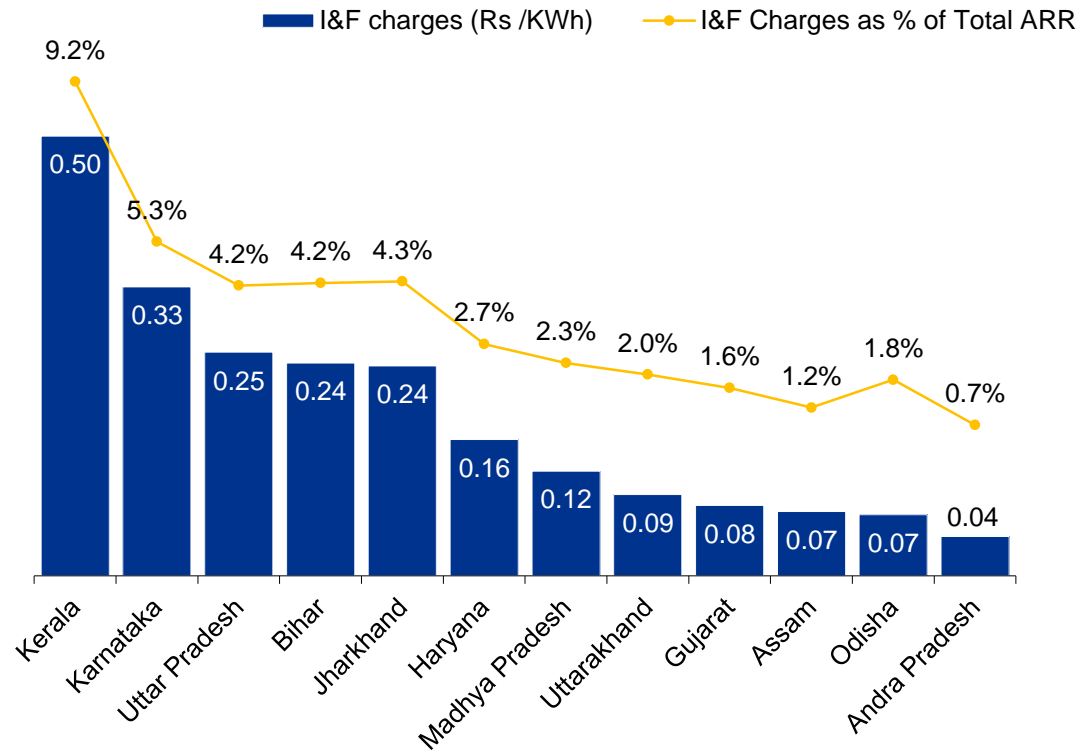

Expenditure on I&F per 1000 units of energy handled by DISCOMs

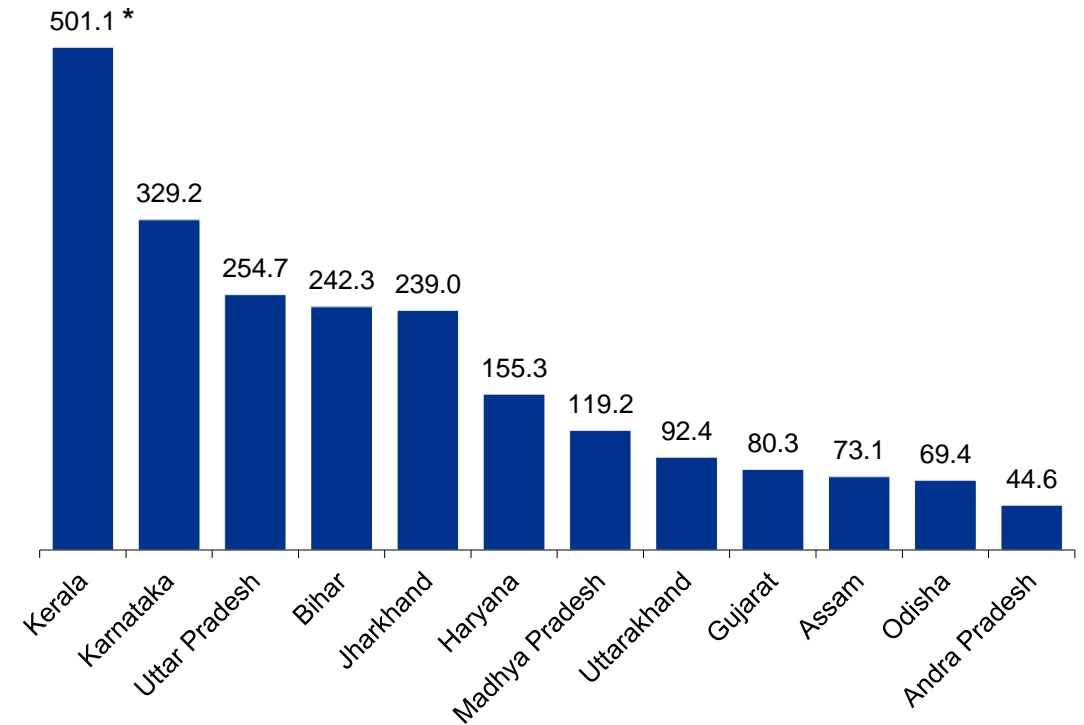

*Interest expense of KSEB includes expenses for Generation, Transmission and Distribution entities

*Source: Distribution tariff orders issued for 12 states by respective commissions

Other factors



Impact of retiring old coal based TPPs & impact of under-utilization of generating stations



Old TPPs: More than 30 years old

Hypothesis: Retiring of old power plants may lead to significant reduction in electricity tariff

❑ List of TPPs more than 30 Years Old, as on 31.03.2020 (1/2)

Sl. No.	State	Sector	Owner	Name of Project	Prime Mover	Unit No.	Total Units	Installed Capacity (MW)	Year of Comm.
1	UP	State Sector	UPRVUNL	ANPARA TPS	Steam	1 to 3	3	630	1986 to 1989
2	UP	State Sector	UPRVUNL	HARDUAGANJ TPS	Steam	7	1	105	1978
3	UP	State Sector	UPRVUNL	OBRA TPS	Steam	7	1	94	1974
4	UP	State Sector	UPRVUNL	OBRA TPS	Steam	9 to 13	5	1000	1977 to 1982
5	UP	State Sector	UPRVUNL	PARICHHA TPS	Steam	1 & 2	2	220	1984, 1985
6	UP	Central Sector	NTPC	RIHAND STPS	Steam	1 & 2	2	1000	1988, 1989
7	UP	Central Sector	NTPC	SINGRAULI STPS	Steam	1 to 7	7	2000	1982 to 1987
8	UP	Central Sector	NTPC	TANDA TPS	Steam	1 to 3	3	330	1988 to 1990
9	UP	Central Sector	NTPC	UNCHA HAR TPS	Steam	1 & 2	2	420	1988, 1989
10	UP	Central Sector	NTPC	AURAIYA CCPP	GT-Gas	1 to 6	6	663.36	1989, 1990
11	Gujarat	State Sector	GSECL	UKAI TPS	Steam	3 to 5	3	610	1979, 1985
12	Gujarat	State Sector	GSECL	WANAKBORI TPS	Steam	1 to 6	6	1260	1982 to 1987
13	Gujarat	Private Sector	Torrent Power Ltd	SABARMATI (D-F STATIONS)	Steam	1 to 3	3	360	1978 to 1988

Old TPPs: More than 30 years old

Hypothesis: Retiring of Old Power Plants may lead to significant reduction in Electricity Tariff

❑ List of TPPs more than 30 Years Old, as on 31.03.2020 (2/2)

Sl. No.	State	Sector	Owner	Name of Project	Prime Mover	Unit No.	Total Units	Installed Capacity (MW)	Year of Comm.
14	MP	State Sector	MPPGCL	SATPURA TPS	Steam	6 to 9	4	800	1979 to 1984
15	MP	Central Sector	NTPC	VINDHYACHAL STPS	Steam	1 to 5	5	1050	1987 to 1990
16	AP	State Sector	APGENCO	Dr. N.TATA RAO TPS	Steam	1 to 4	4	840	1979 to 1990
17	Karnataka	State Sector	KPCL	RAICHUR TPS	Steam	1 & 2	2	420	1985, 1986
18	Bihar	Central Sector	NTPC	BARAUNI TPS	Steam	6 & 7	2	210	1983
19	Bihar	Central Sector	KBUNL	MUZAFFARPUR TPS	Steam	1 & 2	2	220	1985
20	Odisha	Central Sector	NTPC	TALCHER (OLD) TPS	Steam	1 to 6	6	460	1967 to 1983
21	Assam	State Sector	APGCL	NAMRUP CCPP	GT-Gas	2 to 6, 8	6	99	1965 to 1985
Thermal Plants for 12 states selected for Study > 30 Years Old								12,791	

Installed Capacity (MW)		
Total All India Thermal + Hydro + Nuclear (MW) AS ON 31.03.2020	283,078	100%
Total All India Thermal (MW) AS ON 31.03.2020	230,600	81%
All India Thermal Plants > 30 Years Old (MW)	27,334	12%
Thermal Plants for 12 states selected for Study > 30 Years Old (MW)	12,791	6%

Impact of retiring old coal based TPPs: Andhra Pradesh

Hypothesis: Retiring of old power plants may lead to significant reduction in electricity tariff

- Detailed analysis of key parameters (as per norms) of old vs. latest coal based Thermal Power Plants

State	Sector	Owner	Name of Project	Prime Mover	Unit No.	Total Units	Installed Capacity (MW)	Year of Comm.
Andhra Pradesh	State Sector	APGENCO	Dr. N.TATA RAO TPS	Steam	1 to 4	4	840	1979 to 1990

Dr. N.TATA RAO TPS - Particulars	Unit	Actual Norms, as per TO	Norms, as per TO applicable for Latest Generating Station
Installed Capacity	MW	840	840
Plant Load Factor (%)	%	80%	80%
Gross Generation	MU	5886.72	5886.72
Auxiliary Consumption	%	9.00%	8.50%
Net Generation	MU	5,356.92	5,386.35
Station Heat Rate	kCal/kWh	2550	2430
Secondary Fuel Oil Consumption	ml/kWh	NA	NA
Price of oil	Rs./kL	NA	NA
Price of coal	Rs./MT	3,450.00	3,450.00
Energy Charge Rate (Ex-bus)	Rs./kWh	2.92	2.77
Reduction in Energy Charge Rate @ (Ex-bus)			5%

- There is a reduction of about 5% in the Energy Charges, in case the norms for latest thermal generating station is applied to old thermal generating station which is more than 30 years old.
- There is an Old Coal based TPPs having capacity of 840 MW, the same can be discontinued as there is an energy surplus of ~ 7,800 MU or ~ 890 MW, which leads to significant reduction in Electricity Tariff.

Energy Availability & Requirement						
State	FY	Energy Availability (MU)	Energy Requirement (MU)	Energy Surplus (MU)	Surplus in MW	Old Coal based TPPs (>30 Years Old), MW
AP	2018-19	68,672	60,843	7,829	893.72	840

Analysis for the states of GJ, MP, Bihar, Odisha and UP

Impact of under-utilization of generating stations



Impact of under-utilization of generating stations

Hypothesis: Optimal utilization of TPPs may lead to reduction in electricity tariffs

Reason for under-utilization of generating station

1 Shortage of coal

3

Not following Merit Order Dispatch properly

2 Generating plants running on technical minimum due to higher energy availability.

4

Targets set by Ministry of Power for RE procurement

Issue of coal shortage and technical minimum can be handled by retiring old coal based TPP as discussed in previous section. States like Madhya Pradesh, Gujarat, Andhra Pradesh etc. are surplus states.

Recently, MERC has issued guidelines for operation of Merit Order Dispatch under availability-based tariff order. Other states can examine the same in their state as per their Energy Gap scenario. Detailed regarding the guidelines issued by MERC are provided in subsequent slides. Proper implementation of MOD can improve the utilization of Generating Station.

Procurement of Renewable Energy is one of the reason for under-utilization of Generating Stations.

Maharashtra: Merit Order Dispatch (MOD) guidelines

Maharashtra Electricity Regulatory Commission (MERC) issued guidelines for operation of Merit Order Dispatch (MOD) under availability-based tariff order. These guidelines came into effect from the month of April 2019.

The following key aspects have been identified and addressed in the guidelines:

Guidelines for Reserve Shut Down (RSD) instructions to the Generating Units.

Guidelines for Zero Schedule instructions to the Generating Units.

Other aspects:

- Periodicity and date of preparation of MOD stack.
- Basis of preparation of MOD stack, including the variable charge to be considered
- Guidelines for operating the Generating Units.
- Guidelines for capacity declaration by Generating units
- Identification of Must Run Stations, and guidelines for operating Hydro Stations
- Technical Minimum of Generating Units.

[Detailed Guidelines](#)

Installed Capacity, Peak Demand and Stranded Capacity



Installed Capacity & Peak Demand (GW)

Comparison of Region Wise Installed Capacity and Peak Demand (FY 2018-19)

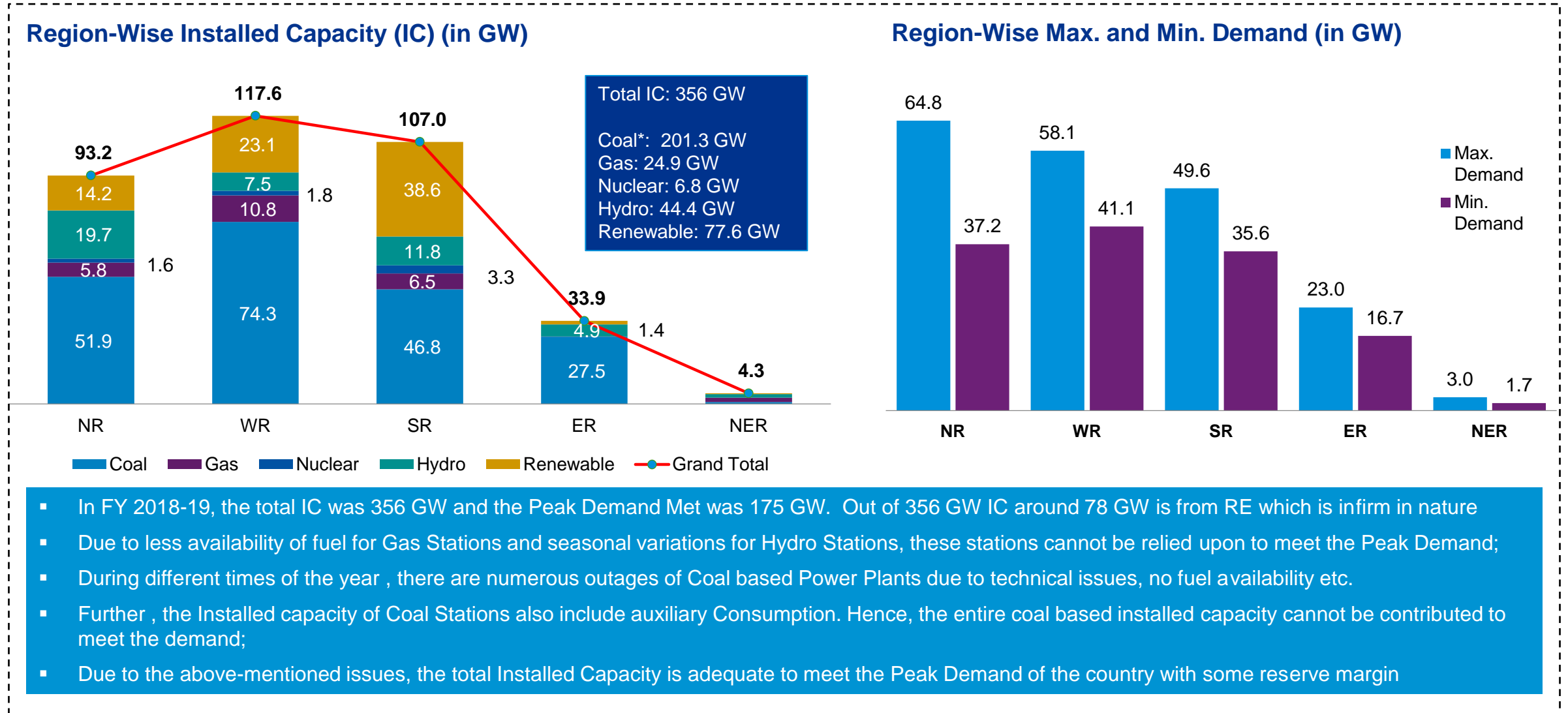

* Coal including Lignite and Diesel

Installed Capacity & Peak Demand (MW)

Comparison of Region Wise Installed Capacity and Peak Demand (FY 2019-20)

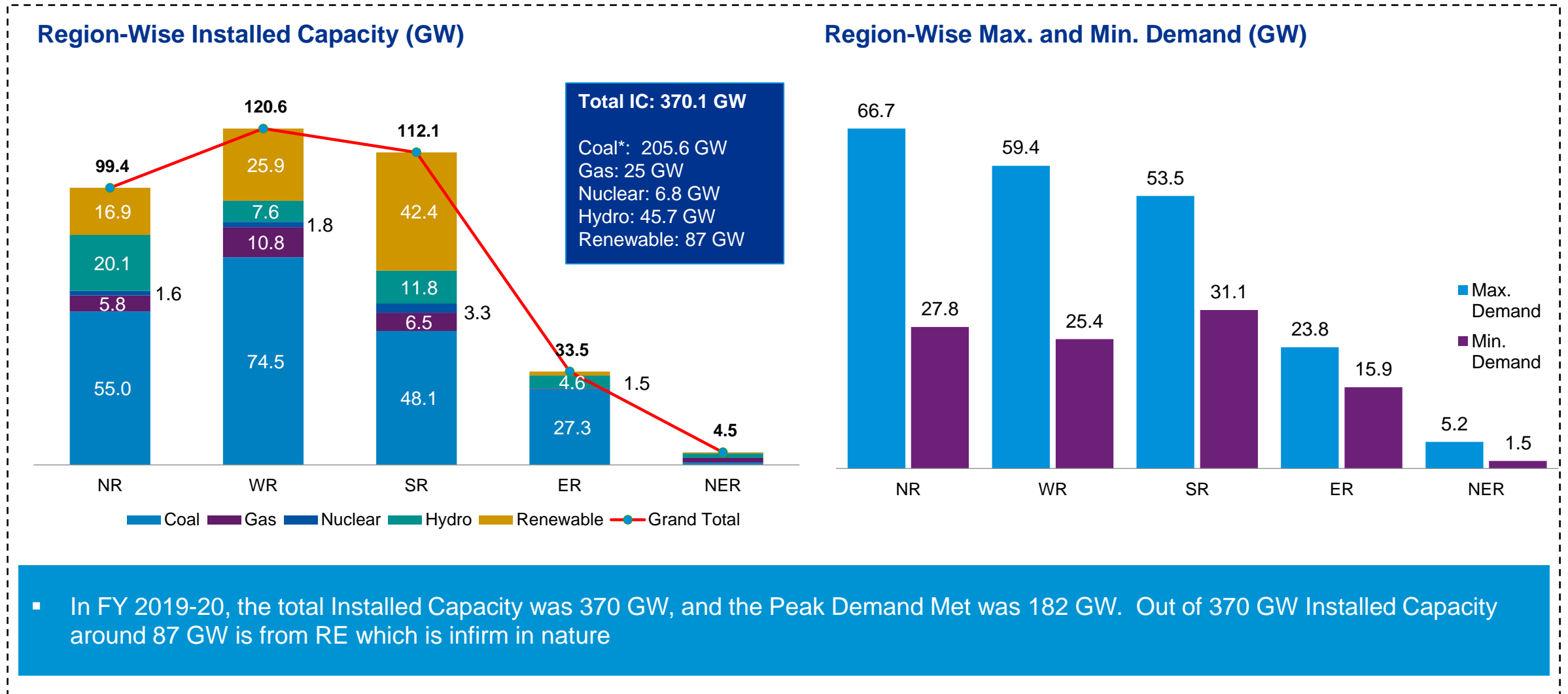

* Coal including Lignite and Diesel

Compliance of new environmental norms



Benchmarking of capital cost for FGD-capital cost specified by CEA

- In the Notification dated 7 December, 2015, CEA has specified an indicative capex cost in Rs. lakh/MW for FGD installation for various unit sizes and it is discovered through open competitive bidding for the projects already awarded
- This capex is “Base Cost” only with cost of new chimney and does not include Taxes-Duties and IDC
- CEA has specified that the Base Cost may further vary as per the following conditions:
 - Increase in no. of Units will reduce the capex because of common facilities.
 - Range of SO₂ removal
 - Chimney Layout such as using existing chimney as wet stack, new wet stack with single or multi flue cans, Chimney above absorber, provision of temporary chimney for making existing chimney operational and chimney material
 - Choice of Corrosion protection lining in chimney, absorber and other sections of FGD.
- Also, the cost may further come down in future due to increased number of vendors/suppliers as the market matures.

FGD Base Cost specified by CEA

Capacity Group (MW)	CAPEX (Rs. Lakh/MW)
210	45
250	
300	43.5
500	40.5
525	
600	37
660	
800	30
830	

Benchmarking of capital cost for FGD- capital cost considered by CERC/SERCs

- For benchmarking of FGD cost, the cost estimates projected by the other generating stations for installing FGD system may be referred as shown in the Table
- CERC has considered the Capital Cost range of Rs. 43 to 75 lakh/MW for various Central generating stations**
- MERC has considered the Capital Cost of Rs. 65 lakh/MW for Tiroda TPS
- UPERC has considered the Capital Cost of Rs. 1.29 Crore/MW for Rosa plant

Cost specified by CSE

- The Centre of Science and Environment (CSE), New Delhi, in its publication on the conference titled 'New Environmental Norms: The Way Forward' held on 7 September, 2016 cited the cost of FGD as Rs. 50 to 60 lakh/MW.

Total Cost including Taxes and IDC

Sr. No.	Name of Generating Station	Installed Capacity	Estimated Cost		Reference
1	Vindhyachal Super Thermal Power Station Stage V	500 MW	Rs. 201.30 Crore	Rs. 0.40 Crore/MW	CERC Order dated 31.08.2016 in Petition No. 234/GT/2015
2	Rosa Power Supply Company Ltd.	1200 MW	Rs. 1550.50 Crore	Rs. 1.29 Crore/MW	UPERC Order dated 25.05.2017 in Petition No. 1132 of 2016
3	Maithon Power Ltd.	1050 MW	Rs. 777.14 Crore	Rs. 0.74 Crore/MW	CERC Order dated 11.11.2019 in Petition No. 152/MP/2019
4	Bongaigaon Thermal Power Station Unit 1	250 MW	Rs. 108 Crore	Rs. 0.43 Crore/MW	CERC Order dated 22.05.2017 in Petition No. 45/GT/2016
5	Udupi Thermal Power Station	1200 MW	Rs.899 Crore	Rs. 0.75 Crore/MW	CERC Order dated 20.11.2019 in Petition No. 346/MP/2018
6	Adani Power Maharashtra Ltd-Tiroda TPS	3300 MW	Rs. 2159 Crore	Rs. 0.65 Crore/MW	MERC Order dated 06.02.2019 in Case No. 300 of 2018
7.	Sasan Power Limited	3960 MW	Rs. 2434 Crore	Rs. 0.615 Crore/ MW	CERC Order dated 23.04.2020 in Petition No. 446/MP/2019

Total Cost in range of Rs 40-75 lakh/MW may be considered for evaluating DPRs by SERCs

CERC staff paper on FGD

Impact of Additional Capital Expenditure (ACE-ECS)

- Additional capital expenditure include **base cost of Emission Control Systems (ECS), taxes and duties, IDC and miscellaneous costs associated with installation of ECS.**
- Increase in monthly tariff spread over useful life of the ECS through Supplementary Capacity Charges (SCC) which includes:
 - a) Depreciation (ACEDep)
 - Life of 25 years 90% (considering salvage value of 10%) of additional capital expenditure on account of installation of ECS is proposed to be recovered by the generating company in 25 years as depreciation {straight line method @3.6% (90%/25) per year} starting from date of operation of ECS.
 - b) Cost of Capital Employed for ECS (ACEcoc)
 - Additional capital expenditure on installation of emission control system is proposed to be serviced on Net Fixed Assets (NFA) basis (value of fixed assets reducing each year by the depreciation value) @ weighted average rate of interest of loans raised by the generator or at the rate of Marginal Cost of Lending Rate of State Bank of India (for one-year tenure) plus 350 basis points, as on 1st April of the year in which emission control system is put into operation, whichever is lower.

Note: Where the technology is installed with “Gas to Gas” heater, AUX specified above shall be increased by 0.3% of gross generation

CERC staff paper on FGD

Norms for O&M expenses & working capital

Additional O&M Expenses

- First year O&M expenses @2% of capital expenditure for installation of FGD (excluding IDC and FERV) admitted by the Commission after prudence check.
- For subsequent years, the first year O&M expenses may be escalated @3.5% or any other escalation rate as may be specified by the Commission

Additional Working Capital

- Working Capital may include:
 - i) Cost of limestone or reagent towards stock for 20 days corresponding to the normative annual plant availability factor and advance payment for 30 days towards cost of reagent for generation corresponding to the normative annual plant availability factor;
 - ii) Operation and maintenance expenses in respect of emission control system for one month and maintenance spares @20% of operation and maintenance expenses in respect of emission control system; and
 - iii) Receivables equivalent to 45 days of supplementary capacity charge and supplementary energy charge for sale of electricity calculated on the normative annual plant availability factor.

CERC staff paper on FGD

Auxiliary consumption

Auxiliary consumption

Name of Technology	AUX (as % of Gross Generation)
a) Wet Limestone based FGD system (without Gas to Gas heater)	1.0%
b) Lime Spray Dryer or Semi dry FGD System	1.0%
c) Dry Sorbent Injection System (using Sodium bicarbonate)	NIL
d) For CFBC Power plant (furnace injection)	NIL
e) Sea water based FGD system (without Gas to Gas heater)	0.7%

Note: Where the technology is installed with “Gas to Gas” heater, AUX specified above shall be increased by 0.3% of gross generation

Estimated impact on tariff

- Impact on tariff on account of Wet Limestone based FGD has been computed for a sample 3*500 MW of Thermal Power Project
- For impact of tariff, capital cost of Rs. 800.23 Crore (Rs 0.53 Lakh/MW) has been considered based on CEA specified base cost of Rs. 40.5 Lakh/MW for 500 MW Unit size and additional cost of Taxes-Duties and IDC
- Operation of plant has been considered for 25 years
- The total per unit Levelized Tariff Impact for 25 years works out to be around Rs. 0.247/kWh**

Impact on Tariff (Rs./kWh)

S. No.	Tariff Component	Levelized Tariff for 25 years (Rs./kWh)
1	<i>Differential energy charge (for additional Aux. cons. due to FGD)</i>	0.034
2	<i>Limestone cost</i>	0.098
A	Variable cost	0.132
3	<i>O&M cost</i>	0.015
4	<i>Interest on debt</i>	0.034
5	<i>Depreciation</i>	0.035
6	<i>Return on equity</i>	0.027
7	<i>IoWC</i>	0.004
B	Fixed cost	0.115
C	Total Impact on Tariff (A+B)	0.247

Tentative levelized Tariff Impact of around 20-30 paise/kWh may be considered by SERCs for evaluating DPRs

Phasing of FGD as per CEA concept paper

- CEA, in its Paper on “Plant Location Specific Emission Standards” has observed that there should be **graded action plan for adopting new emission norms for TPS** rather than adopting a single deadline for large base of power plants across the country
- CEA recommended that Phasing of FGD Installation should be done based on **Ambient Air Quality (AAQ) and SO₂ Levels** in that location
- CEA proposed to implement FGD for the thermal power plants region-wise as given in the table:
 - In areas where the development is high, the atmospheric air quality is poor and is prone to serious atmospheric pollution problems, strict control of emissions shall be required in such key areas for TPS as categorised under Region 1.
 - In next phase may be after one year commissioning of 1st phase units, observing the effectiveness of installed equipment, to be implemented in the power plant which are located under Region 2
 - Presently no action is required for power plant those are situated under Region 3,4 & 5

Phasing of FGD Installation based on Ambient Air Quality SO₂ Levels

Region	Ambient Air SO ₂ Levels	Remarks
1	Level - I (>40µg/m ³)	FGD shall be installed immediately
2	Level-II (>30µg/m ³ & ≤40µg/m ³)	FGD shall be installed in 2nd phase
3	Level-III (>20µg/m ³ & ≤30µg/m ³)	FGD is not required at present
4	Level-IV (>10µg/m ³ & ≤20µg/m ³)	FGD is not required at present
5	Level-V (>0µg/m ³ & ≤10µg/m ³)	FGD is not required at present

Phasing of FGD may be considered as per Ambient Air Quality in vicinity of Power Plant

Impact of trading margin on ACoS



Present Market Segment

Share of short-term power market in total generation for FY2019-20 (in %)

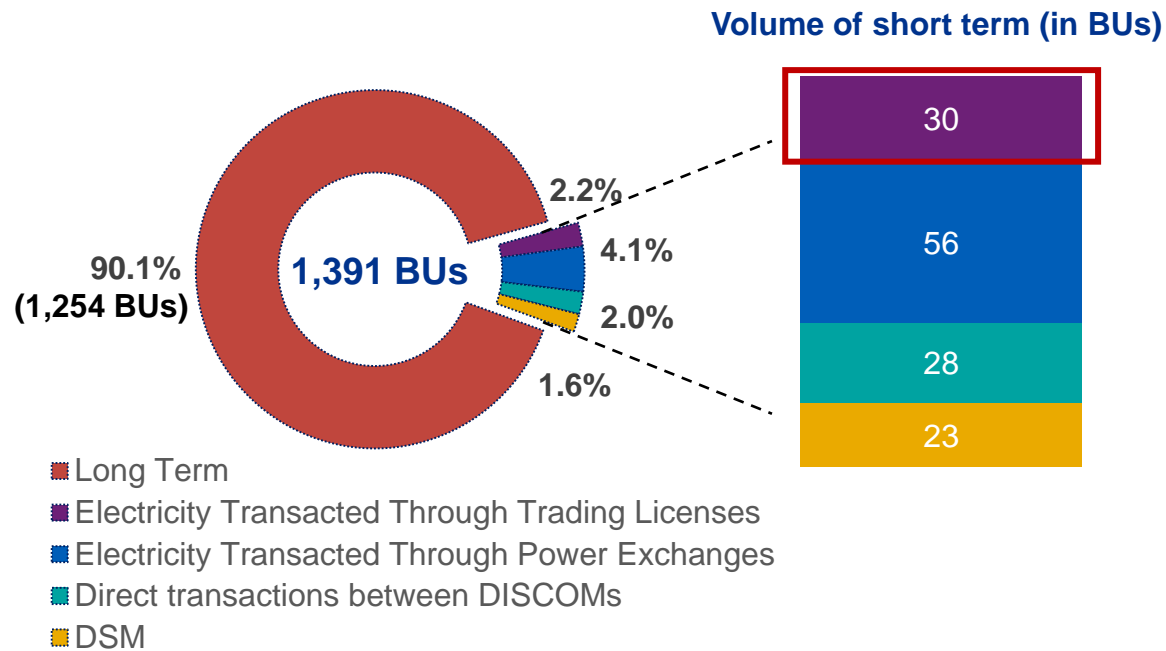

Volume of electricity transacted (in BUs) through exchange and trading licensees over the last 5 years

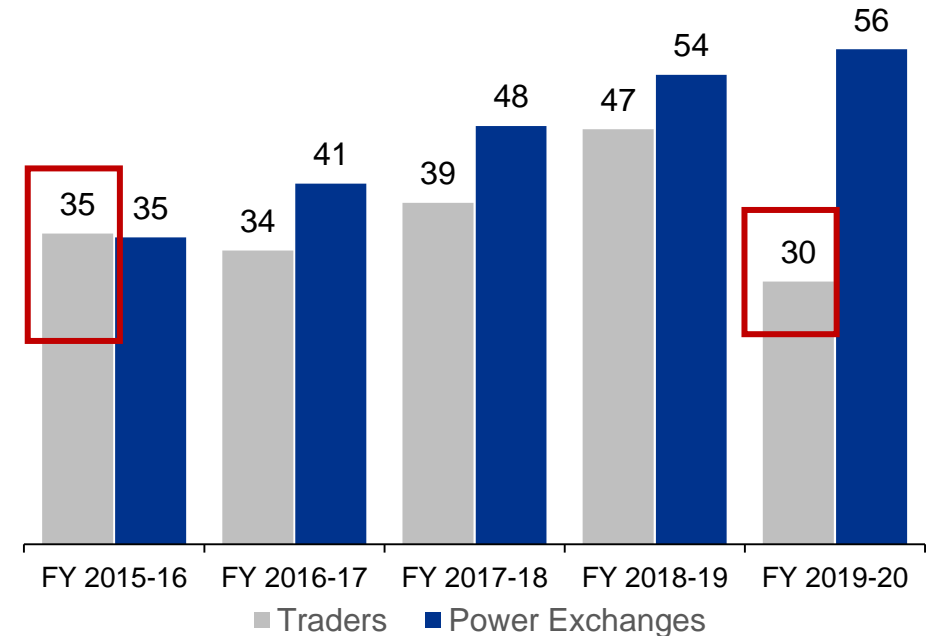

- Electricity transacted through trading Licensees (BU) is ~2% of the total generation
- The total volume of electricity transacted through traders has reduced with a CAGR~4% over the last 5 years

Trading margin charged by trading licensees

Regulations on trading margin over the years

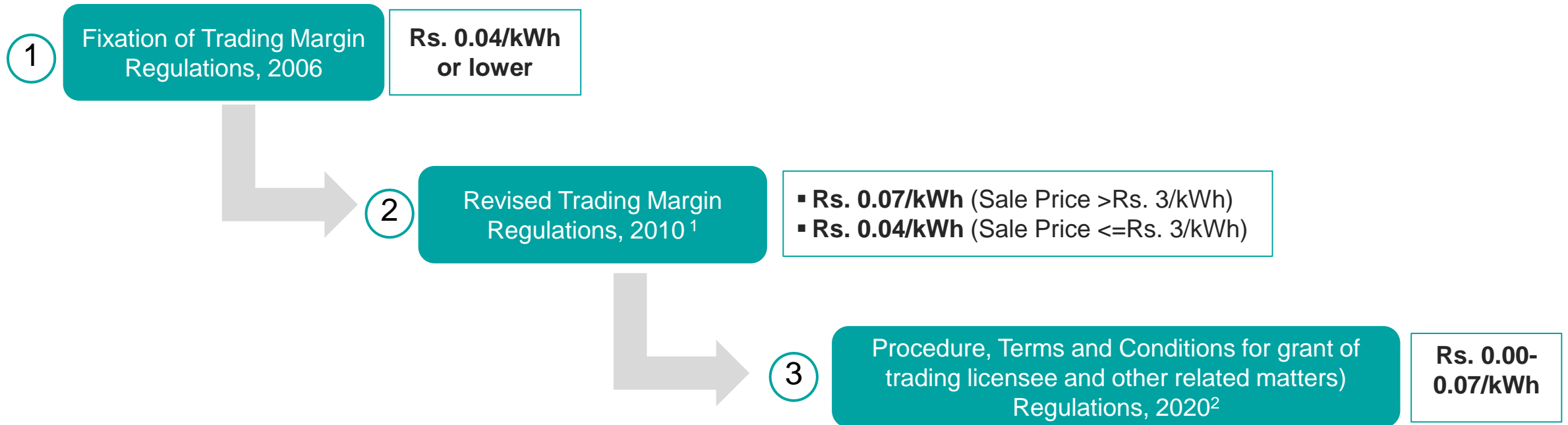

Source: http://www.cercind.gov.in/2020/market_monitoring/Annual%20Report%202019-20.pdf

1 The trading licensees were allowed to charge trading margin up to 7 paise/kWh in case the sale price exceeds `3/kWh, and 4 paise/kWh where the sale price is less than or equal to `3/kWh.

2 As per the CERC Regulations, 2020, the prescribed trading margin must be in the range of 0 to 7 paise/kWh

Trading margin charged by trading licensees

Average trading margin (in Rs./kWh) charged by trading licensees starting 2009-10

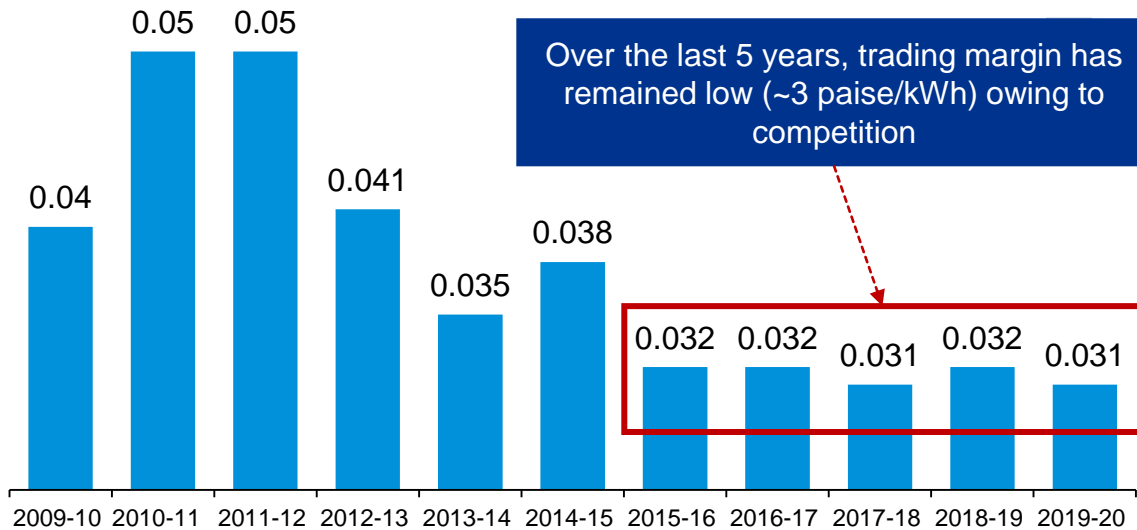

Average trading margin charged by trading licensees has varied in the range of Rs. 0.05-0.03/kWh over last 10 years

Impact of reduction of trading margin (in Rs. Crore)

Parameter	Value
Total volume transacted through trading licensees for FY20 (BUs)	30
Total contribution of trading margin for FY20 (Rs. Crore)	93
Impact of Rs. 0.01/kWh reduction in trading margin (in Rs. Crore)	30
Impact of Rs. 0.02/kWh reduction in trading margin (in Rs. Crore)	60

Reduction in trading margin by Rs. 0.02/kWh would only reduce the ACoS by Rs 0.001/kWh/ (0.01%)

Conclusion

Power purchase cost

- PPC accounts for ~67% to 78% of the total ACoS.
- Share of PPC in ACoS has reduced over the last 4 years, mainly due to increase in contribution of other cost components (such as O&M, interest & finance, depreciation, etc.)
- Fixed charges contribute around 25-40% whereas energy charges contribute around 60-70% to the overall PPC



Coal prices

- Coal price accounts for around 25% of landed cost of fuel.
- Coal prices (in last 4 yrs.) were about 28%¹ higher as compared to the price based on WPI and wt. avg. of WPI and CPI.



Railway freight

- Rail freight accounts for ~40% of landed cost of fuel
- Railway freight (in last 4 yrs.) was about ~30%² higher as compared to freight based on WPI and wt. avg. of WPI and CPI.



Clean Energy Cess

- Clean energy cess has increased from Rs. 50/Tonne in 2010 to Rs. 400/Tonne in 2016.
- Reduction of clean energy cess by Rs 50/MT may reduce the ACoS by around 3 paise per unit



Change in GCV

- Every 100 kcal/kg loss in GCV results in ~3% increase in energy charges



¹ Actual coal prices compared to coal prices based on WPI and wt. avg. of WPI & CPI during Jan' 2018

² Actual railway freight compared to freight based on WPI and wt. avg. of WPI & CPI during Nov' 2018

Conclusion

Depreciation

- Depreciation (for G, T & D utilities) accounted for 6% of the total ARR in FY 2020-21 for 12 states.
- Reduction of depreciation rate to 4.67% and 4.34% may reduce ACoS by Rs. 0.08kWh (1.2%) and Rs. 0.10kWh (1.4%) respectively



ROE

- ROE (for G, T & D utilities) accounted for 5% of the total ARR in FY 2020-21 for 12 states.
- Reduction of approved rate of ROE to 14% and 12% may reduce ACoS by Rs. Rs. 0.02/kWh (0.4%) and 0.07/kWh (1.0%) respectively



Distribution loss

- Approved distribution losses accounted for ~8% - 21% of ACoS for 12 states for FY 2020-21.
- Reduction of approved Distribution losses to 12% would reduce ACoS by Rs. 0.00-0.66/kWh (3%).



Transmission charges

- Inter-state transmission capacity has increased based on projected demand.
- Inter-state transmission charges have increased @ CAGR of 17% in last 10 years
- Competitive bidding has resulted in ~ 45-50% reduction in transmission charges



Other factors

- Retiring of inefficient old thermal power plants (>30 years old) may reduce energy charges by 4-23%.
- Merit Order Dispatch (MOD) Guidelines issued by MERC Maharashtra allows for “zero” scheduling of thermal power plants



Thank You

Contact Details

Udit Mathur

Energy Adviser

Foreign, Commonwealth & Development Office

udit.mathur1@fcdo.gov.uk

Anish De

Programme Director - Power Sector Reforms Programme

KPMG India

anishde@kpmg.com



Supporting Structural
Reforms in the
Indian Power Sector



<https://psrindia.com/>



https://twitter.com/psr_india



www.facebook.com/PSR-India-122338261759998/

Inter & Intra-State Transmission Charges (Rs. Crore & Rs./kWh)

Change in Transmission Cost over the last 4 years

Uttarakhand: Transmission Charges (Rs. Crore)

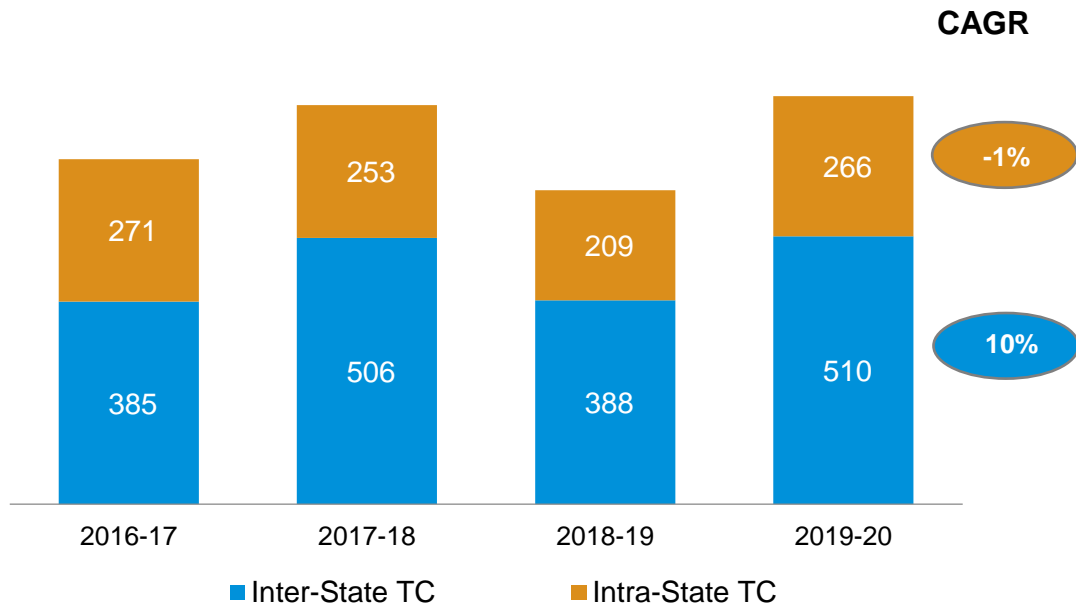

The share of inter-state transmission charges has increased in last 4 years whereas the share of intra-state transmission charges remain constant.

Uttarakhand: Transmission Charges* (Rs./kWh)

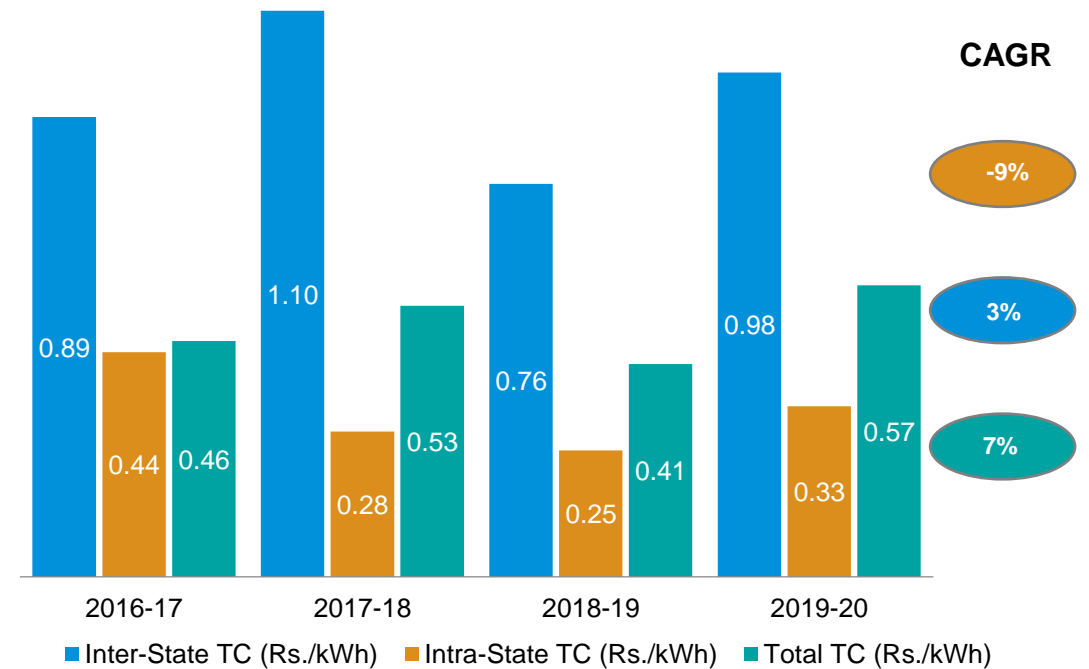

Per unit inter-state TC has increased over the last 4 years whereas the per unit intra-state TC has reduced.

Source: Tariff orders issued by respective state commissions for the last 4 years;

*Inter-state TC per unit is computed based on energy procured from ISGS and intra-state TC per unit is computed based on power procured from plants within the state

Inter & Intra-State Transmission Charges (Rs. Crore & Rs./kWh)

Change in Transmission Cost over the last 4 years

Madhya Pradesh: Transmission Charges (Rs. Crore)

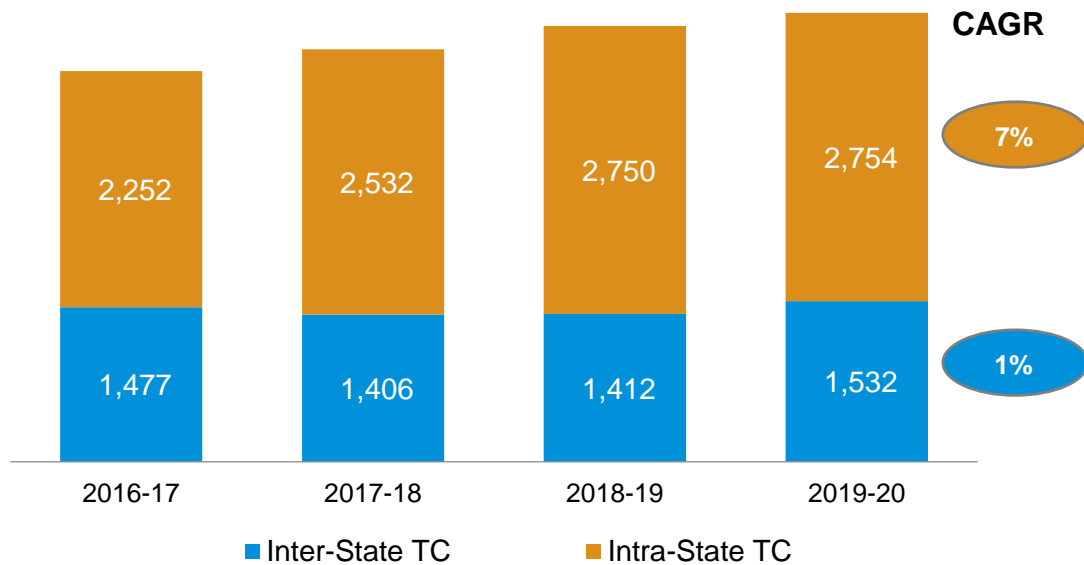

The share of intra-state transmission charges has increased in last 4 years whereas the share of inter-state transmission charges remain constant.

Madhya Pradesh: Transmission Charges* (Rs./kWh)

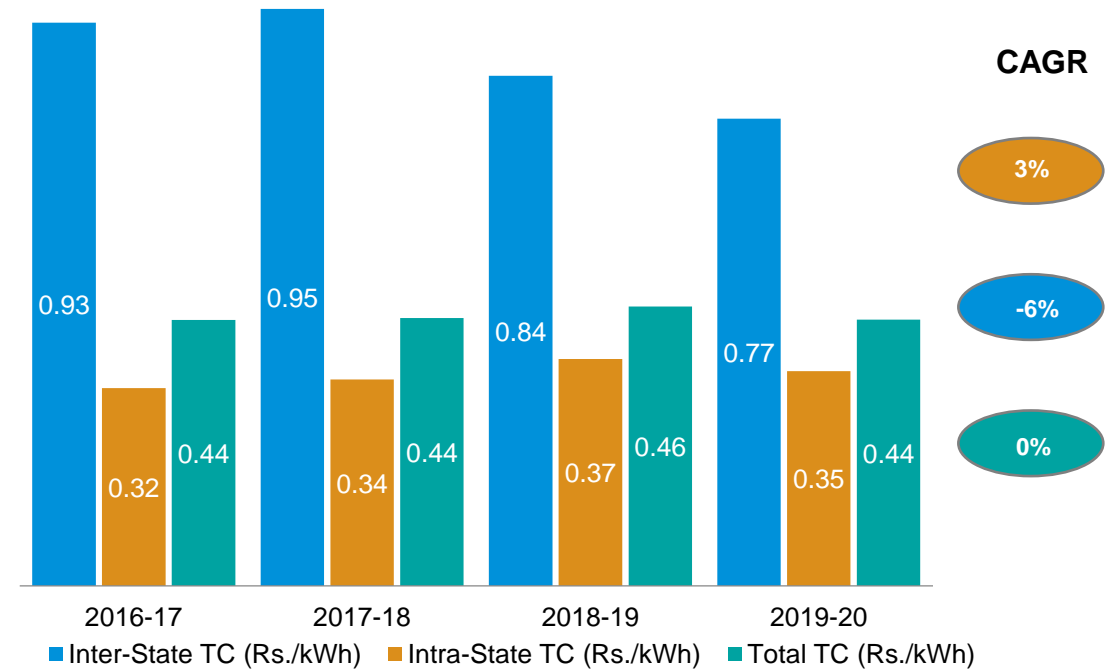

Per unit inter-state TC has reduced over the last 4 years whereas the per unit intra-state TC has increased

Source: Tariff orders issued by respective state commissions for the last 4 years;

*Inter-state TC per unit is computed based on energy procured from ISGS and intra-state TC per unit is computed based on power procured from plants within the state

Inter & Intra-State Transmission Charges (Rs. Crore & Rs./kWh)

Change in Transmission Cost over the last 4 years

Karnataka: Transmission Charges (Rs. Crore)

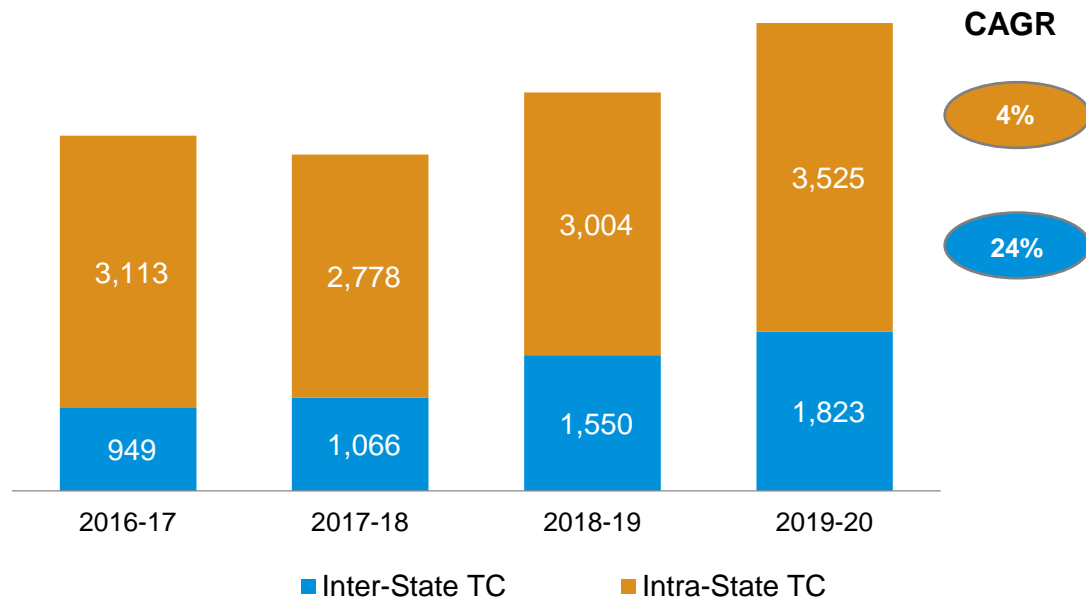

The share of Inter-State transmission charges has increased @ 24% CAGR in last 4 years whereas the share of Intra-State transmission charges has increased @ 4% CAGR only.

Karnataka: Transmission Charges* (Rs./kWh)

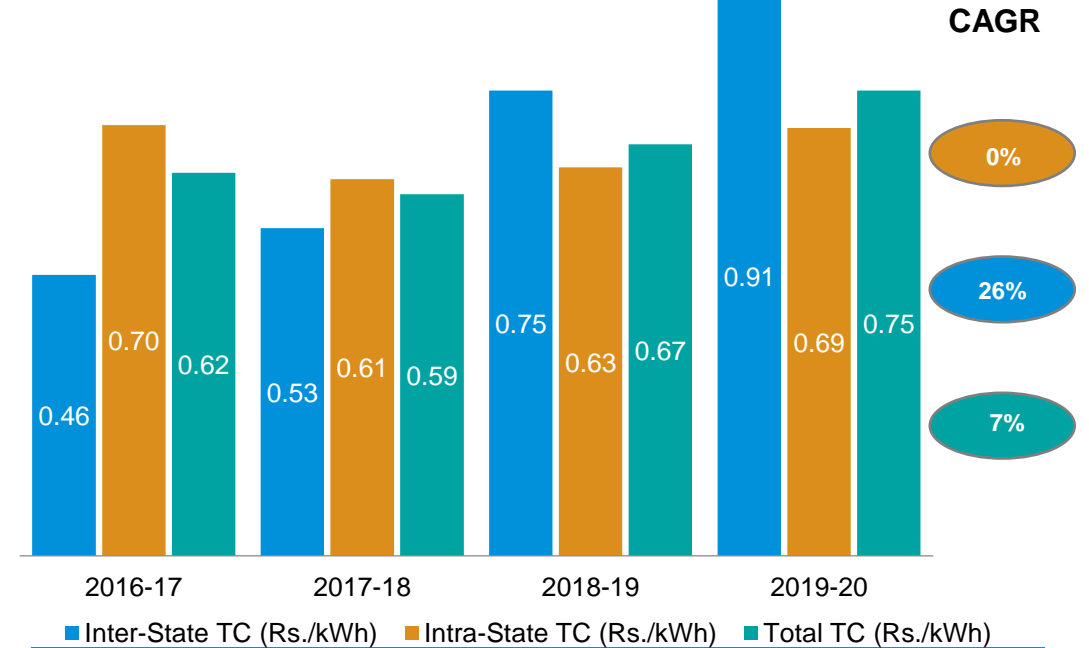

Per unit inter-state TC has increased significantly over the last 4 years whereas the per unit intra-state TC has remained the same

Source: Tariff orders issued by respective state commissions for the last 4 years;

*Inter-state TC per unit is computed based on energy procured from ISGS and intra-state TC per unit is computed based on power procured from plants within the state

Inter & Intra-State Transmission Charges (Rs. Crore & Rs./kWh)

Change in Transmission Cost over the last 4 years

Kerala : Transmission Charges (Rs. Crore)

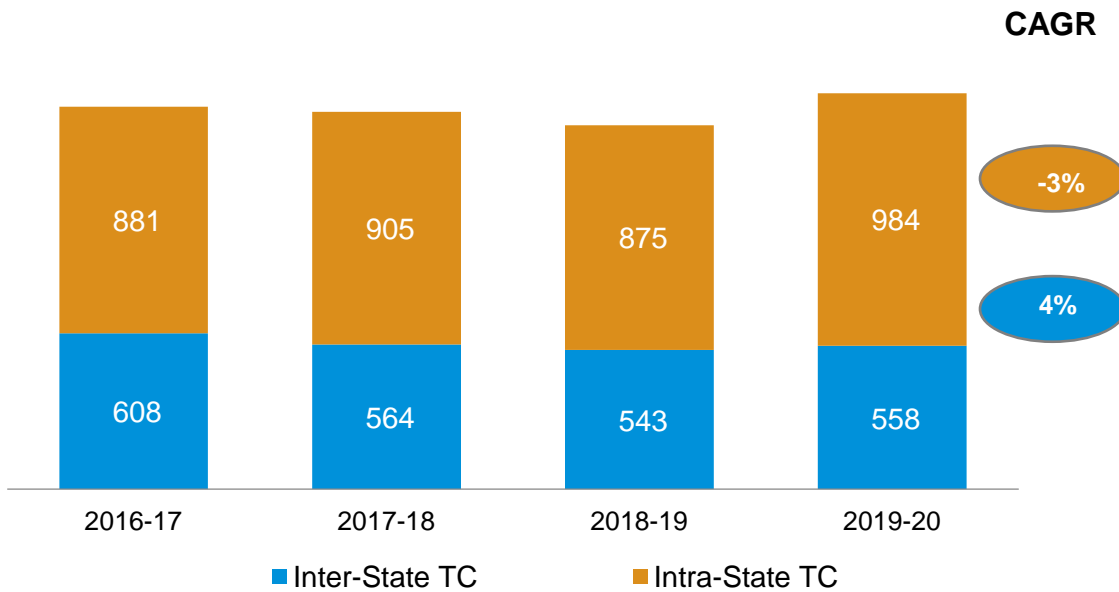

The share of intra-state transmission charges has decreased in last 4 years whereas the share of inter-state transmission charges has increased.

Kerala: Transmission Charges* (Rs./kWh)

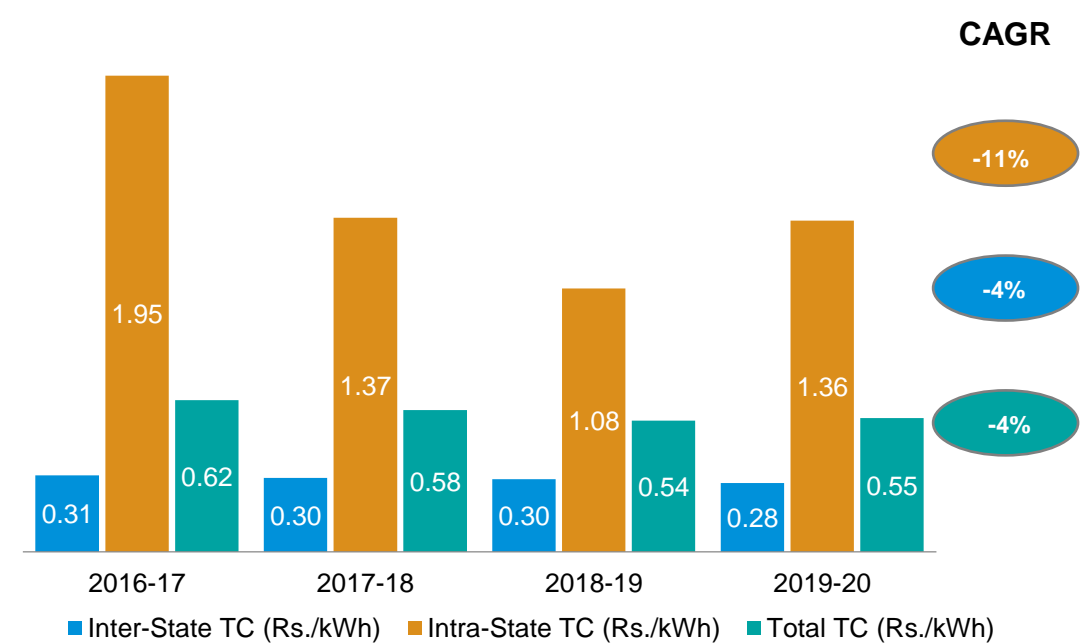

Per unit inter-state TC has decreased over the last 4 years whereas the per unit intra-state TC has reduced at a higher rate

Source: Tariff orders issued by respective state commissions for the last 4 years;

*Inter-state TC per unit is computed based on energy procured from ISGS and intra-state TC per unit is computed based on power procured from plants within the state

Inter & Intra-State Transmission Charges (Rs. Crore & Rs./kWh)

Change in Transmission Cost over the last 4 years

Jharkhand: Transmission Charges (Rs. Crore)

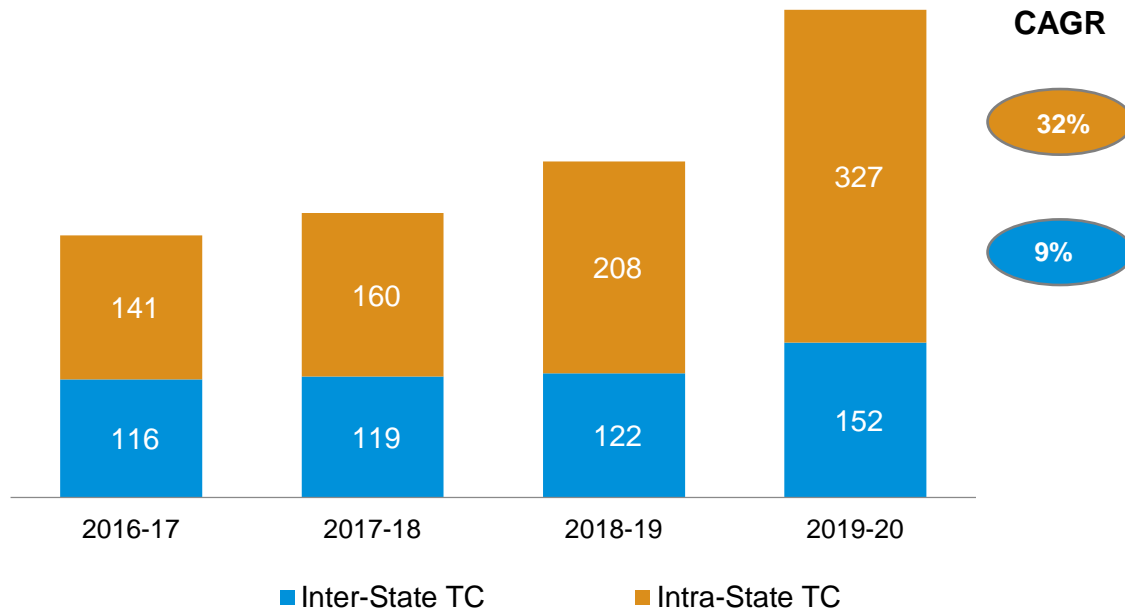

The share of Intra-state transmission charges has increased @ 32% CAGR in last 4 years whereas the share of inter-state transmission charges has increased @ 9% CAGR only.

Jharkhand: Transmission Charges (Rs./kWh)

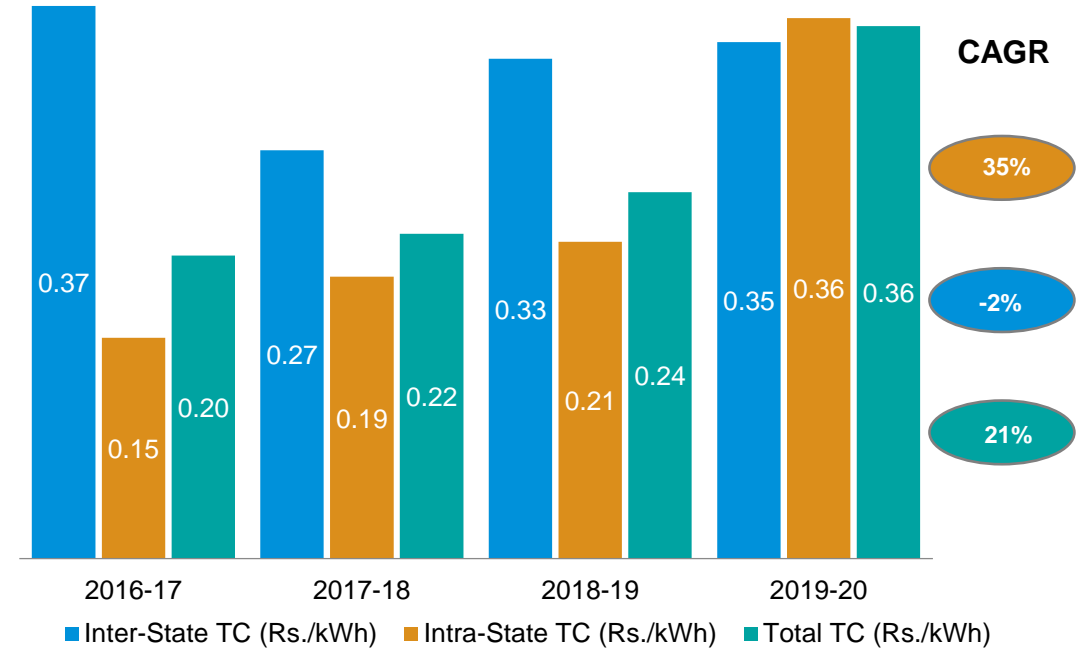

Per unit inter-state TC has decreased marginally over the last 4 years whereas per unit intra-state TC has increased significantly

Source: Tariff orders issued by respective state commissions for the last 4 years;

*Inter-state TC per unit is computed based on energy procured from ISGS and intra-state TC per unit is computed based on power procured from plants within the state

Inter & Intra-State Transmission Charges (Rs. Crore & Rs./kWh)

Change in Transmission Cost over the last 4 years

Assam: Transmission Charges (Rs. Crore)

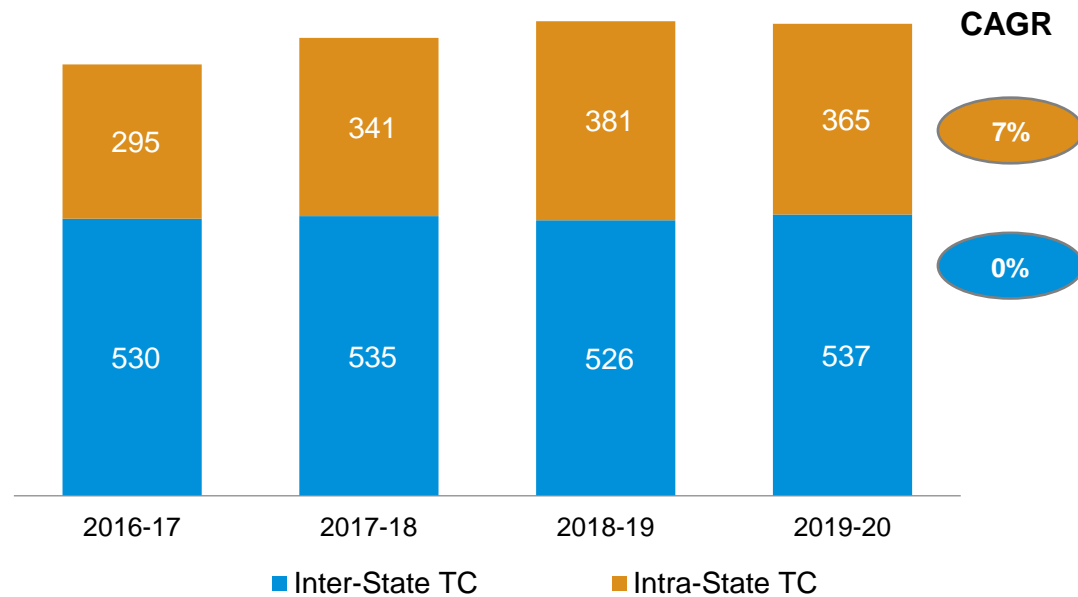

Assam: Transmission Charges (Rs./kWh)

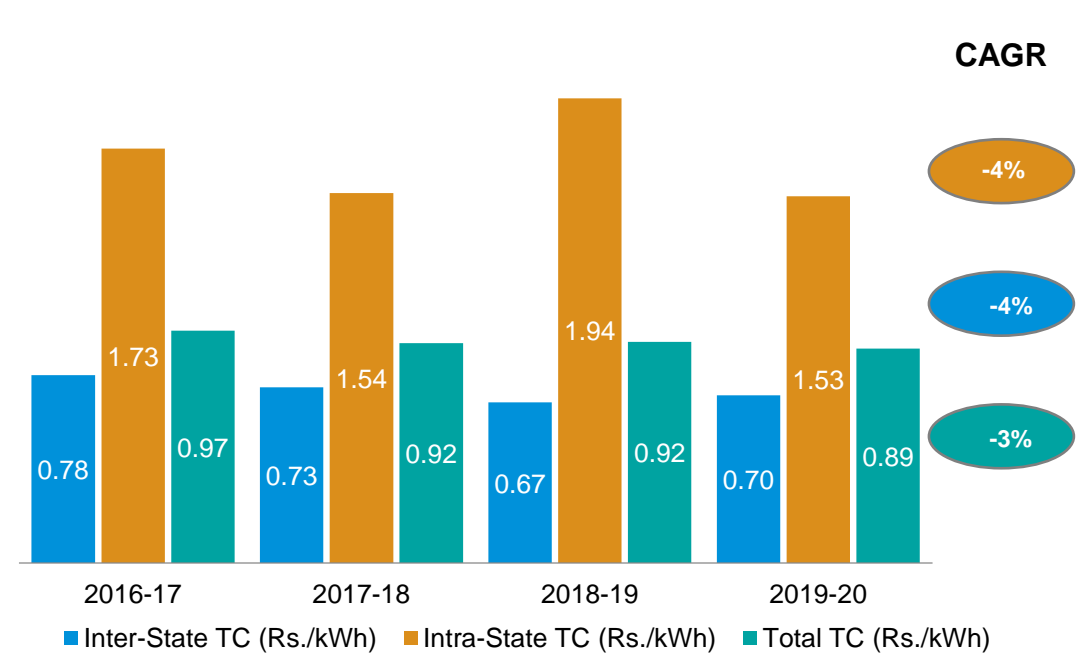

The share of intra-state transmission charges has increased in last 4 years whereas the share of inter-state transmission charges remain constant.

Per unit intra-state TC per unit and per unit inter-state TC has decreased over the last 4 years

Source: Tariff orders issued by respective state commissions for the last 4 years;

*Inter-state TC per unit is computed based on energy procured from ISGS and intra-state TC per unit is computed based on power procured from plants within the state

Inter & Intra-State Transmission Charges (Rs. Crore & Rs./kWh)

Change in Transmission Cost over the last 4 years

Bihar: Transmission Charges (Rs. Crore)

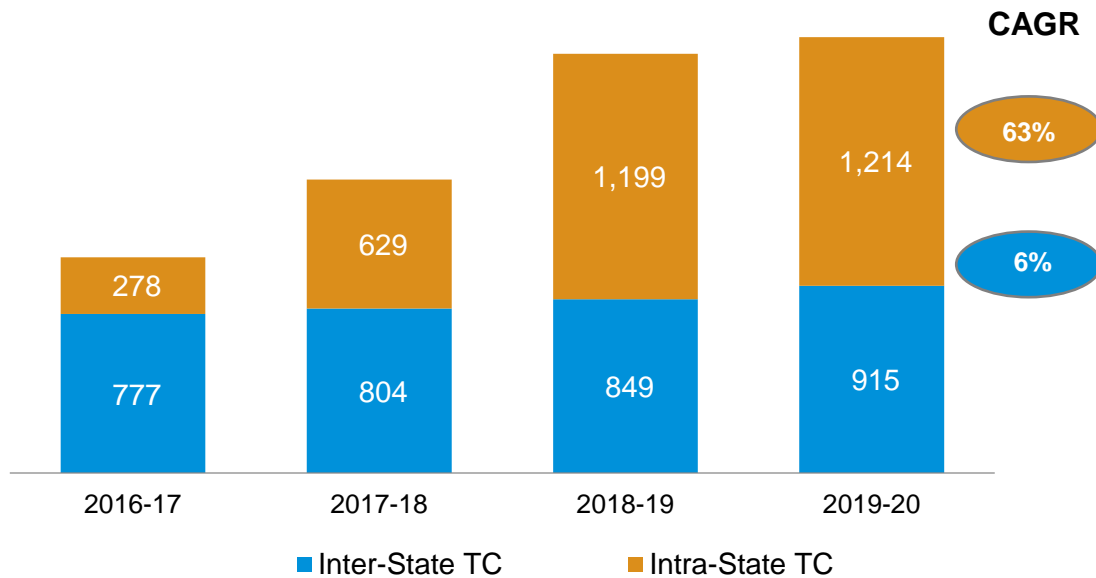

The share of intra-state transmission charges has increased at much higher rate in comparison to inter-state transmission charges in last 4 years.

Bihar: Transmission Charges (Rs./kWh)

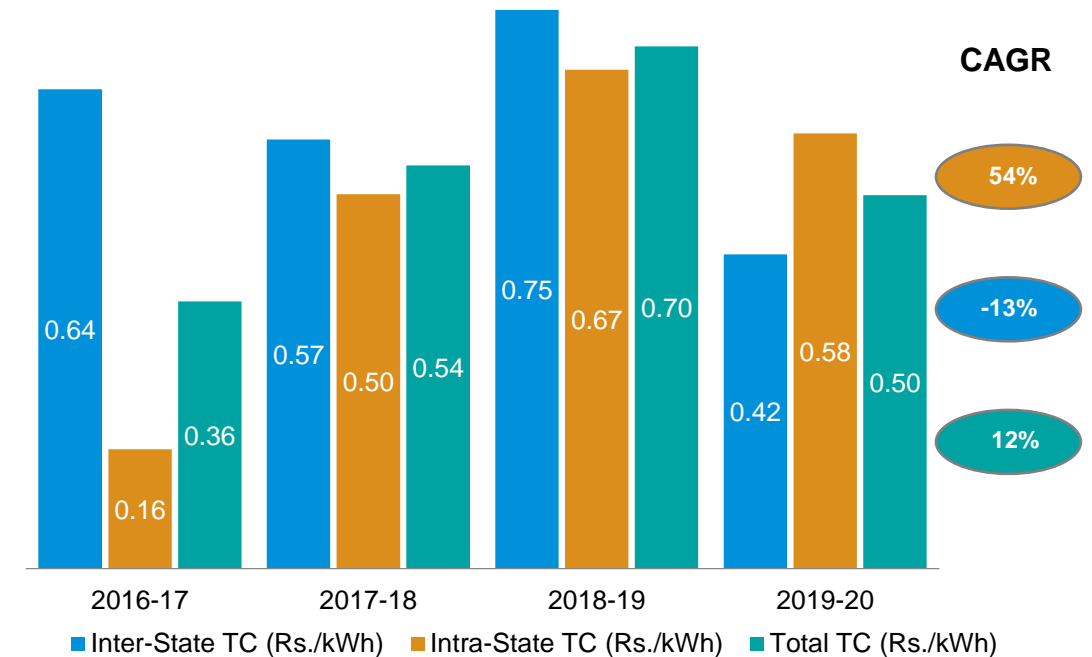

Per unit inter-state TC has decreased over the last 4 years whereas the per unit intra-state TC has increased significantly

Source: Tariff orders issued by respective state commissions for the last 4 years;

*Inter-state TC per unit is computed based on energy procured from ISGS and intra-state TC per unit is computed based on power procured from plants within the state

Inter & Intra-State Transmission Charges (Rs. Crore & Rs./kWh)

Change in Transmission Cost over the last 4 years

Haryana: Transmission Charges (Rs. Crore)

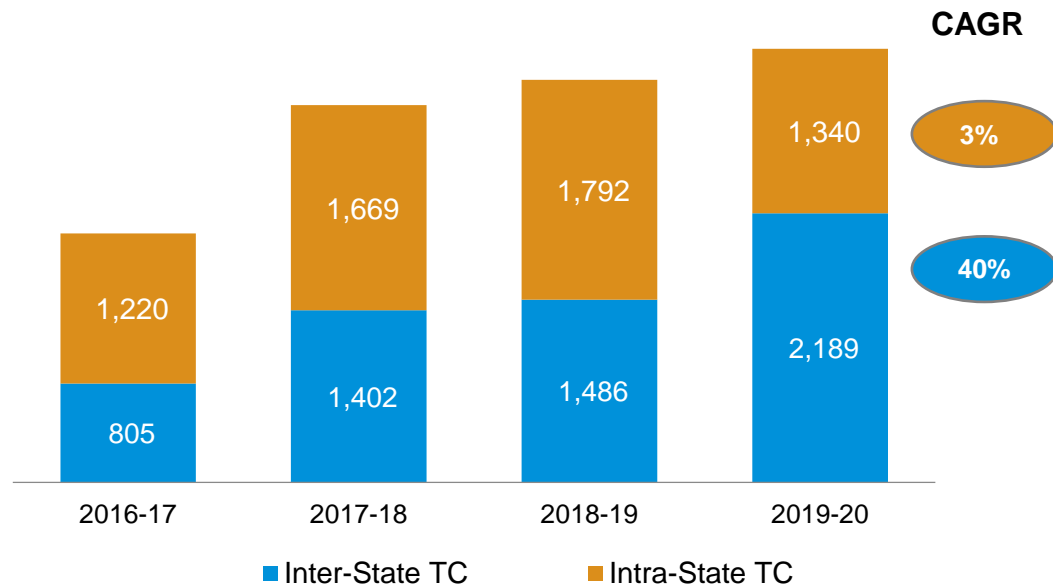

The share of inter-state transmission charges has increased at much higher rate in comparison to intra-state transmission charges in last 4 years,

Haryana: Transmission Charges (Rs./kWh)

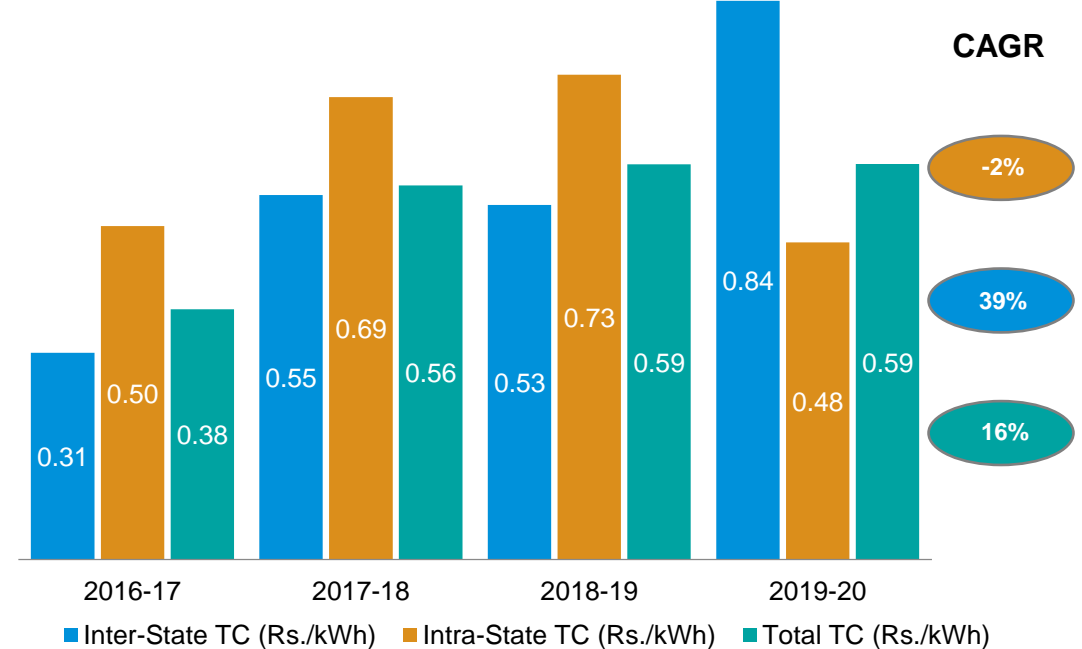

Per unit inter state TC has increased significantly over the last 4 years whereas the per unit intra-state TC has decreased marginally

Source: Tariff orders issued by respective state commissions for the last 4 years;

*Inter-state TC per unit is computed based on energy procured from ISGS and intra-state TC per unit is computed based on power procured from plants within the state

Inter & Intra-State Transmission Charges (Rs. Crore & Rs./kWh)

Change in Transmission Cost over the last 4 years

Uttar Pradesh: Transmission Charges (Rs. Crore)

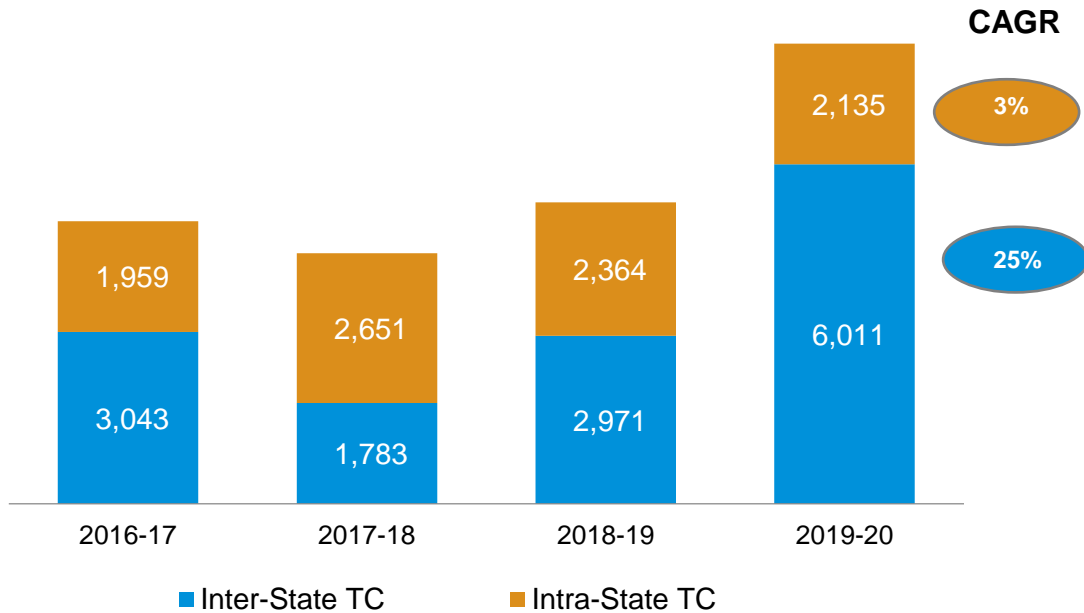

The share of intra-state transmission charges has remains constant in last 4 years, but inter-state transmission charges increased by 25% in last 4 years.

Uttar Pradesh: Transmission Charges (Rs./kWh)

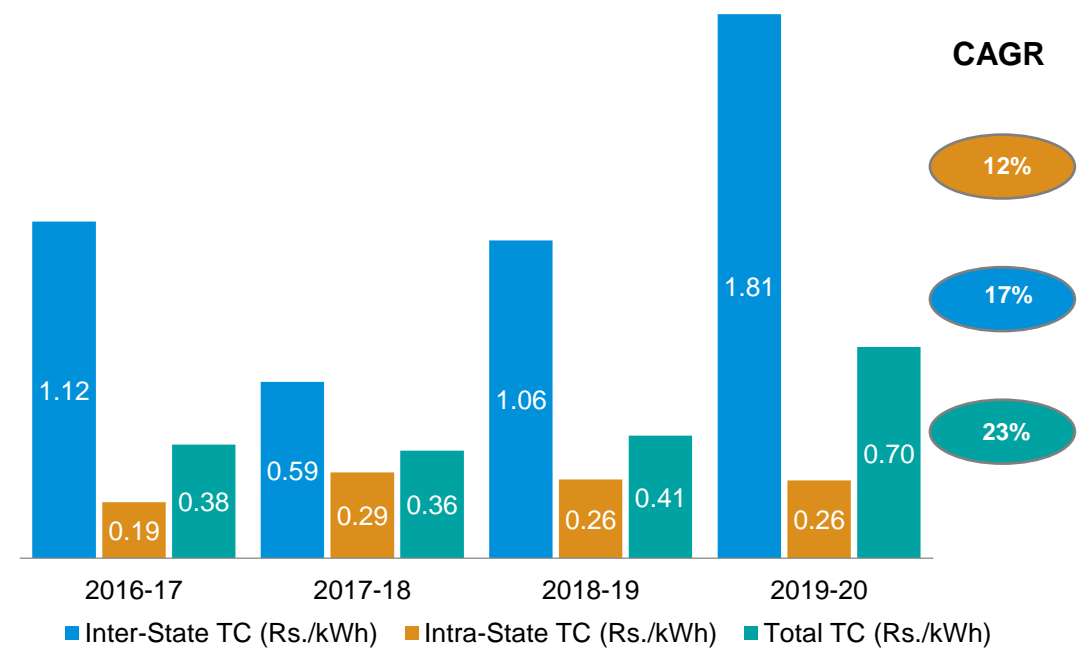

Per unit inter-state TC has increased over the last 4 years whereas the per unit intra-state TC has increased at a lower rate

Source: Tariff orders issued by respective state commissions for the last 4 years;

*Inter-state TC per unit is computed based on energy procured from ISGS and intra-state TC per unit is computed based on power procured from plants within the state

Inter & Intra-State Transmission Charges (Rs. Crore & Rs./kWh)

Change in Transmission Cost over the last 4 years

Andhra Pradesh: Transmission Charges (Rs. Crore)

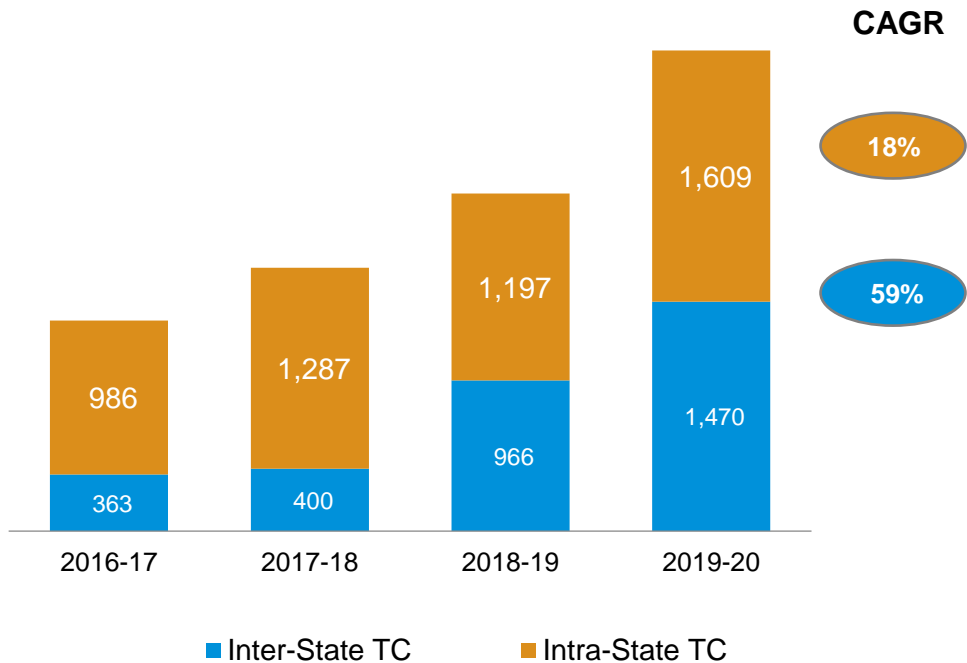

The share of inter-state transmission charges has increased at much higher rate in comparison to intra-state transmission charges in last 4 years,

Andhra Pradesh: Transmission Charges (Rs./kWh)

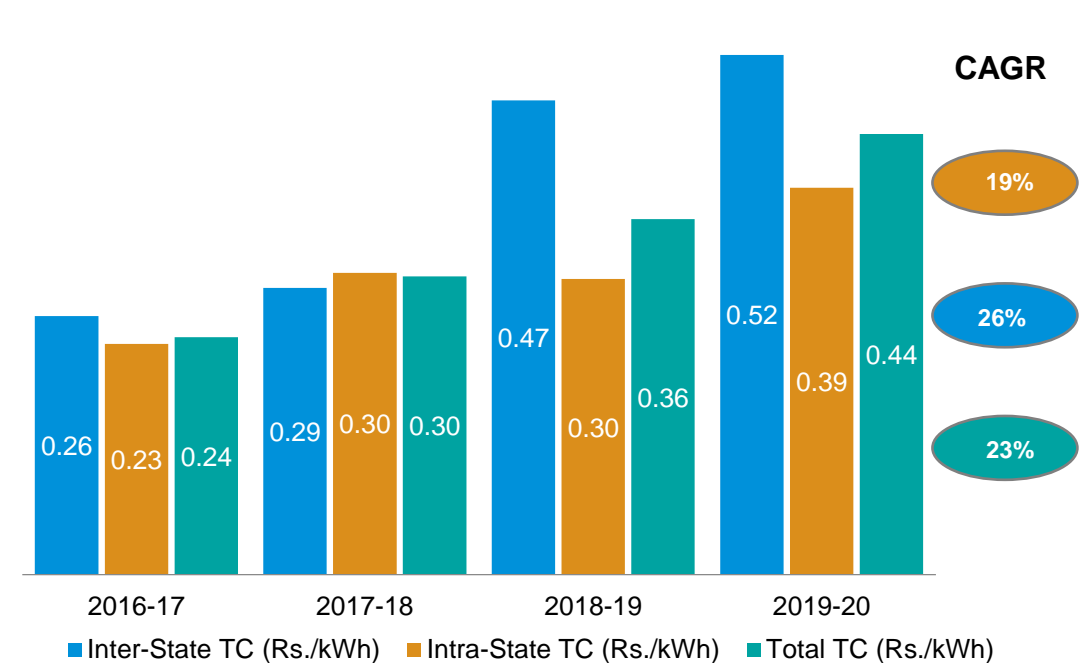

Per unit inter state TC has increased significantly over the last 4 years whereas the per unit intra-state TC has increased at a lower rate

Source: Tariff orders issued by respective state commissions for the last 4 years;

*Inter-state TC per unit is computed based on energy procured from ISGS and intra-state TC per unit is computed based on power procured from plants within the state

Inter & Intra-State Transmission Charges (Rs. Crore & Rs./kWh)

Change in Transmission Cost over the last 4 years

Gujarat: Transmission Charges (Rs. Crore)

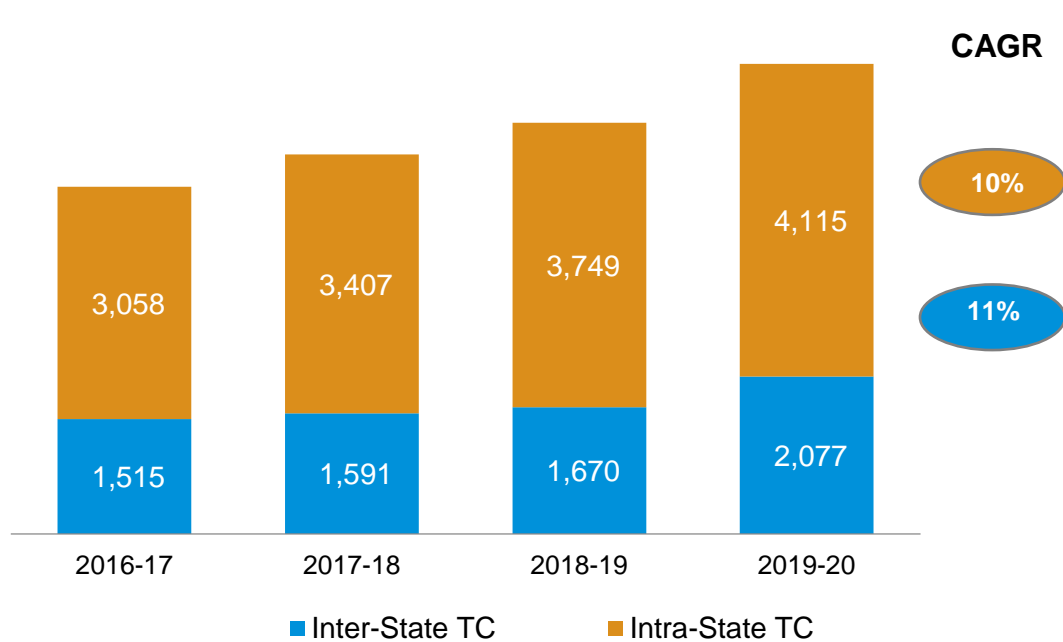

The share of intra & inter-state transmission charges has increased @ ~10% CAGR in last 4 years.

Gujarat: Transmission Charges (Rs./kWh)

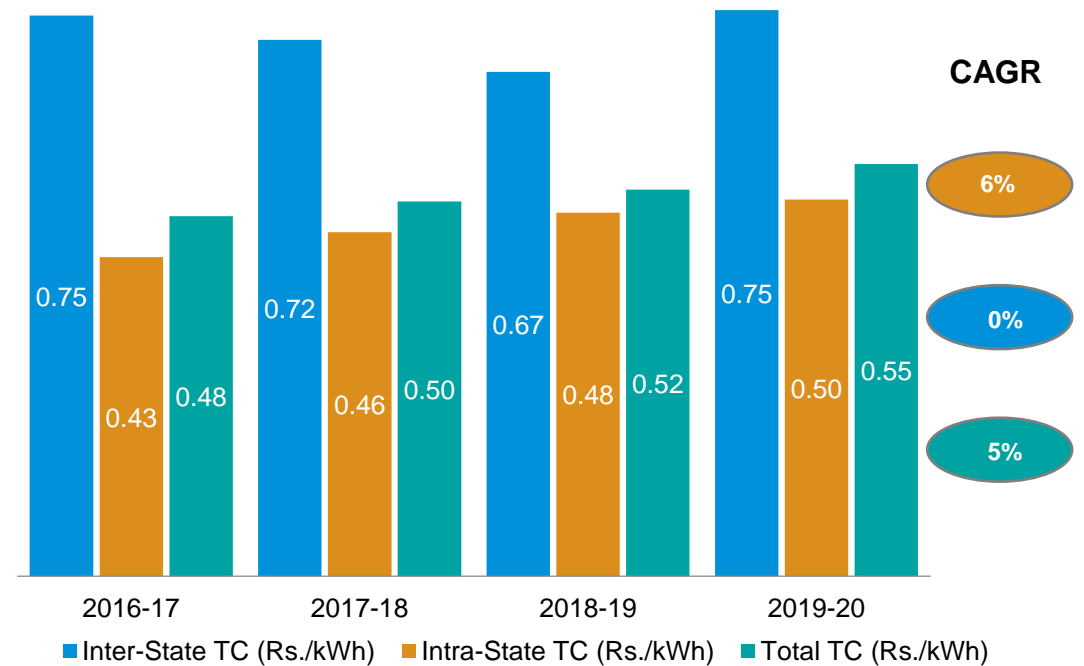

Per unit inter state TC has remained constant over the last 4 years whereas the per unit intra-state TC has increased

Source: Tariff orders issued by respective state commissions for the last 4 years;

*Inter-state TC per unit is computed based on energy procured from ISGS and intra-state TC per unit is computed based on power procured from plants within the state

Approved Power Purchase Cost for 12 States (Excluding Transmission Charges) for FY 2016-17 & FY 2017-18

S No.	States/UTs	2016-17		
		Sales (MU)	PPC (Rs. Cr)	PPC (Rs/kWh)
1	Uttarakhand	11,188	4,047	3.62
2	Assam	6,684	2,909	4.35
3	Kerala	20,626	7,818	3.79
4	Bihar	19,957	10,751	5.39
5	Madhya Pradesh	48,552	18,143	3.74
6	Odisha	19,302	6,703	3.47
7	Karnataka	52,769	22,649	4.29
8	Andhra Pradesh	49,991	21,151	4.23
9	Haryana	35,981	19,436	5.40
10	Jharkhand	8,651	4,489	5.19
11	Uttar Pradesh	94,599	50,698	5.36
12	Gujarat	69,658	29,266	4.20
	Total	437,958	198,060	4.52

S No.	States/UTs	2017-18		
		Sales (MU)	PPC (Rs. Cr)	PPC (Rs/kWh)
1	Uttarakhand	11,849	4,376	3.69
2	Assam	7,524	3,184	4.23
3	Kerala	21,840	7,453	3.41
4	Bihar	20,358	9,591	4.71
5	Madhya Pradesh	49,725	19,910	4.00
6	Odisha	19,775	6,969	3.52
7	Karnataka	54,699	22,776	4.16
8	Andhra Pradesh	50,077	21,491	4.29
9	Haryana	36,573	19,878	5.44
10	Jharkhand	9,223	4,859	5.27
11	Uttar Pradesh	92,094	48,017	5.21
12	Gujarat	85,962	31,215	3.63
	Total	459,699	199,719	4.34

[Back](#)

Approved Power Purchase Cost for 12 States (Excluding Transmission Charges) for FY 2018-19 & FY 2019-20

S No.	States/UTs	2018-19		
		Sales (MU)	PPC (Rs. Cr)	PPC (Rs/kWh)
1	Uttarakhand	11,888	4,930	4.15
2	Assam	7,784	3,235	4.16
3	Kerala	21,647	7,848	3.63
4	Bihar	22,527	12,370	5.49
5	Madhya Pradesh	52,652	20,287	3.85
6	Odisha	20,448	7,190	3.52
7	Karnataka	57,180	24,739	4.33
8	Andhra Pradesh	54,932	24,565	4.47
9	Haryana	36,549	20,654	5.65
10	Jharkhand	10,197	4,644	4.55
11	Uttar Pradesh	104,380	50,604	4.85
12	Gujarat	84,580	33,043	3.91
	Total	484,764	214,109	4.42

S No.	States/UTs	2019-20		
		Sales (MU)	PPC (Rs. Cr)	PPC (Rs/kWh)
1	Uttarakhand	12,938	5,176	4.00
2	Assam	7,930	3,821	4.82
3	Kerala	22,970	8,614	3.75
4	Bihar	27,512	12,875	4.68
5	Madhya Pradesh	55,638	21,718	3.90
6	Odisha	21,893	7,530	3.44
7	Karnataka	59,471	28,747	4.83
8	Andhra Pradesh	59,162	26,430	4.47
9	Haryana	41,786	21,207	5.08
10	Jharkhand	11,011	5,525	5.02
11	Uttar Pradesh	94,518	47,493	5.02
12	Gujarat	94,422	36,472	3.86
	Total	509,251	225,608	4.43

Estimation of national average power purchase cost data-CERC

State	Data Sources for APPC estimation for FY2019-20 by CERC	Source of data for analysis of key factors impacting tariff
J&K	No details available	PPC and transmission charges from retail tariff order for FY 2019-20.
Arunachal Pradesh	Tariff Order for FY 2018-19	
Bihar	PPC for FY2019-20 from APR order for FY 2019-20	
Jharkhand*	Power Purchase and Cost for FY2019-20 from APR Order for FY 2019-20 have been considered for JBVNL , TSL, TSUISL and DVC. For SAIL Bokaro, PPC for FY2019-20 has been considered from MYT Order for FY 2016-17 – FY 2020-21.	
Meghalaya	PPC for FY2019-20 from MYT Order for Control Period FY 2018-19 to FY 2020-21	
Nagaland	PPC for FY2019-20 from Order on review for the FY 2019-20 (20th March 2020)	
Tamil Nadu	PPC for FY2018-19 from Order on Determination of Tariff for Generation and Distribution (11th August 2017)	
Telangana	PPC for FY2018-19 from Tariff Order for FY 2018-19 (27th March 2018)	
Tripura	PPC for FY2019-20 from Order on ARR for FY 2016-17 – FY 2020-21 (1st Sep 2020)	
West Bengal	PPC from Tariff Orders of FY 2017-18	

*For the state of Jharkhand, only JBVNL has been considered for the PPC computation.

Transmission charges

Hypothesis: Inter-state transmission charges have increased disproportionately as compared to intra-state transmission charges

❑ Capital costs per ckt. Km for inter-state and intra-state transmission lines

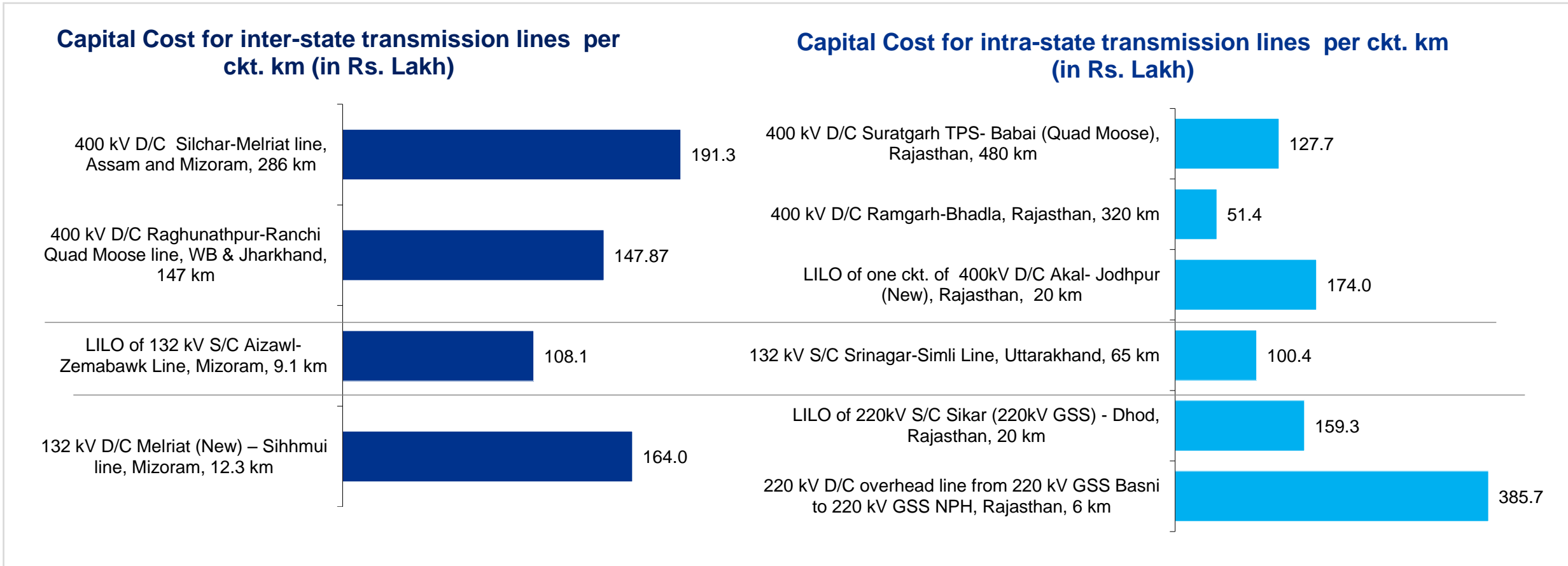

Capital costs per ckt. Km depends on the scope of transmission project (number of substations, transformation capacity, etc.).

*Source: Respective transmission tariff orders

Sector wise generation and inter state transmission charges

Type	2011-12	2012-13	2013-14	2014-15	2015-16	2016-17	2017-18	2018-19	2019-20
Central (A)	364005	375970	384905	395110	409343	433744	449512	461125	460268
State	367953	347154	350403	366803	344995	350938	377726	401132	387966
Private	139647	184138	226245	281752	348240	369842	374290	382672	396756
Imported	5285	4795	5598	5008	5244	5617	4778	4407	5794
Grand Total	876888	912057	967150	1048673	1107822	1160141	1206306	1249337	1250784

Year	FY 12	FY 13	FY 14	FY 15	FY 16	FY 17	FY 18	FY 19	FY 20
Annual Transmission charges (Rs Cr.) (B)	8743	12797	15118	17680	22476	27838	31405	35599	39285
Per Unit transmission charges (A/B*10)	0.24	0.34	0.39	0.45	0.55	0.64	0.70	0.77	0.85

[Back](#)

State-wise ABR and ACoS values across the years

S. No.	State	2017-18			2018-19			2019-20			CAGR	
		ACoS	ABR	Gap	ACoS	ABR	Gap	ACoS	ABR	Gap	ACoS	ABR
1	Andhra Pradesh	5.54	5.54	0.00	5.88	5.88	0.00	6.06	6.06	0.00	4%	4%
2	Assam	7.42	7.35	0.07	7.35	6.68	0.67	7.05	7.05	0.00	6%	5%
3	Bihar	6.70	7.12	(0.42)	7.21	7.16	0.05	6.59	7.14	(0.55)	6%	9%
4	Gujarat	5.19	5.63	(0.44)	5.89	5.70	0.19	5.98	5.68	0.30	3%	1%
5	Haryana	5.43	5.50	(0.06)	6.10	6.13	(0.03)	5.59	5.72	(0.13)	4%	2%
6	Jharkhand	6.63	6.48	0.16	7.24	7.89	(0.65)	6.51	5.69	0.81	2%	3%
7	Karnataka	6.41	6.41	0.00	6.75	6.75	0.00	7.20	7.20	0.00	7%	7%
8	Kerala	5.05	5.53	(0.48)	6.11	6.09	0.02	6.51	6.55	(0.04)	6%	7%
9	Madhya Pradesh	6.25	6.25	0.00	6.03	6.03	0.00	6.59	6.59	0.00	4%	4%
10	Odisha	4.69	4.70	(0.01)	4.68	4.69	(0.01)	4.77	4.77	0.00	1%	1%
11	Uttar Pradesh	6.47	5.64	0.83	6.73	5.75	0.98	7.35	6.71	0.64	4%	7%
12	Uttarakhand	4.92	4.92	0.00	5.05	5.06	(0.01)	5.28	5.32	(0.04)	4%	4%

ACoS ABR gap greater than 0	ACoS ABR gap lower than 0
-----------------------------	---------------------------

Key Observations

- While in some states like Uttar Pradesh, Gujarat and Jharkhand approved ACoS-ABR gap has been greater than 0 for the last few years, in other states (like Haryana, Odisha, Bihar, and Kerala), the gap has been lower than 0
- For states such as Karnataka, Andhra Pradesh and Uttarakhand, no ACoS-ABR gap has been approved over the years
- States such as Assam, Karnataka, Bihar and Kerala have witnessed high (>6%) annual growth in ACoS over the last 3 years

Back

State-wise rate of ROE and approved ROE

S. No.	State	DISCOMs			Intra-state transmission licensees			State GENCOs			Center GENCOs		
		FY	ROE(%)	ROE (in Rs. Crore)	FY	ROE(%)	ROE (in Rs. Crore)	FY	ROE(%)	ROE (in Rs. Crore)	FY	ROE(%)	ROE (in Rs. Crore)
1	Uttarakhand	2020-21	16.50%	115	2020-21	15.50%	39	2020-21	16%	99	2018-19	15.50%	147
2	Assam	2020-21	16.00%	26	2020-21	15.50%	15	2020-21	16%	44	2018-19	15.50%	159
3	Kerala	2020-21	14.00%	254	2020-21	14.00%	120	2020-21	14%	116	2018-19	15.50%	127
4	Bihar	2020-21	15.50%	460	2020-21	15.50%	338	2018-19	14%	245	2018-19	15.50%	273
5	Madhya Pradesh	2019-20	16.00%	787	2018-19	15.50%	388	2015-16	16%	653	2018-19	15.50%	785
6	Odisha	2020-21	16.00%	36	2019-20	15.50%	106	2019-20	16%	151	2018-19	15.50%	-
7	Karnataka	2019-20	15.50%	366	2020-21	15.50%	843	2018-19	16%	31	2018-19	15.50%	615
8	Andhra Pradesh	2020-21	13.23%	1,205	2020-21	14.00%	880	2020-21	12%	586	2018-19	15.50%	-
9	Haryana	2020-21	0.00%	-	2020-21	0.00%	-	2018-19	10%	211	2018-19	15.50%	299
10	Jharkhand	2020-21	15.50%	322	2020-21	15.50%	92	2020-21	16%	3	2018-19	15.50%	314
11	Uttar Pradesh	2019-20	16%	1,851	2020-21	2.00%	162	2018-19	16%	653	2018-19	15.50%	975
12	Gujarat	2020-21	14.00%	1,589	2020-21	14.00%	1,013	2020-21	14%	152	2018-19	15.50%	674

State-wise approved depreciation costs

S. No.	State	DISCOMs		Intra-state transmission licensees		State GENCOs		Central GENCOs	
		FY	Dep (In Rs Crores)	FY	Dep (In Rs Crores)	FY	Dep (In Rs Crores)	FY	Dep (In Rs Crores)
1	Uttarakhand	2020-21	167	2020-21	85	2020-21	167	2018-19	93
2	Assam	2020-21	24	2020-21	9	2020-21	42	2018-19	66
3	Kerala	2020-21	122	2020-21	223	2020-21	174	2018-19	34
4	Bihar	2020-21	386	2020-21	330	2018-19	299	2018-19	124
5	Madhya Pradesh	2019-20	426	2018-19	346	2016-17	797	2018-19	613
6	Odisha	2020-21	249	2019-20	162	2019-20	64	2018-19	-
7	Karnataka	2019-20	1,192	2020-21	840	2018-19	-	2018-19	513
8	Andhra Pradesh	2020-21	1,089	2020-21	623	2020-21	168	2018-19	-
9	Haryana	2020-21	651	2020-21	425	2018-19	368	2018-19	150
10	Jharkhand	2020-21	411	2020-21	266	2020-21	2	2018-19	365
11	Uttar Pradesh	2019-20	1,779	2020-21	989	2018-19	472	2018-19	524
12	Gujarat	2020-21	1,951	2020-21	1,356	2020-21	1,313	2018-19	513

[Back](#)

Impact of Retiring Old Coal based TPPs: Gujarat

Hypothesis: Retiring of Old Power Plants may lead to significant reduction in Electricity Tariff

❑ Detailed analysis of Key Parameters (as per Norms) of Old Vs. latest Coal based Thermal Power Plants

Sl. No.	State	Sector	Owner	Name of Project	Prime Mover	Unit No.	Total Units	Installed Capacity (MW)	Year of Comm.
1	Gujarat	State Sector	GSECL	WANAKBORI TPS	Steam	1 to 6	6	1260	1982 to 1987
2	Gujarat	Private Sector	Torrent Power Ltd	SABARMATI (D-F STATIONS)	Steam	1 to 3	3	360	1978 to 1988
3	Gujarat	State Sector	GSECL	UKAI TPS	Steam	3 to 5	3	610	1979, 1985

WANAKBORI TPS - Particulars	Unit	Actual Norms, as per TO	Norms, as per TO applicable for Latest Generating Station
Installed Capacity	MW	1260	1260
Plant Load Factor (%)	%	85%	85%
Gross Generation	MU	6838.0	6838.0
Auxiliary Consumption	%	9.00%	8.00%
Net Generation	MU	6222.6	6291.0
Station Heat Rate	kCal/kWh	2625.0	2385.0
Secondary Fuel Oil Consumption	ml/kWh	1	1
Price of oil	Rs./kL	37,330	37330.0
Price of coal	Rs./MT	2,486.75	2486.8
Energy Charge Rate (Ex-bus)	Rs./kWh	1.81	1.63
Reduction in Energy Charge Rate @ (Ex-bus)		10%	

UKAI TPS - Particulars	Unit	Actual Norms, as per TO	Norms, as per TO applicable for Latest Generating Station
Installed Capacity	MW	610	610
Plant Load Factor (%)	%	85%	85%
Gross Generation	MU	3206.8	3206.8
Auxiliary Consumption	%	9.00%	8.00%
Net Generation	MU	2918.2	2950.2
Station Heat Rate	kCal/kWh	2715.0	2385.0
Price of oil	Rs./kL	33170.0	33170.0
Price of coal	Rs./MT	3645.9	3645.9
Energy Charge Rate (Ex-bus)	Rs./kWh	2.87	2.49
Reduction in Energy Charge Rate @ (Ex-bus)		13%	

SABARMATI (D-F STATIONS) - Particulars	Unit	Actual Norms, as per TO	Norms, as per TO applicable for Latest Generating Station
Installed Capacity	MW	360	360
Plant Load Factor (%)	%	87%	87%
Gross Generation	MU	2785.66	2785.66
Auxiliary Consumption	%	9.00%	8.00%
Net Generation	MU	2535.0	2562.8
Station Heat Rate	kCal/kWh	2455.0	2385.0
Secondary Fuel Oil Consumption	ml/kWh	1	1
Price of oil	Rs./kL	37,330	37330.0
Price of coal	Rs./MT	2,486.75	2486.8
Energy Charge Rate (Ex-bus)	Rs./kWh	1.51	1.45
Reduction in Energy Charge Rate @ (Ex-bus)		4%	

- ❑ There is a reduction of about 4% to 13% in Energy Charges, in case the norms for latest thermal generating station is applied to old thermal generating station which is more than 30 years old.
- ❑ As per Distribution company Tariff Order there is an Energy Surplus of ~ 13,240 MU (1500 MW approximately).
- ❑ Supply from Old Power Plants to the extent of Energy Surplus can be discontinued which leads to significant reduction in Electricity Tariff.

Impact of Retiring Old Coal based TPPs: Madhya Pradesh

Hypothesis: Retiring of Old Power Plants may lead to significant reduction in Electricity Tariff

❑ Detailed analysis of Key Parameters (as per Norms) of Old Vs. latest Coal based Thermal Power Plants

Sl. No.	State	Sector	Owner	Name of Project	Prime Mover	Unit No.	Total Units	Installed Capacity (MW)	Year of Comm.
1	Madhya Pradesh	State Sector	MPPGCL	SATPURA TPS	Steam	6 to 9	4	800	1979 to 1984
2	Madhya Pradesh	Central Sector	NTPC	VINDHYACHAL STPS*	Steam	1 to 5	5	1050	1987 to 1990

* The approved norms for Vindhyachal STPS is comparable to New Station.

SATPURA TPS - Particulars	Unit	Actual Norms, as per TO	Norms, as per TO applicable for Latest Generating Station
Installed Capacity	MW	830	830
Plant Load Factor (%)	%	85%	85%
Gross Generation	MU	6180.18	6180.18
Auxiliary Consumption	%	10.00%	6.25%
Net Generation	MU	5,562.16	5,793.92
Station Heat Rate	kCal/kWh	2700	2375
Secondary Fuel Oil Consumption	ml/kWh	1.75	0.5
Price of oil	Rs./kL	43934.0	43934.0
Price of coal	Rs./MT	3217.3	3217.3
Energy Charge Rate (Ex-bus)	Rs./kWh	2.83	2.38
Reduction in Energy Charge Rate @ (Ex-bus)		16%	

Energy Availability & Requirement						
State	FY	Energy Availability (MU)	Energy Requirement (MU)	Energy Surplus (MU)	Approx. Surplus in MW	Old Coal based TPPs (>30 Years Old), MW
Madhya Pradesh	2019-20	97,989	69,353	28,636	3,268.95	1850

- ❑ There is a reduction of about 16% in Energy Charges for Satpura thermal station, in case the norms for latest thermal generating station is applied to old thermal generating station which is more than 30 years old.
- ❑ As per Distribution company Tariff Order there is an Energy Surplus of ~ 28,000 MU or ~ 3,200 MW approximately.
- ❑ From the numbers provided in above table, it is observed that the supply from Old Power Plants can be discontinued as Surplus Power is more than the MW capacity of Old Coal based TPPs, which leads to significant reduction in Electricity Tariff.

Impact of Retiring Old Coal based TPPs: Bihar

Hypothesis: Retiring of Old Power Plants may lead to significant reduction in Electricity Tariff

❑ Detailed analysis of Key Parameters (as per Norms) of Old Vs. latest Coal based Thermal Power Plants

Sl. No.	State	Sector	Owner	Name of Project	Prime Mover	Unit No.	Total Units	Installed Capacity (MW)	Year of Comm.
1	Bihar	Central Sector	NTPC	BARAUNI TPS*	Steam	6 & 7	2	210	1983
2	Bihar	Central Sector	KBUNL	MUZAFFARPUR TPS	Steam	1 & 2	2	220	1985

MUZAFFARPUR TPS - Particulars	Unit	Actual Norms, as per TO	Norms, as per TO applicable for Latest Generating Station
Installed Capacity	MW	220	220
Plant Load Factor (%)	%	85%	85%
Gross Generation	MU	1638.12	1638.12
Auxiliary Consumption	%	12.00%	9.00%
Net Generation	MU	1,441.55	1,490.69
Station Heat Rate	kCal/kWh	3000	2430
Secondary Fuel Oil Consumption	ml/kWh	1	0.5
Price of oil	Rs./kL	78122.76	78122.76
Price of coal	Rs./MT	4,331.63	4,331.63
Energy Charge Rate (Ex-bus)	Rs./kWh	3.82	2.99
Reduction in Energy Charge Rate @ (Ex-bus)		22%	

- ❑ There is a reduction of about 22% in the Energy Charges, in case the norms for latest thermal generating station is applied to old thermal generating station which is more than 30 years old.
- ❑ There is very less gap between Energy Availability and Requirement, almost all the available Energy is utilized by the State Discom. Retiring Old coal based TPPs in Bihar will have to be replaced with new capacity.

Energy Availability & Requirement						
State	FY	Energy Availability (MU)	Energy Requirement (MU)	Energy Surplus (MU)	Approx. Surplus in MW	Old Coal based TPPs (>30 Years Old), MW
Bihar	2020-21	32,384	31,893	491	56.03	430

* Tariff Oder is not available in public domain because these two units (6 & 7) are temporarily shutdown for R&M since 2015-16.

Impact of Retiring Old Coal based TPPs: Odisha

Hypothesis: Retiring of Old Power Plants may lead to significant reduction in Electricity Tariff

❑ Detailed analysis of Key Parameters (as per Norms) of Old Vs. latest Coal based Thermal Power Plants

Sl. No.	State	Sector	Owner	Name of Project	Prime Mover	Unit No.	Total Units	Installed Capacity (MW)	Year of Comm.
1	Odisha	Central Sector	NTPC	TALCHER (OLD) TPS	Steam	1 to 6	6	460	1967 to 1983

TALCHER (OLD) TPS - Particulars	Unit	Actual Norms, as per TO	Norms, as per TO applicable for Latest Generating Station
Installed Capacity	MW	460	460
Plant Load Factor (%)	%	85%	85%
Gross Generation	MU	3425.16	3425.16
Auxiliary Consumption	%	10.50%	8.50%
Net Generation	MU	3,065.52	3,134.02
Station Heat Rate	kCal/kWh	2850	2430
Secondary Fuel Oil Consumption	ml/kWh	0.5	0.5
Price of oil	Rs./kL	52224.37	52224.37
Price of coal	Rs./MT	1,166.20	1,166.20
Energy Charge Rate (Ex-bus)	Rs./kWh	0.99	0.83
Reduction in Energy Charge Rate @ (Ex-bus)			17%

- ❑ There is a reduction of about 17% in the Energy Charges, in case the norms for latest thermal generating station is applied to old thermal generating station which is more than 30 years old.
- ❑ There is very less gap between Energy Availability and Requirement, almost all the available Energy is utilized by the State Discom. Retiring Old coal based TPPs will have to be replaced with new capacity.

Impact of Retiring Old Coal based TPPs: Uttar Pradesh

Hypothesis: Retiring of Old Power Plants may lead to significant reduction in Electricity Tariff

❑ Detailed analysis of Key Parameters (as per Norms) of Old Vs. latest Coal based Thermal Power Plants

Sl. No.	State	Sector	Owner	Name of Project	Prime Mover	Unit No.	Total Units	Installed Capacity (MW)	Year of Comm.
1	Uttar Pradesh	Central Sector	NTPC	TANDA TPS	Steam	1 to 3	3	330	1988 to 1990
2	Uttar Pradesh	Central Sector	NTPC	RIHAND STPS*	Steam	1 & 2	2	1000	1988, 1989
3	Uttar Pradesh	Central Sector	NTPC	SINGRAULI STPS	Steam	1 to 7	7	2000	1982 to 1987
4	Uttar Pradesh	State Sector	UPRVUNL	ANPARA TPS*	Steam	1 to 3	3	630	1986 to 1989
5	Uttar Pradesh	State Sector	UPRVUNL	HARDUAGANJ TPS	Steam	7	1	105	1978

* The approved norms for Rihand & Anpara TPS is comparable to New Station.

TANDA TPS - Particulars	Unit	Actual Norms, as per TO	Norms, as per TO applicable for Latest Generating Station
Installed Capacity	MW	330	330
Plant Load Factor (%)	%	85%	85%
Gross Generation	MU	2457.18	2457.18
Auxiliary Consumption	%	12.00%	8.50%
Net Generation	MU	2,162.32	2,248.32
Station Heat Rate	kCal/kWh	2750	2430
Secondary Fuel Oil Consumption	ml/kWh	0.5	0.5
Price of oil	Rs./kL	58248.61	58248.61
Price of coal	Rs./MT	4,035.21	4,035.21
Energy Charge Rate (Ex-bus)	Rs./kWh	2.37	2.01
Reduction in Energy Charge Rate @ (Ex-bus)		15%	

HARDUAGANJ TPS (6 & 7) - Particulars	Unit	Actual Norms, as per TO	Norms, as per TO applicable for Latest Generating Station
Installed Capacity	MW	165	165
Plant Load Factor (%)	%	65%	85%
Gross Generation	MU	939.51	1228.59
Auxiliary Consumption	%	11.00%	9.00%
Net Generation	MU	836.16	1,118.02
Station Heat Rate	kCal/kWh	3150	2475
Secondary Fuel Oil Consumption	ml/kWh	3.7	3.7
Price of oil	Rs./kL	33,122.60	33,122.60
Price of coal	Rs./MT	4,705.49	4,705.49
Energy Charge Rate (Ex-bus)	Rs./kWh	3.86	2.97
Reduction in Energy Charge Rate @ (Ex-bus)		23%	

SINGRAULI STPS - Particulars	Unit	Actual Norms, as per TO	Norms, as per TO applicable for Latest Generating Station
Installed Capacity	MW	2000	2000
Plant Load Factor (%)	%	85%	85%
Gross Generation	MU	14892	14892
Auxiliary Consumption	%	6.88%	5.75%
Net Generation	MU	13,867.43	14,035.71
Station Heat Rate	kCal/kWh	2412.5	2226.09
Secondary Fuel Oil Consumption	ml/kWh	0.5	0.5
Price of oil	Rs./kL	48,311.61	48,311.61
Price of coal	Rs./MT	1,564.66	1,564.66
Energy Charge Rate (Ex-bus)	Rs./kWh	0.88	0.80
Reduction in Energy Charge Rate @ (Ex-bus)		15%	

- ❑ There is a reduction of up to 23% in Energy Charges, in case the norms for latest thermal generating station is applied to old thermal generating station which is more than 30 years old.
- ❑ In case of Uttar Pradesh the surplus energy is only 2.2% of total Energy Requirement but the capacity of Old coal based TPPs are much higher. Retiring Old coal based TPPs will have to be replaced with new capacity

Merit Order Dispatch (MOD): Issues & Guidelines (1/3)

	IDENTIFIED ISSUES	GUIDELINES
1.	Guidelines for Zero Schedule instructions to the Generating Units	<ul style="list-style-type: none">• In case of anticipated generation availability in surplus, the Distribution Licensee (DL) needs to optimize their cost of power procurement considering the contracted sources for the period of anticipated surplus,• DL may consider giving Zero Schedule to some of its contracted sources. This should be a conscious decision of the DL in consultation with Maharashtra State Load Despatch Centre (MSLDC) taking into account the demand supply position and transmission constraints.• If grid constraints prevent the Zero Scheduling of the unit with highest Variable Charge (VC) in the MOD stack, the unit with the next highest VC needs to be considered.• The DL must give the Generating Company 24 hours prior notice of the Zero Scheduling.• In case a particular unit is, in fact, required to be scheduled during the pre-declared Zero Scheduling period, the DL must intimate the Generating station at least 72 hours in advance for the Unit(s) to come on bar in cold start.• Zero Scheduling to be carried out by DL considering the roles and obligations under the corresponding PPAs• Additional cost implication in Variable Charges that arises on account of Zero Scheduling will not be allowed as pass through

Merit Order Dispatch (MOD): Issues & Guidelines (1/3)

	IDENTIFIED ISSUES	GUIDELINES
2.	Guidelines for Reserve Shut Down (RSD) of Generating Units by MSDLC	<ul style="list-style-type: none"> • A Reserve Margin equivalent to the contracted capacity of the largest unit of the Power Station, contracted by the Distribution Licensee needs to maintained. • The Reserve Shut Down (RSD) should be implemented for the capacity available in excess of the largest Unit contracted by the DL. • The RSD should be applied to Units with higher Variable Charges in the MOD stack, subject to grid conditions permitting the same.
3.	Periodicity and date of preparation of MOD stack	<ul style="list-style-type: none"> • Variable Charge of immediately preceding month and in case the Variable Charge (VC) of immediately month is no available, the average of the latest available VC for the preceding 3 months needs considered for preparation of the MOD stack. • SLDC to prepare the MOD stack by 15th of every month which will be effective from 16th of the month till 15th of subsequent month • The MOD Stack may be subsequently revised by MSLDC-OD on account of new source, revision in Variable Charges due to issuance of Tariff Order by CERC or SERC and impact of change in Law as per PPA
4.	Basis of preparation of MOD stack, including the variable charge to be considered	<ul style="list-style-type: none"> • DL need to submit data for variable charges of generating stations/units to MSLDC. • For Generating Stations (GS) whose tariff is being determined by the Commission under sec 62, the VC for MOD purposes shall be the Energy Charge plus the actual FSA. • For Central GS , the VC for MOD purposes shall be the landed cost at the State Periphery. • For PPAs entered under sec 63, the VC for MOD purposes shall be the Energy Charge plus impact of change in law. • For Intra State OA transactions above 50 MW, 60% of total tariff shall be considered as VC for MOD purpose.

Merit Order Dispatch (MOD): Issues & Guidelines (3/3)

	IDENTIFIED ISSUES	GUIDELINES
5.	Guidelines for operating the Generating Units	<ul style="list-style-type: none">• As a basic principle, MSLDC is required to finalize the despatch schedule based on least-cost principles.• DL should try to procure the highest possible capacity from the units permitted by the system, rather than scheduling the Units at Technical Minimum.
6.	Guidelines for capacity declaration by Generating units	<ul style="list-style-type: none">• Apart from the day ahead generation schedule, the Generating Company shall also provide the additional information regarding the fuel and water availability in the provided format.• In accordance with the MERC MYT Regulations 2015 provision which specifies the demonstration of Declared capacity by GS, MSLDC shall ask the GS to demonstrate the max DC of Generating unit for the particular time block.
7.	Identification of Must Run Stations, and guidelines for operating Hydro Stations	<ul style="list-style-type: none">• With significant generation capacity addition in the State, MSLDC needs to ensure that the intended purpose of Hydro Generating Stations is not defeated and indiscriminate use of Hydro power is avoided.
8.	Technical Minimum of Generating Units	<ul style="list-style-type: none">• Technical Minimum for operation in respect of a coal fired/gas fired/multi fuel based thermal generating unit connected to the STU shall be 55% of its installed capacity.

CERC Staff Paper on FGD

Norms for Consumption of Reagent (1/2)

The normative consumption of specific reagent for various technologies for reduction of emission of sulphur dioxide shall be as below:

(a) For Wet Limestone based Flue Gas De-sulphurisation (FGD) system

The specific limestone consumption (g/kWh) shall be worked out by following formula:

$$[0.85 \times K \times \text{SHR (kCal/kWh)} \times S (\%)] \times [\text{GCV (kCal/kg)} \times \text{LP} (\%)]$$

Where,

S = Sulphur content in percentage,

LP = Limestone Purity in percentage,

Provided that value of K shall be equivalent to $(35.2 \times \text{Design SO}_2 \text{ Removal Efficiency}/96\%)$ for units to comply with SO₂ emission norm of 100/200 mg/Nm³ or $(26.8 \times \text{Design SO}_2 \text{ Removal Efficiency}/73\%)$ for units to comply with SO₂ emission norm of 600 mg/Nm³;

Provided further that the limestone purity shall not be less than 85%.

CERC Staff Paper on FGD

Norms for Consumption of Reagent (2/2)

(b) For Lime Spray Dryer or Semi-dry Flue Gas Desulphurisation (FGD) system

The specific lime consumption shall be worked out based on minimum purity of lime (LP) as at 90% or more by applying formula $[6 \times 0.90 / PL (\%)]$ gm/kWh

(c) For Dry Sorbent Injection System (using sodium bicarbonate)

The specific consumption of sodium bicarbonate shall be 12 g per kWh at 100% purity

(d) For CFBC Technology (furnace injection) based generating station

The specific limestone consumption for CFBC based generating station (furnace injection) shall be computed with the following formula:

$[62.9 \times S(\%) \times SHR \text{ (kCal/kWh) } /GCV \text{ (kCal/kg) }] \times [0.85/ LP]$, Where

S = Sulphur content in percentage,

LP = Limestone Purity in percentage

(e) For Sea Water based Flue Gas Desulphurisation (FGD) system

The reagent used is sea water, therefore there is no requirement for any normative formulae for consumption of reagent.



CER's Inputs for Forum of Regulators (FOR)

December 7, 2020

Return on Equity and, LTDF and Power Procurement Planning

Anoop Singh

Professor, Dept. of Industrial and Management Engineering (IME), IIT Kanpur

Founder & Coordinator, Centre for Energy Regulation (CER) & Energy Analytics Lab (EAL)

<https://cer.iitk.ac.in/>

<https://eal.iitk.ac.in/>

Return on Equity

RoE – Summary Recommendations

- Equity Base
- Latest estimate suggested a reduction in RoE
- Differentiated RoE across G, T & D: Risks → $D > G > T$
- No Grossing-up of RoE required
- Fine-tuning of RoE incentives

MYT Framework - Return on Equity

- Guided by 'Section 61. (Tariff regulations)'
- MYT Regulations across ERCs provide for an RoE framework (with few states having adopted RoCE)

- $\text{RoE}_{\text{post-tax}} = \text{Rate of Return}_{\text{post-tax}} * \text{Equity Base}$

✓

Or,

- $\text{RoE}_{\text{post-tax}} = \{\text{Rate of Return}_{\text{pre-tax}} / (1-t)\} * \text{Equity Base}$

✓

where, t - effective tax rate/MAT, as applicable

- Existing approach

- $\text{RoE}_{\text{post-tax}} = \{\text{Rate of Return}_{\text{post-tax}} / (1-t)\} * \text{Equity Base}$

?

- The terminology used to identify RoE is 'post-tax', but it is subject to grossing up.

Equity Base - Return on Equity

CER Opinion

- Accumulated depreciation over and above the accumulated debt repayment (including repayment towards normative loan) should be used **to reduce the equity base** for allowable RoE as a portion of the risk capital of the investor is available as free cash flow and is no longer deployed in normal business operations.
- In case, such 'excess depreciation' is reinvested in the business, for example to finance working capital, this should attract the appropriate cost of funds as approved for such respective ARR element. However, reduction of equity base would still be applicable.
- The regulatory approach for reduction of equity base should be integral part of the regulatory framework in the power sector thus mitigating additional burden of tariff paid by the consumers .

Estimation of Rate Return on Equity (Contd.)

CER

- A recent study at CER, IITK using CAPM and multi-factor models, using a comprehensive data for over 125 infrastructure companies between 1998-2018, estimates the cost of equity for conventional generation sector **to range between 12.86-16.52%, on a post-tax basis.**
- Against the estimated post-tax cost of equity of 12.86% (using CAPM) and 16.52% (using Three-Factor Model).

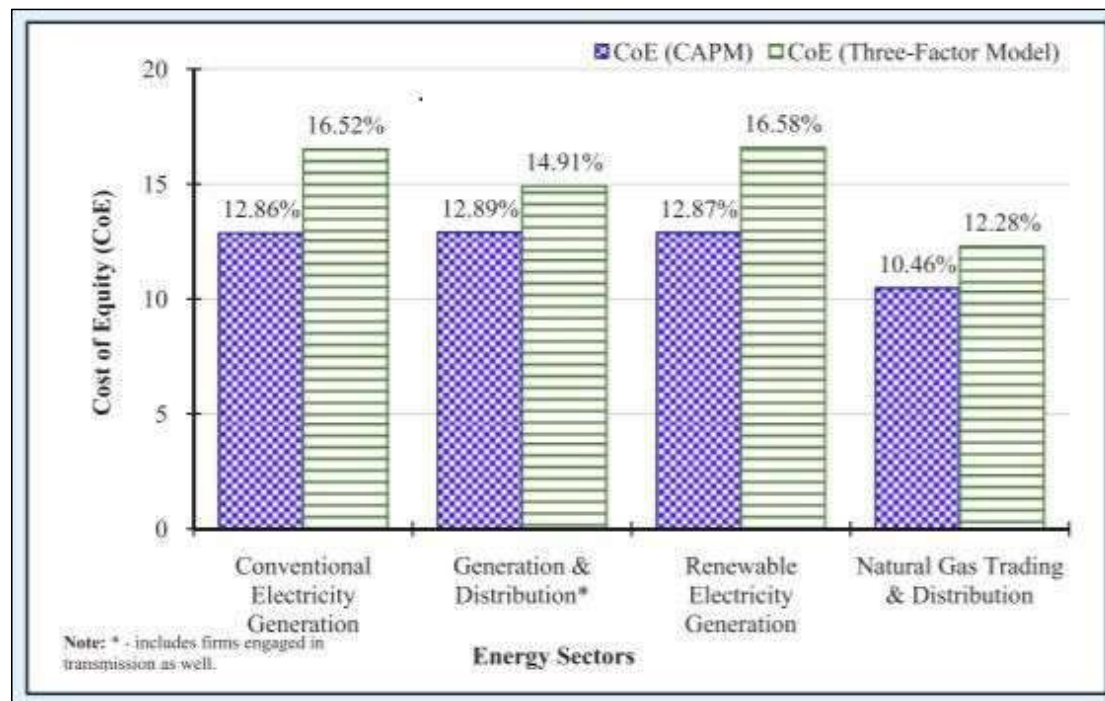

Refer: Regulatory Insights - Volume 03 Issue 01

(https://cer.iitk.ac.in/newsletters/regulatory_insights/Volume03_Issue01.pdf)

Estimation of Rate Return on Equity (Contd.)

- The cost on equity estimated by the CAPM approach is a **post-tax estimate**.

$$E(r_i) = r_i + \beta_i (r_m - r_f)$$

- A post-tax RoE that **should NOT be grossed up** by the rate of effective tax – as it is erroneous, and provides excess return.
- **A post tax RoE @ 15% works out to be post-tax RoE @ 19.12%** (after grossing up with 18.5% MAT plus 12% surcharge, and 4% cess for 2018-19).
- **A post tax RoE @ 15% works out to be post-tax RoE @ 18.17%** (after grossing up with 15% MAT plus 12% surcharge, and 4% cess for 2020-21).

Refer: Regulatory Insights - Volume 03 Issue 01

https://cer.iitk.ac.in/newsletters/regulatory_insights/Volume03_Issue01.pdf

Recommendations for RoE Framework

- Reduction in RoE
 - To be estimated (rather than calculated) on the basis appropriate capital asset pricing model
 - To take into account the relative risk across business segments i.e. Generation, transmission and distribution
- No grossing-up of RoE by effective income tax is required as the **estimated RoE is already on a post-tax basis.**
- **Reduction in 'equity base'** (to account for accumulated depreciation exceeding debt repayment)
- Implementable provisions, based on benefits to the system, for **additional return for ramping capability of power plants.**

IoWC – Definition of Working Capital

- Working capital definition (for generation) generally includes
 - Coal stock - 30 days or less (pit head) and 45 days or less (non-pit head)
 - Secondary fuel stock - 60 days or less;
 - O&M expenses – 1 month;
 - Receivables – 1 month of capacity charge & energy charge equivalent to NAPAF;
 - Maintenance spares @ 40% of R&M expenses or, @ 1% of opening GFA.
- Is there an instance of **over estimation of WC?**
- Fuel & transportation cost (in part or full) and a part of R&M expenses (incl spares) are payable in advance. **The remaining components of working capital** (like salary and wages, A&G expenses and remaining part of R&M) are **payable at the end of the month or later.** (See Fig.)
- **In the above example, the anomaly can be addressed by excluding 1 month O&M expenses from the WC definition, and including a part of other expenditure heads deemed to be incurred in advance.**
- Since PLF of plants (esp high VC ones) are declining much below their NAPAF, **receivables** equivalent to energy charge should be computed **on the basis of average PLF of the past year / past three months instead of NAPAF.**
- A similar approach should be adopted for transmission and distribution.

Interest on Working Capital

CER Opinion

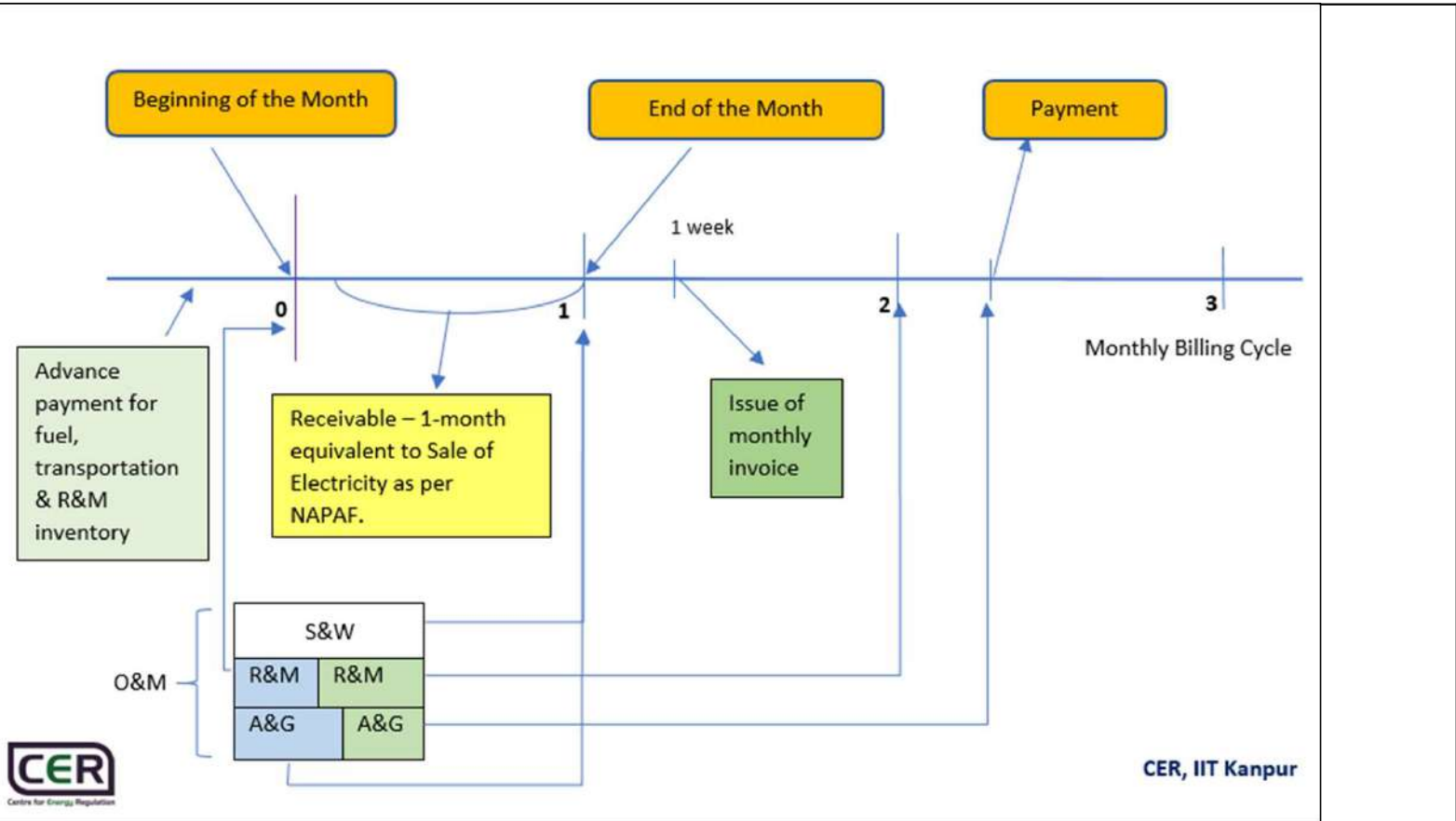

Return on Equity (Rs./kWh)

RoE – Himachal Pradesh

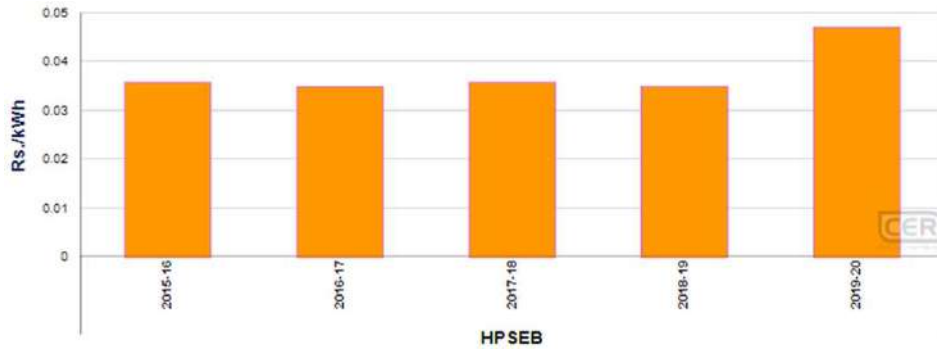

RoE – Uttarakhand

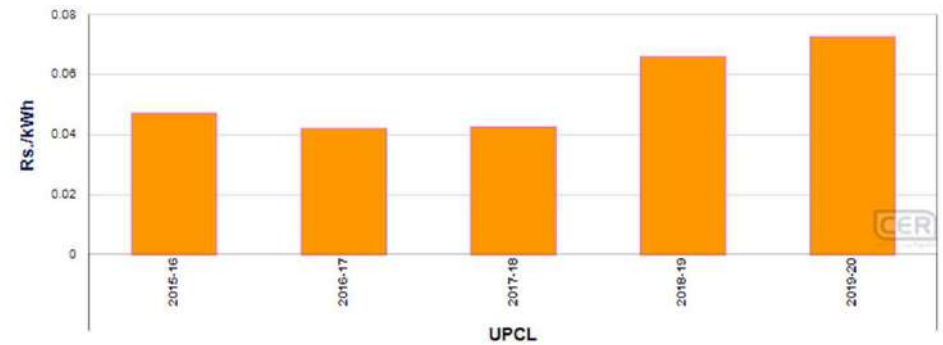

RoE – Gujarat

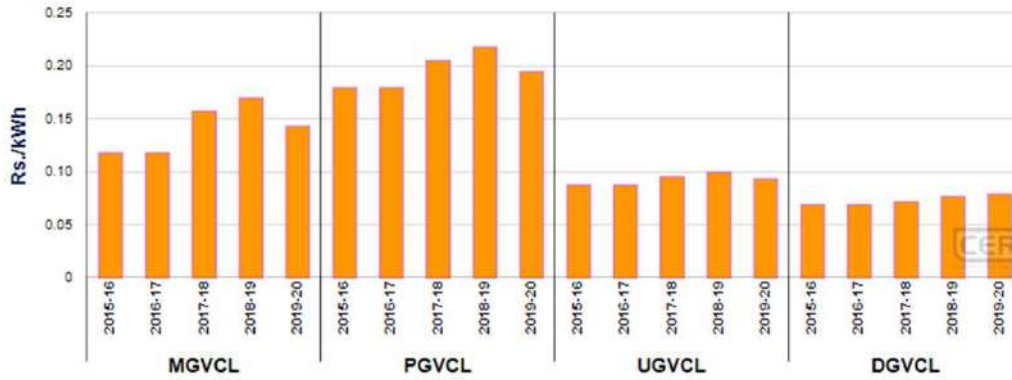

RoE – Odisha

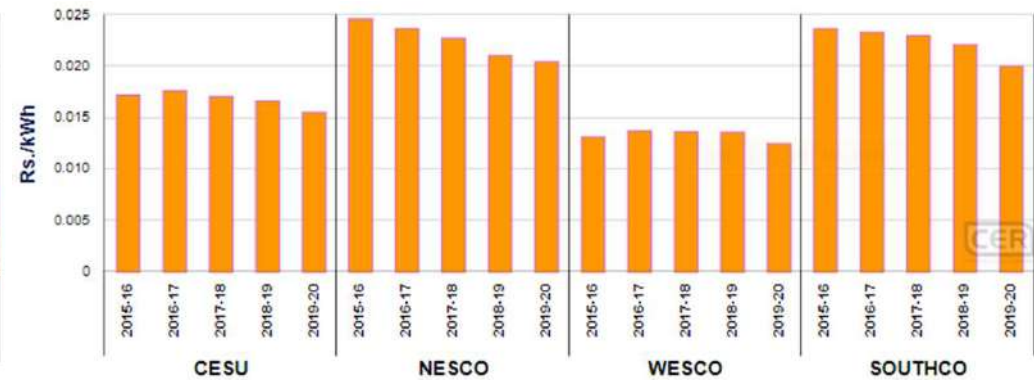

Interest on Working Capital (Rs./kWh)

IoWC - Punjab



IoWC – Himachal Pradesh

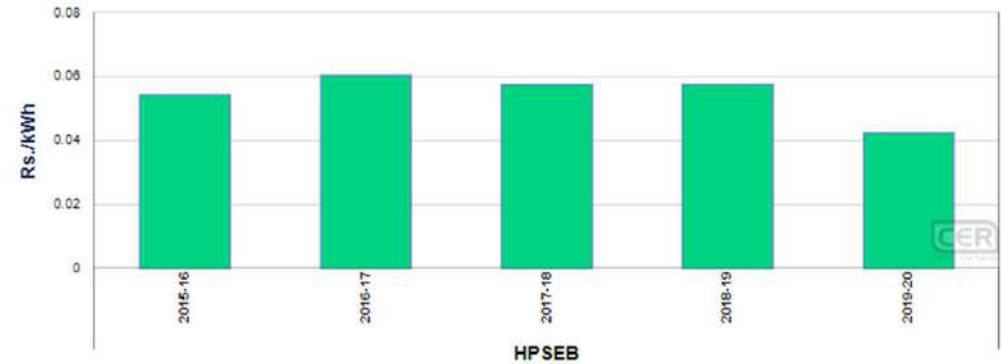

IoWC – Uttar Pradesh

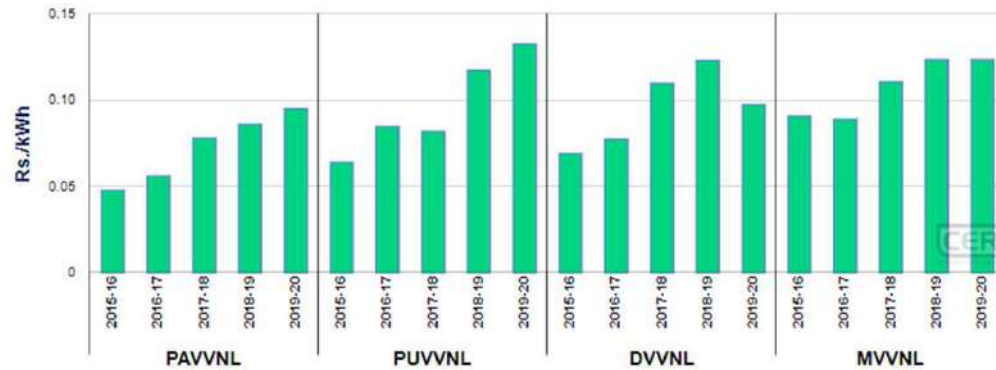

IoWC - Maharashtra

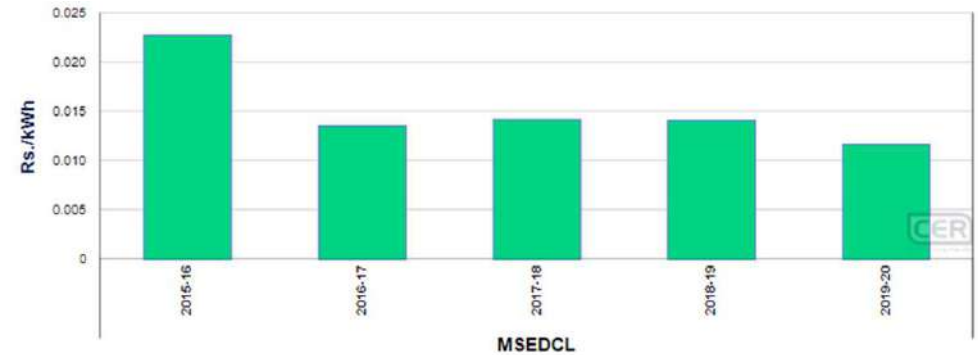

Components of ARR – Growth Across Time

Average ARR and its Components - UP

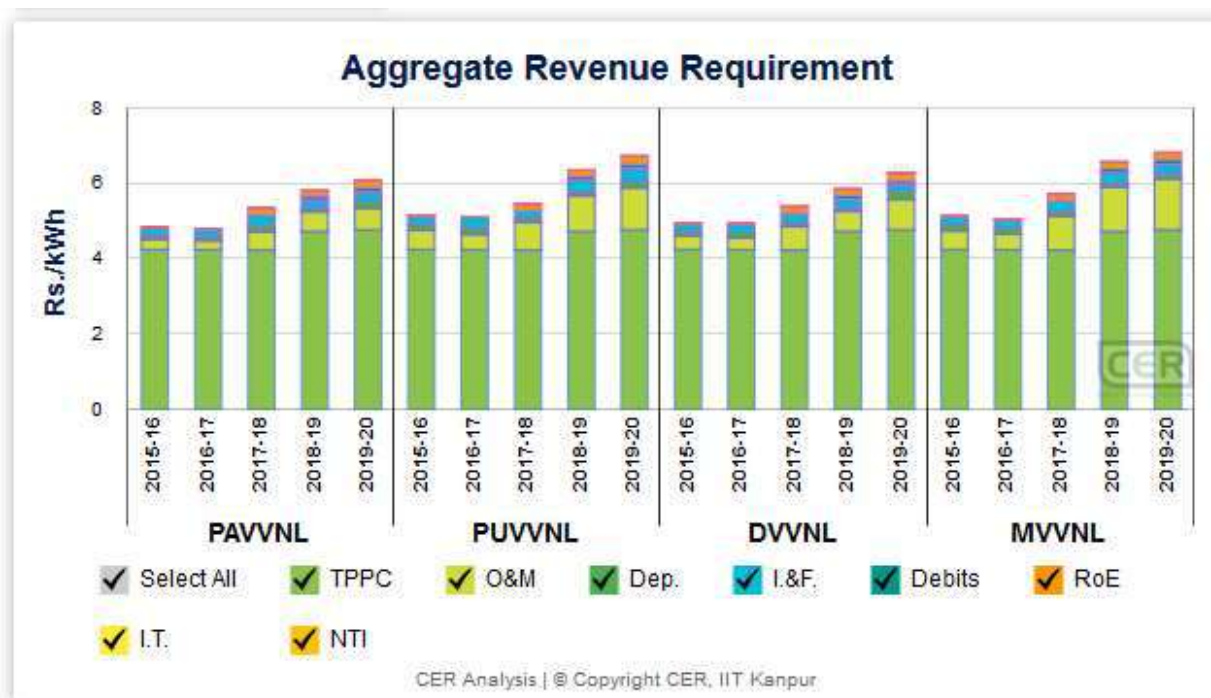

So: CER's Regulatory Database

Per unit O& M cost and its Components - UP

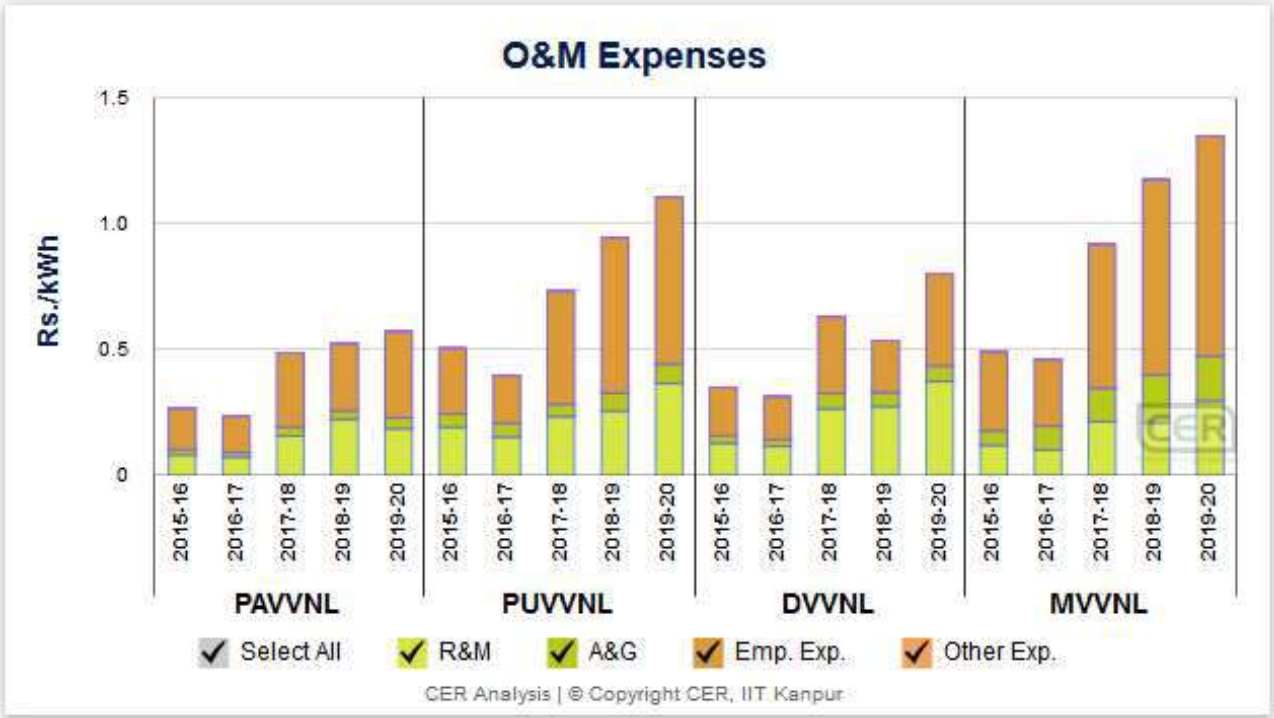

So: CER’s Regulatory Database

Average ARR and its Components - Rajasthan

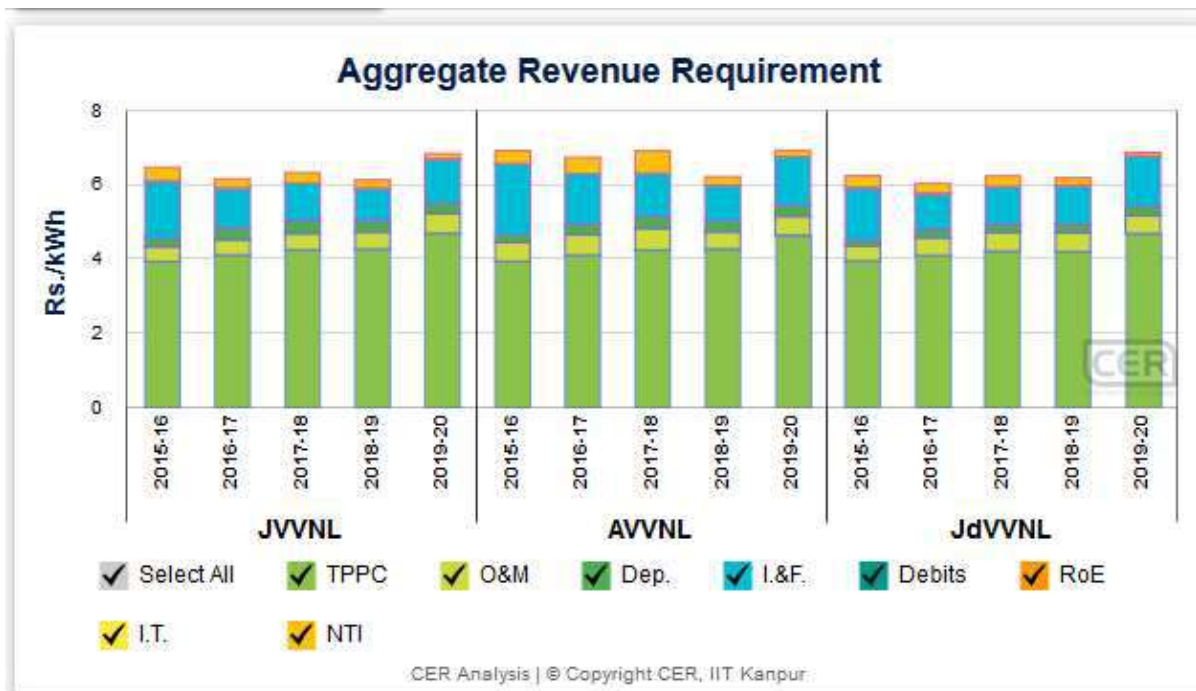

So: CER's Regulatory Database

Per unit O& M cost and its Components - Rajasthan

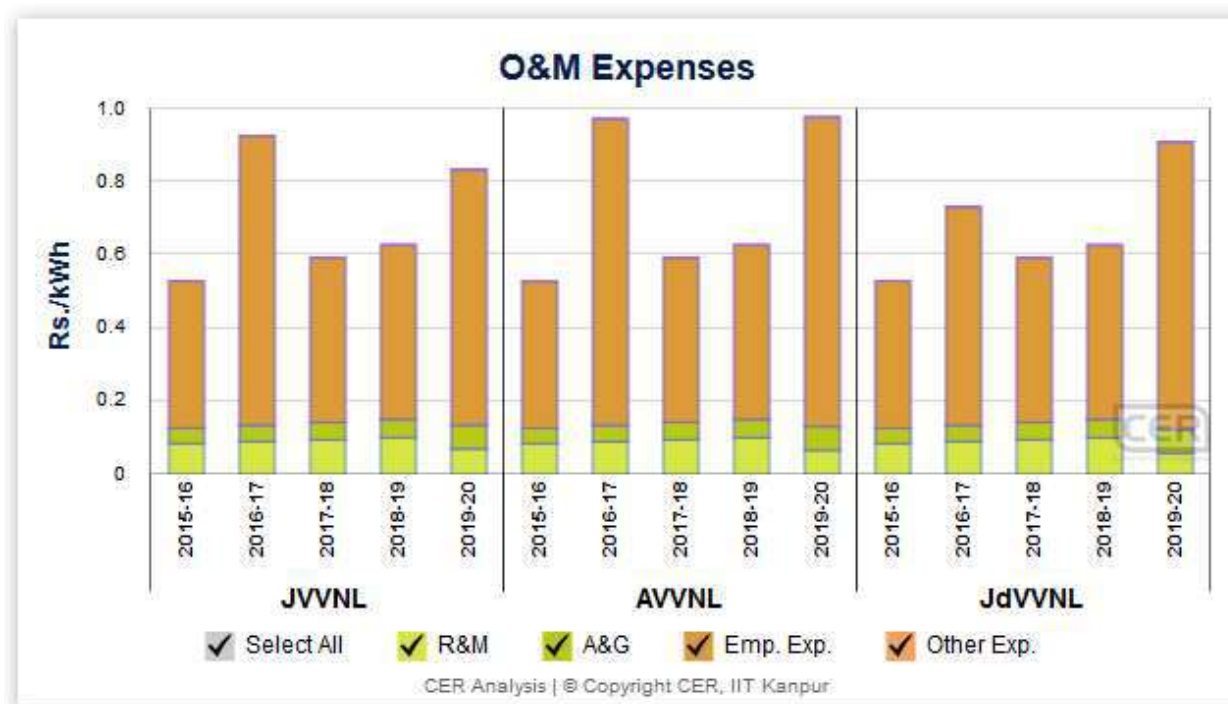

So: CER's Regulatory Database

Average ARR and its Components - Haryana

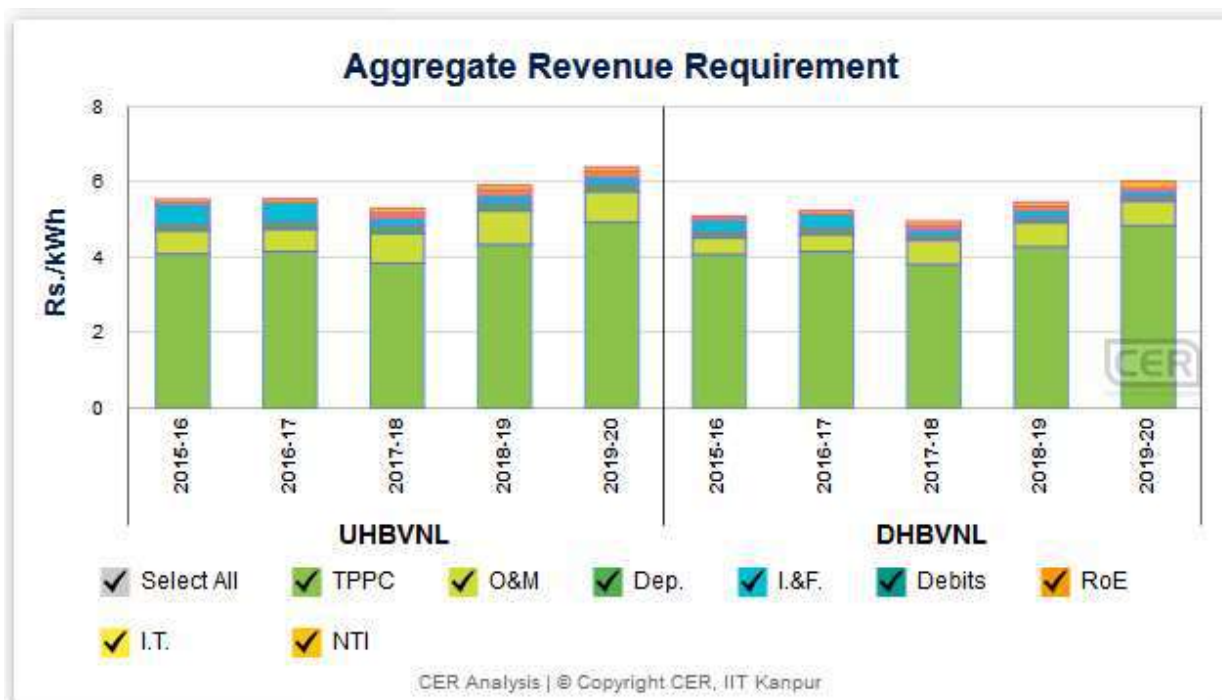

So: CER's Regulatory Database

Per unit O& M cost and its Components - Haryana

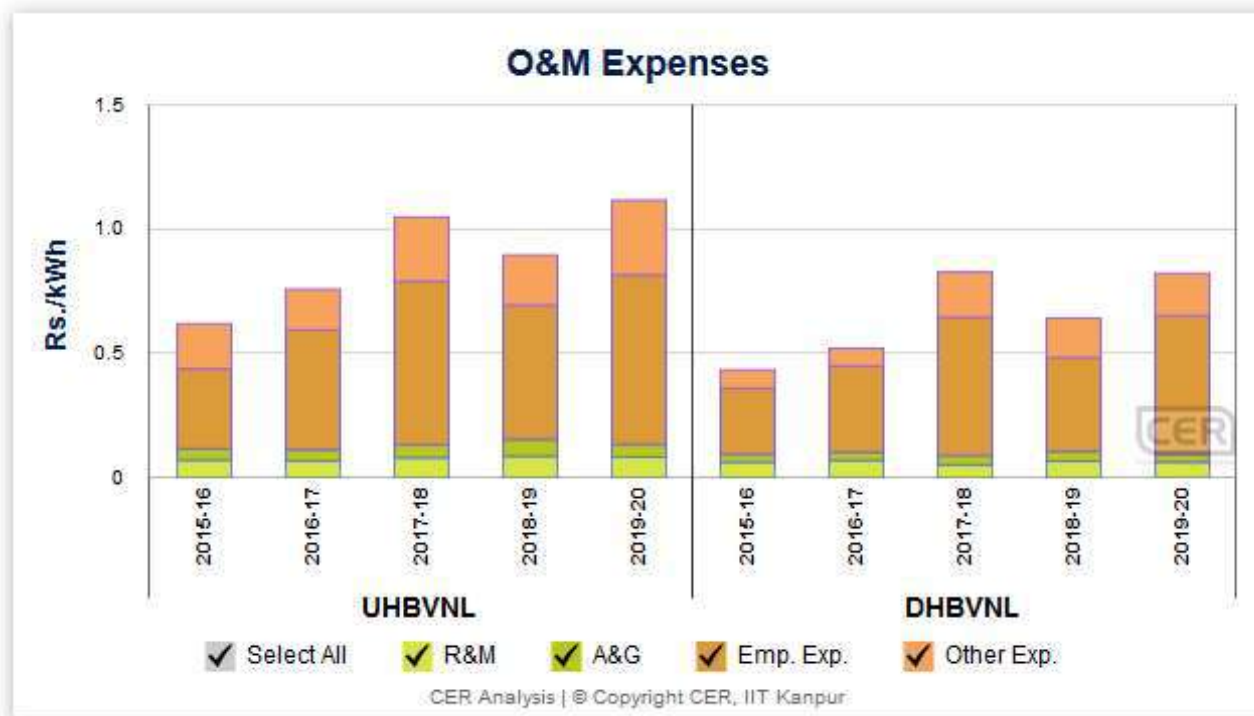

So: CER's Regulatory Database

Approved - Fixed and Variable Charges of PP

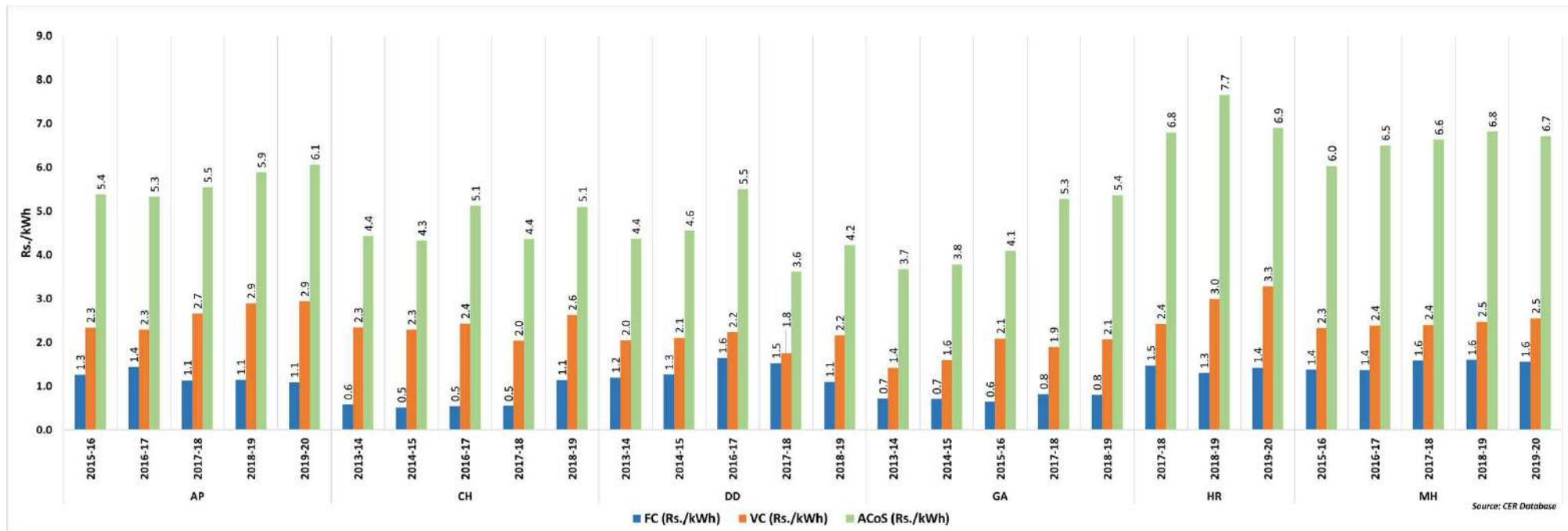

Approved - Fixed and Variable Charges of PP

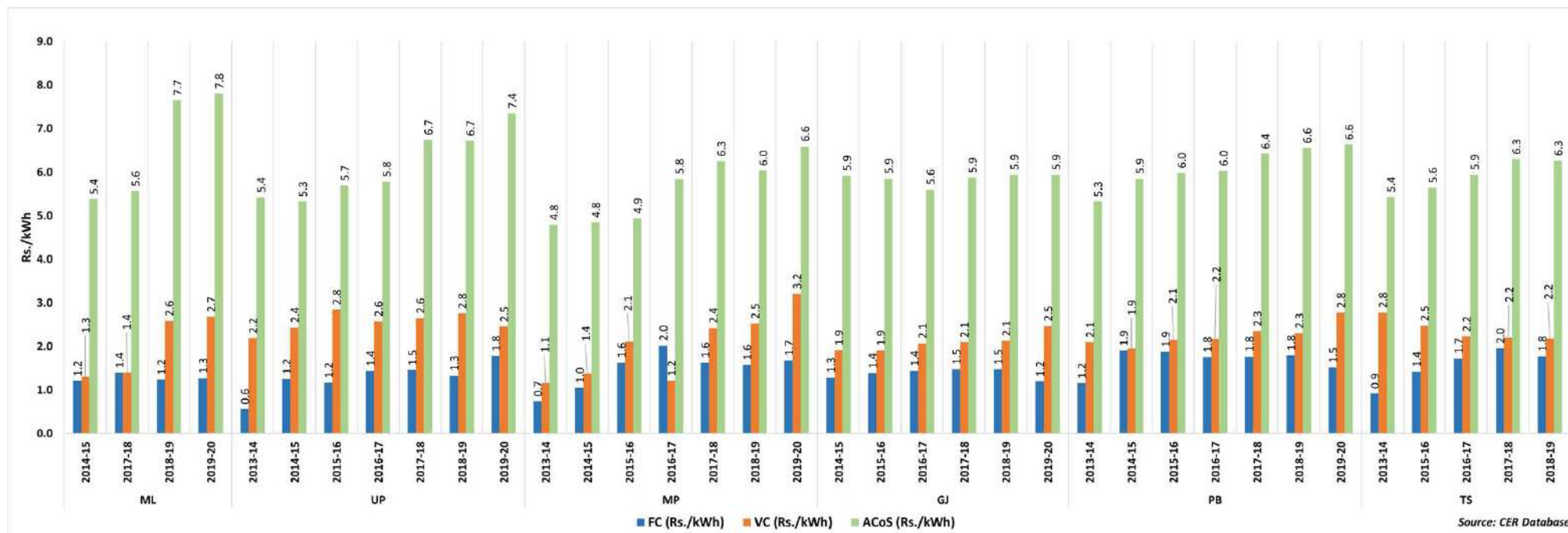

Source: CER Database

Approved - Fixed and Variable Cost of PP

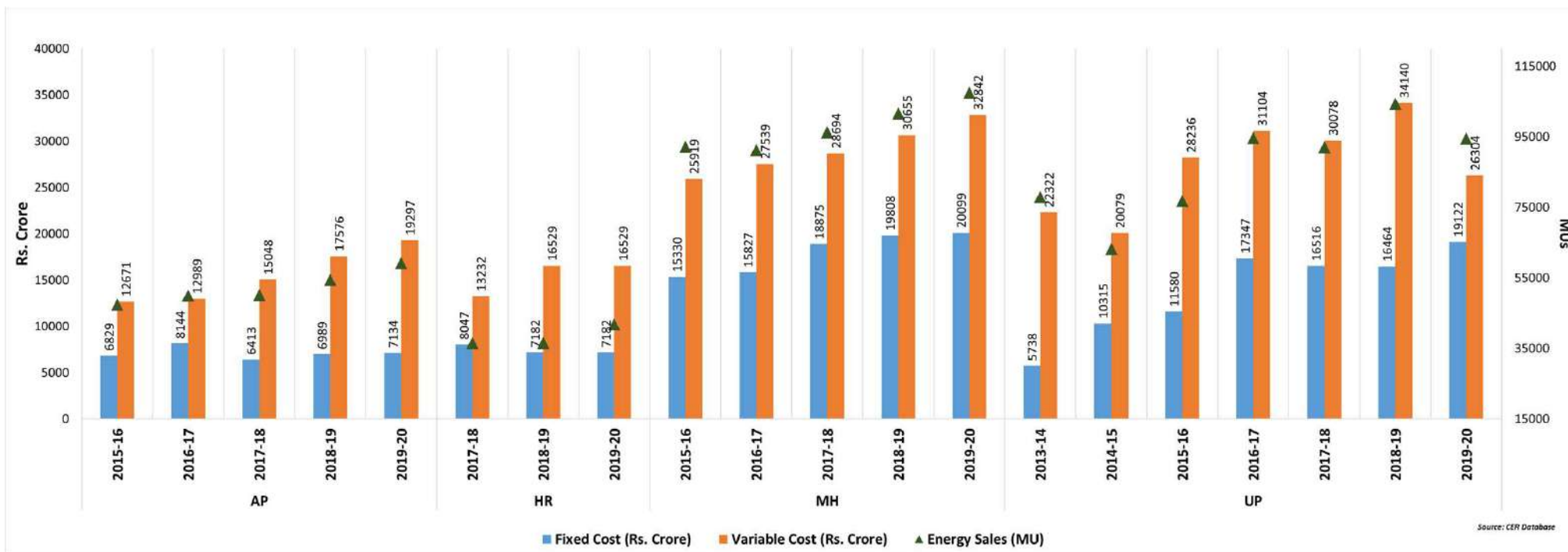

Approved - Fixed and Variable Cost of PP

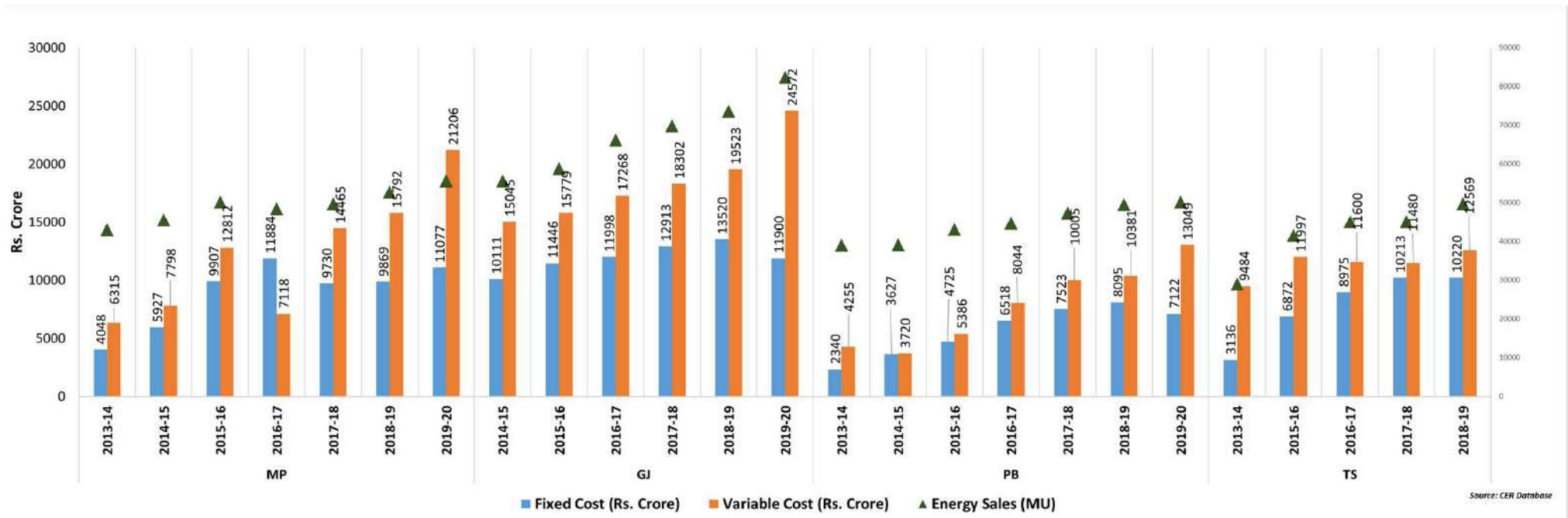

Impact of various parameters on ACoS – Andhra Pradesh FY 16 to FY 21

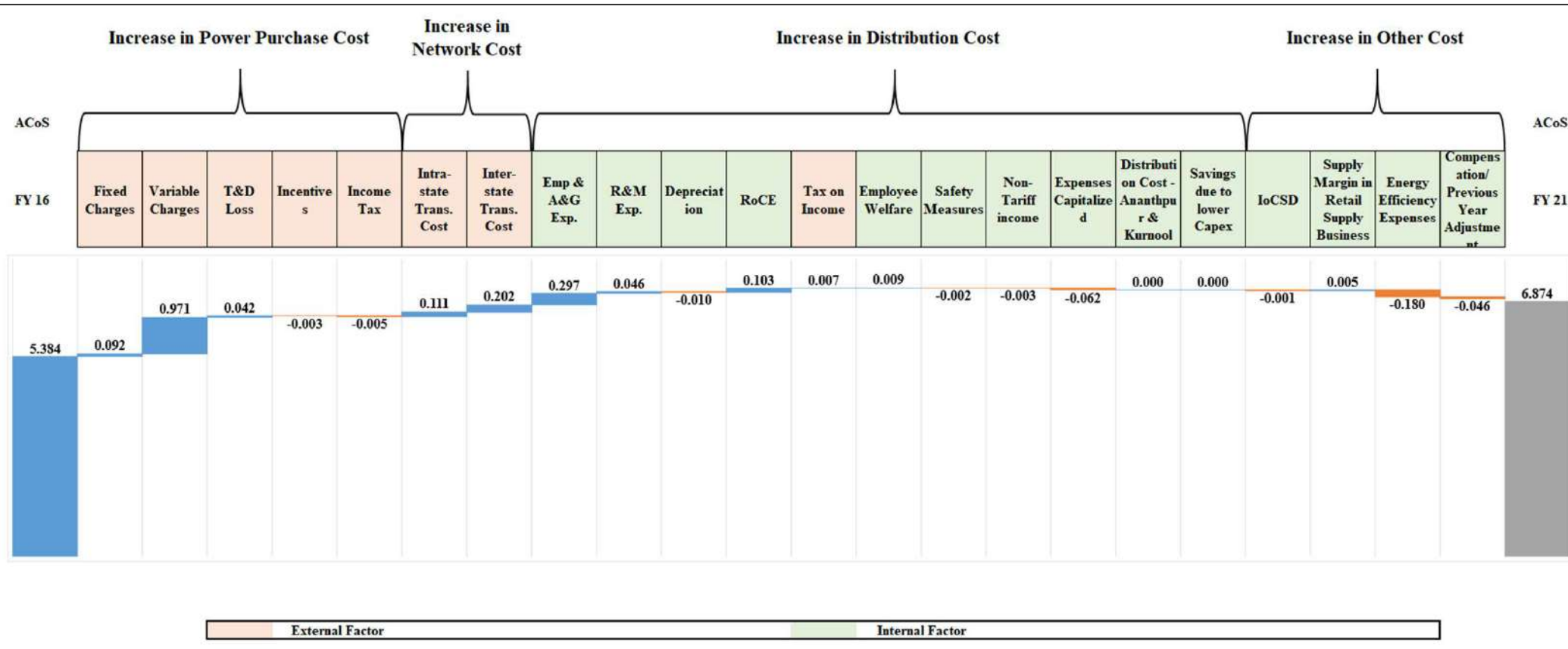

Impact of various parameters on ACoS – Gujarat FY 15 to FY 21

Increase in Power Purchase cost			Transmission cost		Increase in O&M Cost				Increase in CAPEX related costs of DISCOMs				Increase in other costs			ACoS	
Fixed Charges	Variable Charges	T&D Losses	Interstate Charge (PGCIL)	Intrastate Charge (GUVNL + GETCO + SLDC)	Employee Expense	A&G Expense	R&M Expense	Capitalization	Interest & Finance charges on CAPEX loans	Depreciation	RoE	Interest on working capital	Prov for bad and doubtful debts	Prov for tax/ Tax Paid	Non-Tariff Income	Revenue Gap	ACoS
FY 15																	FY 21

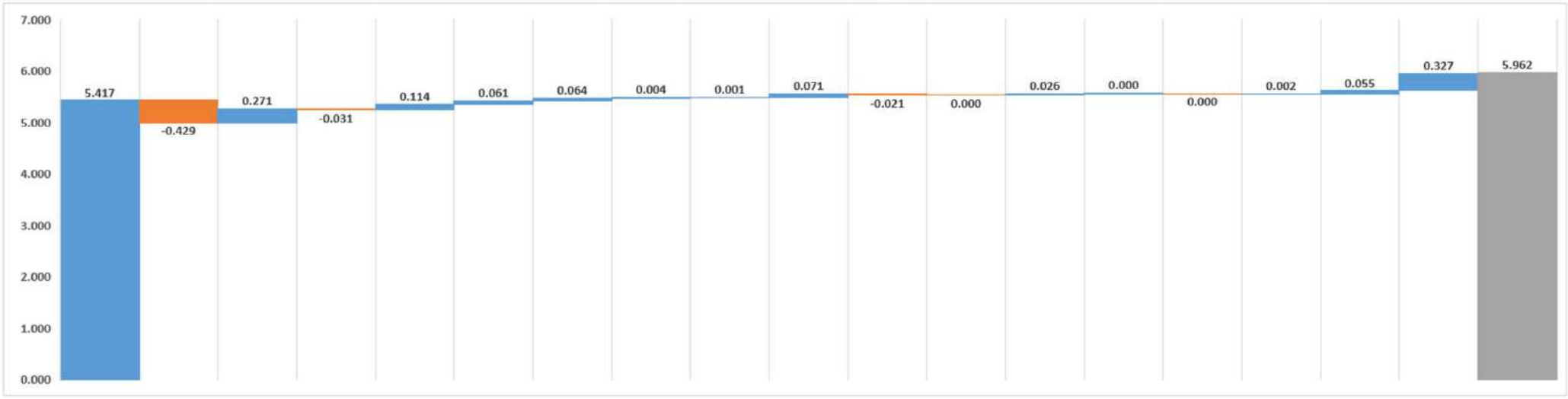

External Factor
Partially Internal Factor
Internal Factor
To be decided on case to case basis

Cost of Power Procurement: LT Demand Forecasting and Power Procurement Planning

CER's – 'Regulatory Framework for Long-term Demand Forecasting and Power Procurement Planning'

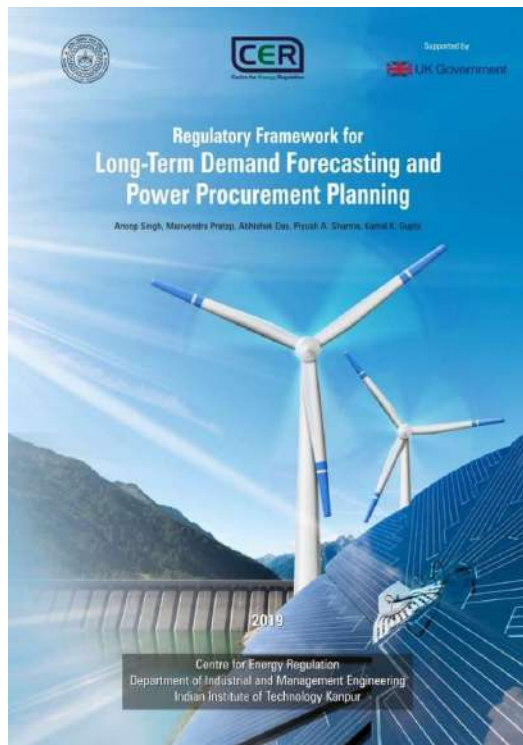

<https://cer.iitk.ac.in/publications>

conclude that some of the EPS had overestimated the demand for electricity. As shown in Figures 5 and 6 and Tables 2 and 3, the 18th EPS had significantly overestimated the electricity demand, actual demand growth was much lower than expected. Therefore, demand projections in the 19th EPS were accordingly reduced by over 23 percent based on a lower estimated demand growth. The forecasted values of demand in the 19th EPS were closer to the actual values during the initial years, but there were significant deviations in the subsequent years. Compound Average Growth Rate (CAGR) of the projected electrical energy requirement during 2010-11 to 2015-16 was 7.62 percent, whereas the actual CAGR for the same period was 3.23 percent. Moreover, the CAGR of peak demand for 2010-11 to 2015-16 was actually 4.63 percent against the predicted value of 8.50 percent.

Table 2. Comparison of electricity demand projections in 18th and 19th EPS Reports

Year	Actual Demand (MW)	Peak Electricity Demand				
		18 th EPS Projections (MW)	Overestimated Demand in 18 th EPS (MW)	19 th EPS Projections (MW)	Overestimated Demand in 19 th EPS (MW)	Difference between 18 th and 19 th EPS (MW)
(1)	(2)	(3)	(4) = (2)-(3)	(5)	(6) = (2)-(5)	(7) = (5)-(3)
2010-11	1,22,287	1,22,287	0			
2011-12	1,30,006	1,32,885	2,879			
2012-13	1,35,453	1,43,267	8,814			
2013-14	1,35,918	1,54,268	20,290			
2014-15	1,48,166	1,69,491	21,325			
2015-16	1,53,366	1,83,902	30,536			
2016-17	1,55,542	1,99,540	19,998	1,81,834	2,292	57,706
2017-18	1,64,066	2,14,093	50,027	1,76,897	12,831	57,196
2018-21	2,43,470			2,25,731		57,739
2026-27	4,00,703			2,98,774		1,01,931

Source: 18th and 19th Electric Power Survey of India, CEA (1-5)

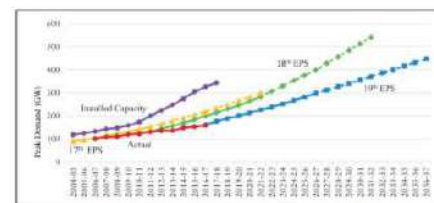

Figure 5. Historical projections of annual peak electricity demand (all India)

Source: 17th, 18th and 19th Electric Power Survey of India, CEA (1-5), Load Generation Database Reports (LGR), (2010-11-19)

Recommendations

Based on the projected electricity demand, power procurement portfolio till 2026-27 was recommended for the realistic scenario, considering policy targets for RE and DSM, under two scenarios – with and without short-term power procurement – as represented in Figures 26 and 27 respectively.

Figure 26. Realistic growth - Policy target (with Short-term Power Procurement)

Figure 27. Realistic growth - Policy target (without Short-term Power Procurement)

A number of alternate strategies included floating the candidate plants to maintain the overall private and social costs. Based on the findings of the study, estimating significantly higher economic benefits for the full-fledged optimal procurement strategy it was suggested that the distribution utilities should undertake such an exercise more frequently.

Copyright © IIT Kanpur

Historical projections of annual peak electricity demand (All India)

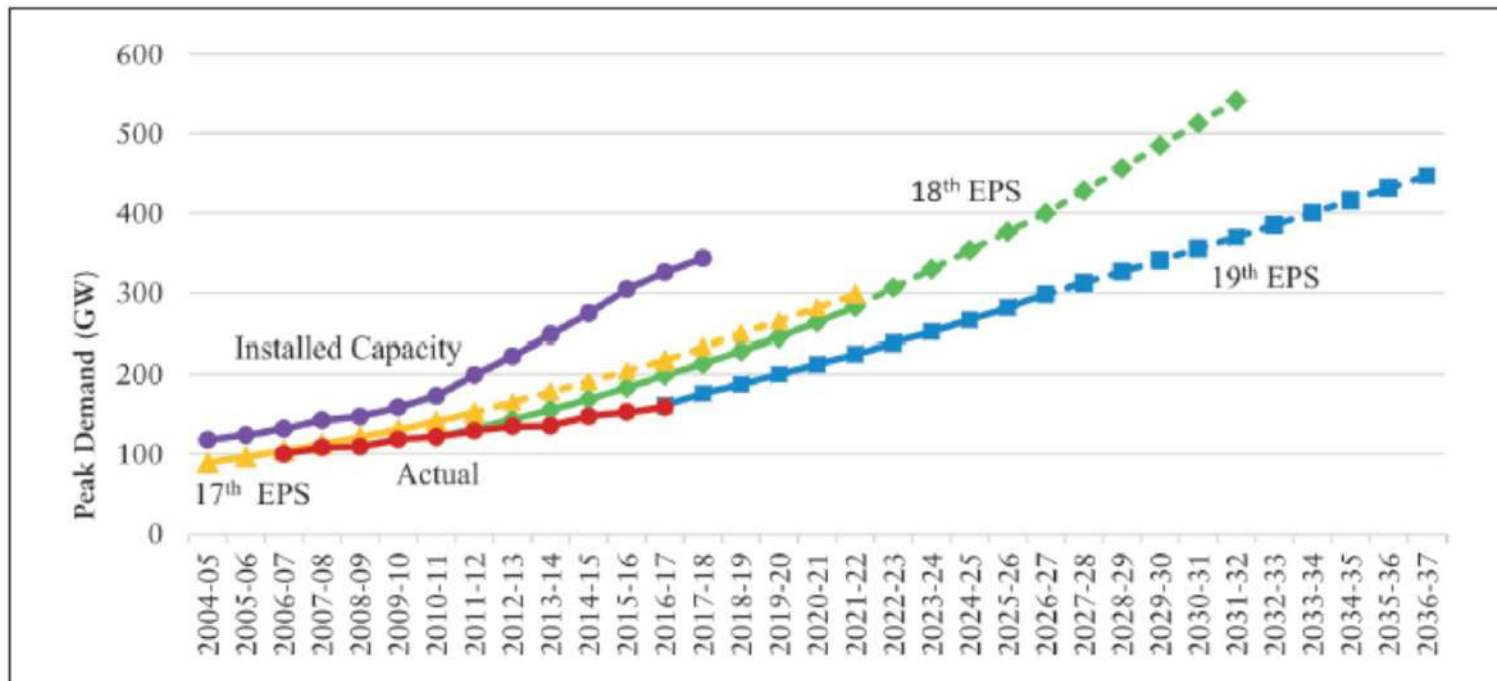

So: Singh et al. (2019), *Regulatory Framework for Long-Term Demand Forecasting and Power Procurement Planning*, Centre for Energy Regulation, IIT Kanpur (Book ISBN: 978-93-5321-969-7); <https://cer.iitk.ac.in/publications>

Actual peak demand vs. projections (Maharashtra)

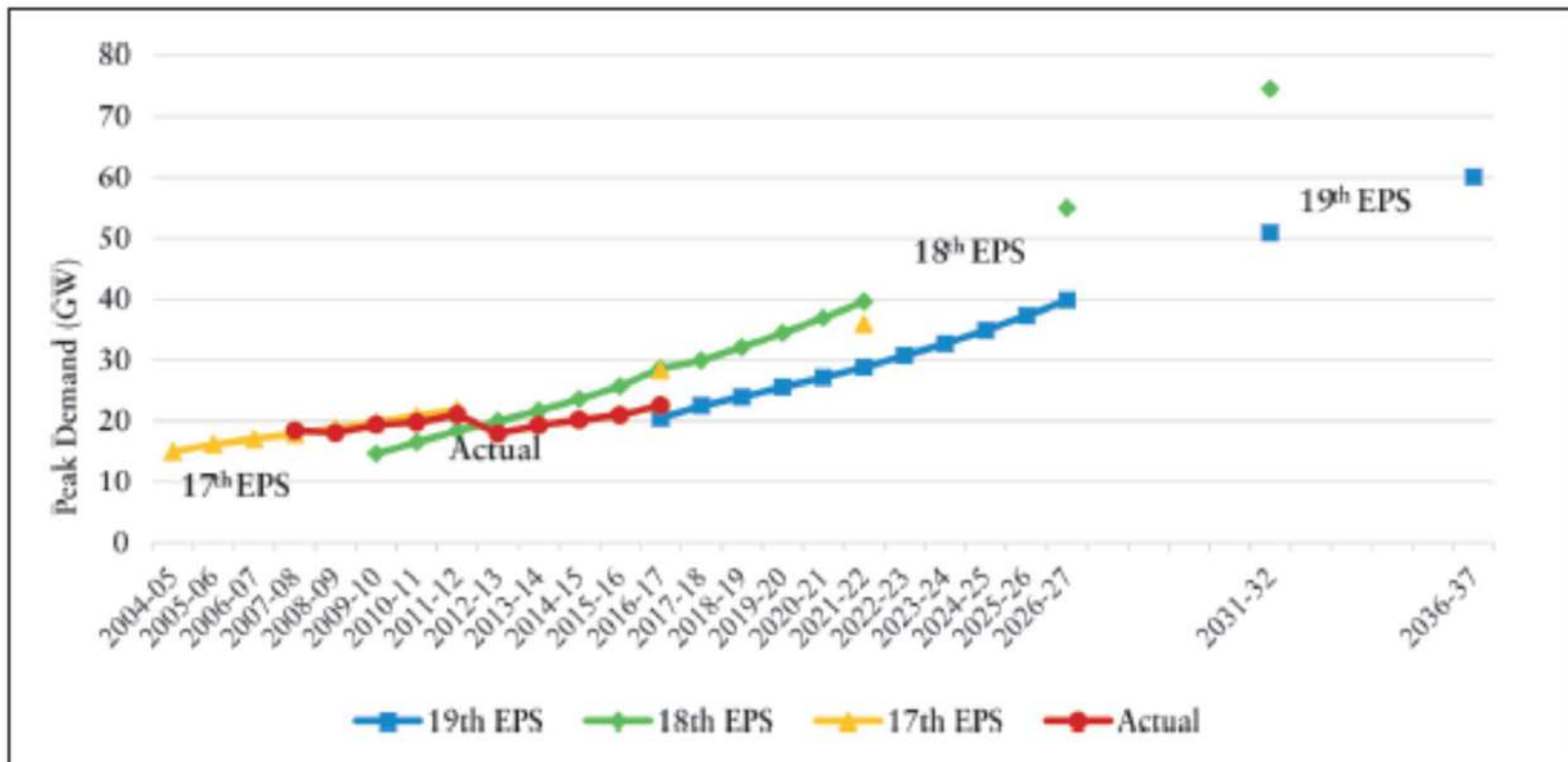

Actual peak demand vs. projections (NCT Delhi)

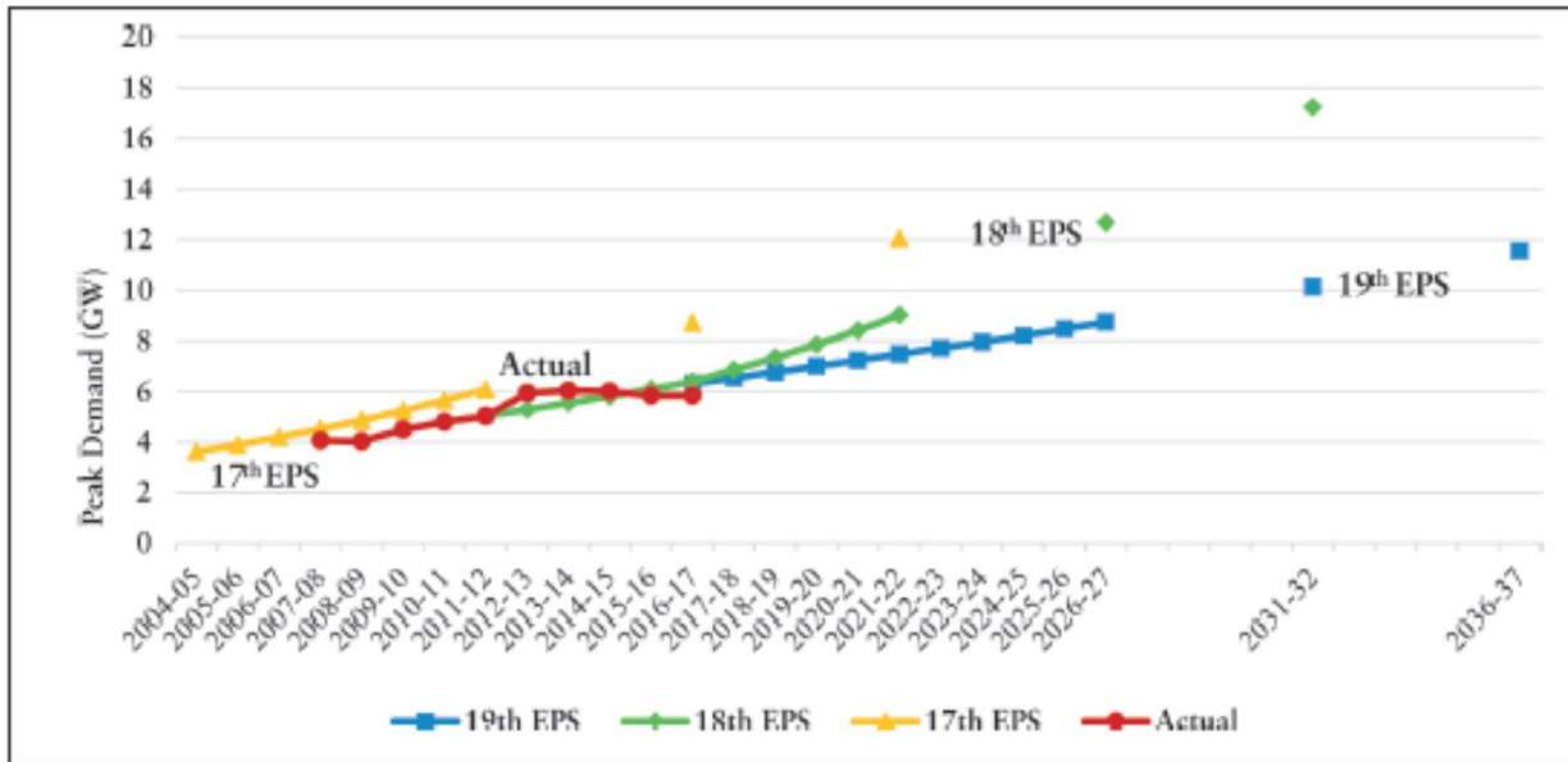

Actual peak demand vs. projections (UP)

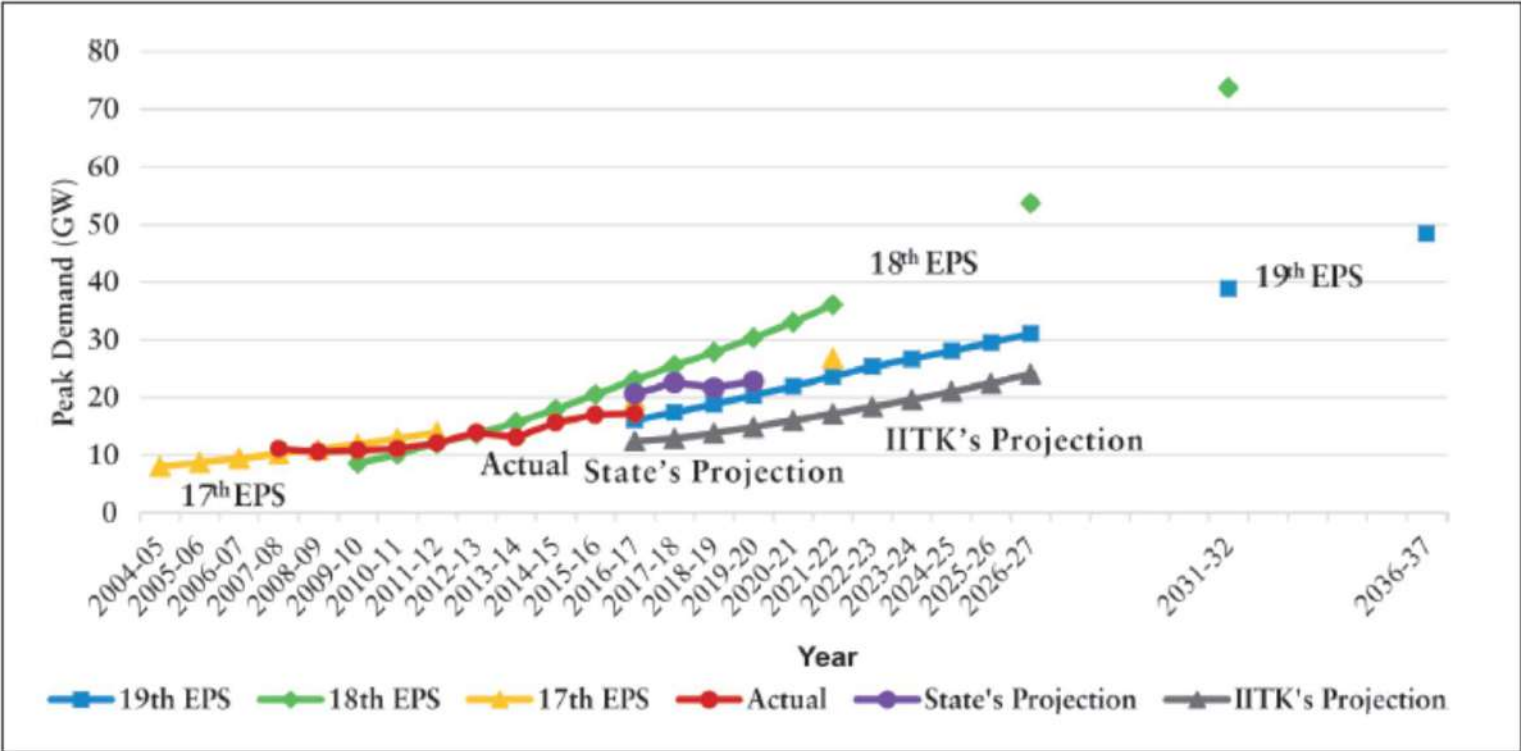

Actual energy demand vs. projections (UP)

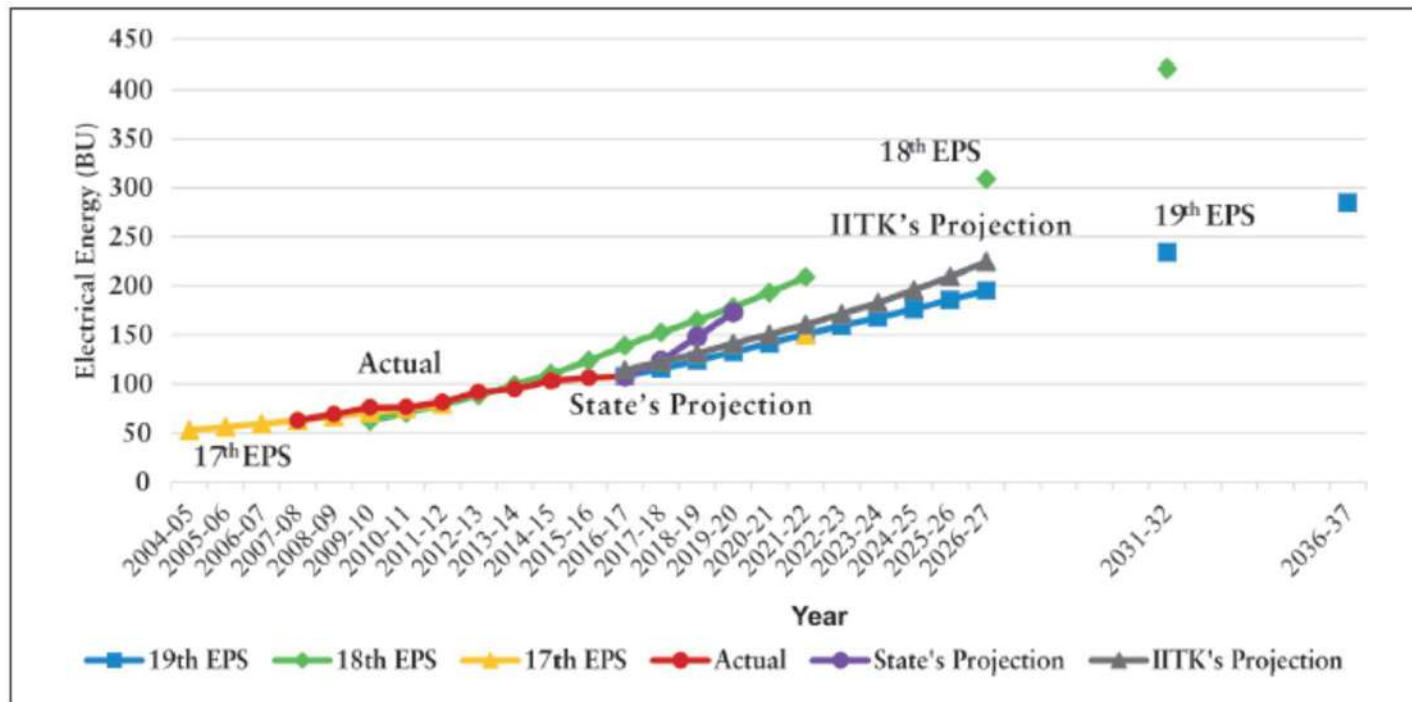

Cost of Power Procurement – Key Recommendations

- Power Procurement to be considered ‘controllable/ partially controllable’ over medium- to long-term.
- Separate Regulatory Process for ‘Demand Forecasting and Power Procurement Planning’
- MT & LT Demand Forecasting and Power Procurement Planning every 3-5 year with annual revision
- Explore flexibility in historical PPAs
- Strict Adherence to MoD, with public disclosure for deviations with reasons thereof.

Regulatory Approach to Generation Tariff

- Trajectory of norms for SHR reduction
- Aux Consumption – Non-revision of norms
- Investment approval to meet the above targets, based on a cost-benefit analysis.
- Normative cost recovery should be linked to incentives for achieving efficiency targets.

Norms for operation for Thermal Generating Stations

SHR (kCal/kWh)

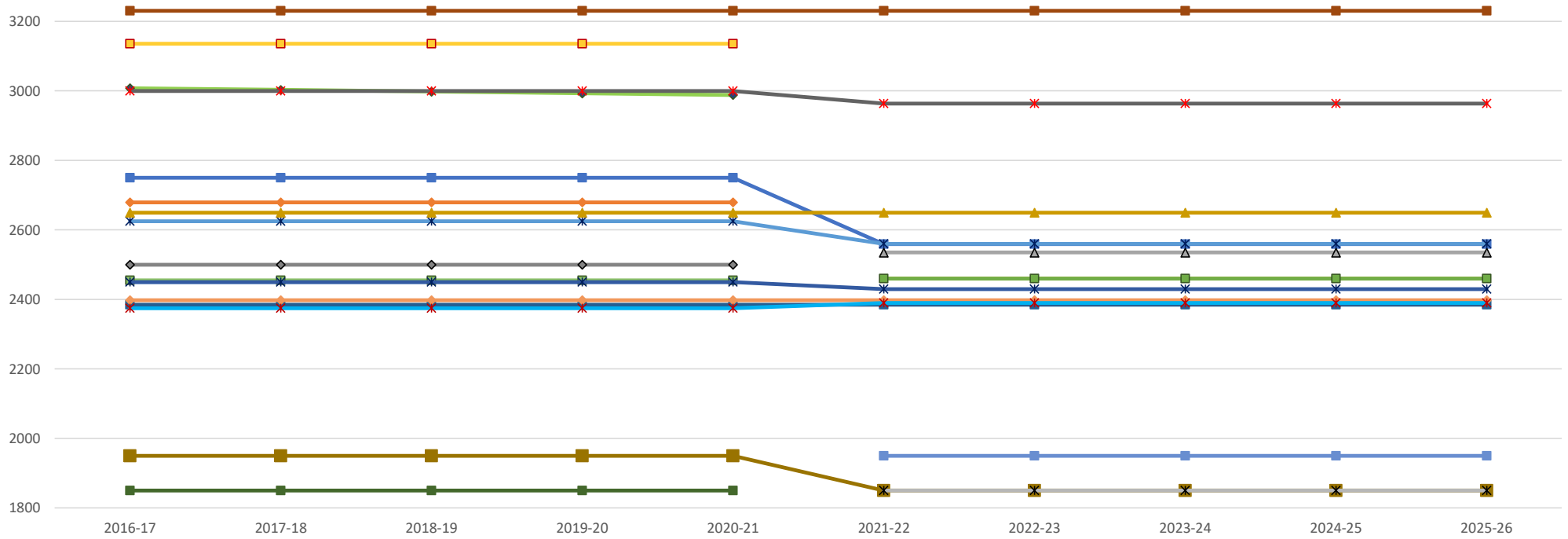

- GERC UkaiTPS (Unit 1- 5)
- GERC GandhinagarTPS (Unit 1- 4)
- GERC GandhinagarTPS (Unit 5)
- GERC GandhinagarTPS (Unit 3- 4)
- GERC WanakboriTPS (Unit 1-6)
- GERC WanakboriTPS (Unit 7)
- GERC SikkaTPS
- GERC Kutch Lignite (Unit 1-3)
- GERC Kutch Lignite (Unit 4)
- GERC DhuvaranCCPP - 2
- GERC DhuvaranCCPP-1
- GERC Sikka 3 & 4
- GERC Utran Extension
- GERC Sabarmati 'C'
- GERC Sabarmati 'D'
- GERC Sabarmati 'E' & 'F'
- CSERC 200/210/250 MW
- CSERC 300/500 MW
- CSERC DSPM
- CSERC HTPS

Copyright © IIT Kanpur



Norms for operation for Thermal Generating Stations

AUX (%)

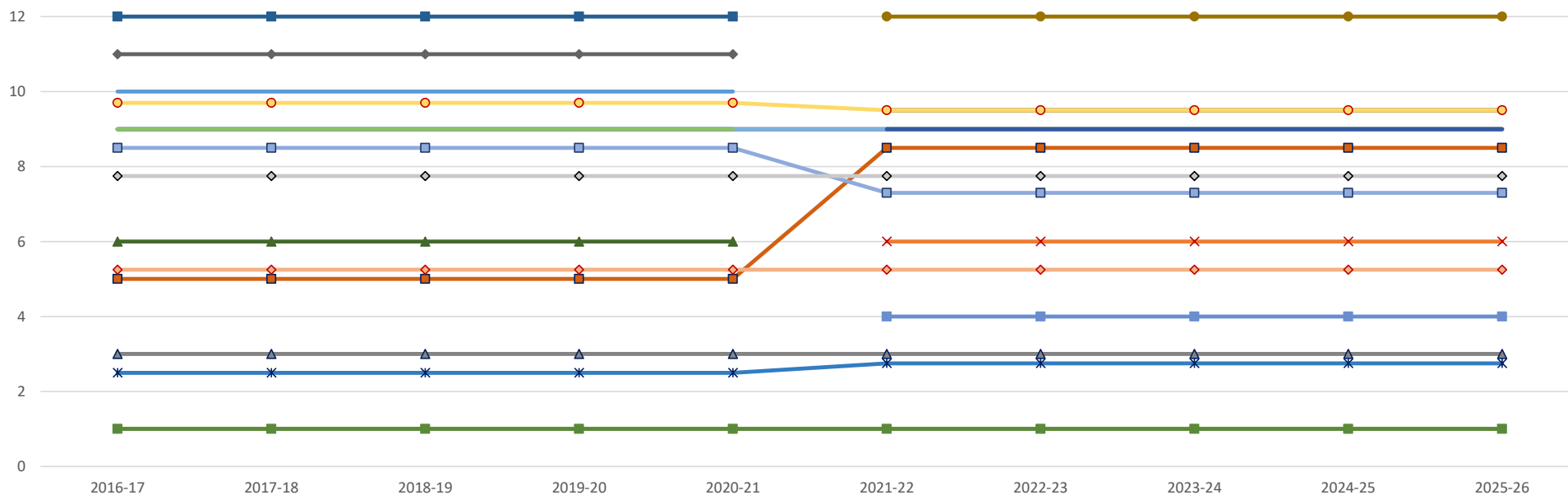

- GERC UkaiTPS (Unit 3- 5)
- GERC GandhinagarTPS (Unit 5)
- GERC Kutch Lignite (Unit 1-4)
- GERC Utran Extension
- GERC Combined cycle_Existing
- CSERC 300/500 MW and above SDBFP
- GERC UkaiTPS (Unit 6)
- GERC WanakboriTPS (Unit 1-6)
- GERC Ukai-6
- GERC Sikka 3 & 4
- GERC Open cycle_existing
- CSERC 300/500 MW and above EDBFP
- GERC UkaiTPS (Unit 1- 5)
- GERC GandhinagarTPS (Unit 3- 4)
- GERC GandhinagarTPS (Unit 1- 4)
- GERC WanakboriTPS (Unit 7)
- GERC DhuvaranCCPP-1
- GERC Sabarmati C
- GERC Sabarmati 'D' and 'F'
- GERC Sabarmati E
- GERC SikkaTPS
- GERC Kutch Lignite (Unit 3-4)
- GERC DhuvaranCCPP-2
- GERC DhuvaranCCPP-3
- GERC Open cycle_New
- CSERC 200 MW series
- GERC Combined Cycle_New
- CSERC HTPS

Copyright © IIT Kanpur

Fuel Supply Options – Key Suggestions

- Post coal sector liberalisation - Generating companies to explore alternate coal supply based on demonstrated cost reduction and improvement in GCV received.
- Channelise Clean Energy Cess to power sector - for RE/clean energy development and, to fund investment for improving efficiency and flexibility of thermal generating assets.

THANK YOU



Centre for Energy Regulation

cer.iitk.ac.in

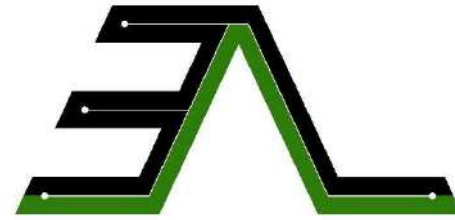

ENERGY ANALYTICS LAB

eal.iitk.ac.in

Centre for Energy Regulation (CER)

cer.iitk.ac.in

Newsletter : Regulatory Insights

CER Blog

Issue 04 Volume 02 April, 2020



REGULATORY INSIGHTS



Regulatory Outlook

- CERC Determination of Forbearance Price and Floor Price for the REC Framework 2
- APERC Terms and Conditions of Open Access Second Amendment Regulation, 2020 2
- CERC Tariff Framework for Procurement of Power by DISCOM and Others from Solar Projects and Other Commercial Sources 3
- HERC Guidelines for certifying or refusing to certify non-availability to Transmission/Distribution system or Unscheduled Load Shedding 5
- MERC (State Grid Code) Regulations, 2020 (Draft) 6
- TNERC Consultative Paper for Procurement (Solar and Wind Power) by DISCOM and related issues 6
- COVID-19 Impact on the Indian Power Sector 10

ERC Tracker

- Regulatory Updates 11
- Tariff Orders 14
- Regulations 15

CER News

- 13th Capacity Building Programme (CBP) for Officers of Electricity Regulatory Commissions 16
- CER Blog 16
- Free Registration at cer.lik.ac.in 16

Access online



cer.lik.ac.in/news_letter

Founder & Coordinator, Centre for Energy Regulation

The Centre is hosted in the Department of Industrial and Management Engineering, IIT Kanpur and is seed funded by Government of United Kingdom through a project titled 'Supporting Structural Reforms in the Indian Power Sector' under Power Sector Reforms (PSR) programme.



Centre for Energy Regulation (CER), Department of Industrial and Management Engineering, Indian Institute of Technology Kanpur, Kanpur - 208016 (India)

© CER, IIT Kanpur

Issue 03 Volume 02 January, 2020



REGULATORY INSIGHTS



Regulatory Outlook

- MoP: Pre-Payment in the Entire Value Chain of Power Sector 2
- MoP: Revised EV Charging Infrastructure Guidelines 2
- CERC Draft Methodology for Estimation of Electricity Generated from Biomass Co-fired Thermal Power Plants 3
- CERC (Grid Interactive Distributed Renewable Energy Sources) Regulations, 2019 3
- CERC (Standard of Performance in Distribution of Electricity) Regulation, 2019 (Draft) 4
- ERC Business Plan Regulations, 2019 5

ERC Tracker

- Regulatory Updates 7
- Tariff Orders 11
- Regulations 11

CER News

- 2nd Global Regulatory Perspectives Programme for Commissioners of Electricity Regulatory Commissions 12
- EV Free Regulations at cer.lik.ac.in 16

Access online



cer.lik.ac.in/news_letter

Founder & Coordinator, Centre for Energy Regulation

The Centre is hosted in the Department of Industrial and Management Engineering, IIT Kanpur and is seed funded by Government of United Kingdom through a project titled 'Supporting Structural Reforms in the Indian Power Sector' under Power Sector Reforms (PSR) programme.



Centre for Energy Regulation (CER), Department of Industrial and Management Engineering, Indian Institute of Technology Kanpur, Kanpur - 208016 (India)

© CER, IIT Kanpur

Discussion Forum Online Learning Portal Newsletter Publications CER Events **CER Blog** Contact us Careers Login

Home / Blog

CER's Regulatory Blog

Distribution > Standard of Performance

2020-05-06 11:44:59

CS CSERC Standard of Performance (SoP) in Distribution of Electricity Regulation, 2020

Keywords: Standard of Performance, DISCOMs, ARR, Consumer Awareness, SoP Compensation.

Highlights -

The Standard of Performance (SoP) regulation issued by CSERC on 15th May 2020 allows variation across geographical areas of DISCOM, and across DISCOMs. A summary is below:

1. If the licensee fails to maintain SoP, it is liable to compensate consumer at rates specified in the regulation, which cannot be claimed in ARR.
2. To spread awareness regarding SOP among consumers and staff, the licensee to make manuals available at offices and on the website, display guaranteed standards of performance at local offices.
3. The licensee is to submit quarterly report on the level of performance achieved, and on the number of cases in which compensation was payable and the amount paid/payable in each case to the commission.

CER Opinion -

1. A SoP Index can be developed based on key performance parameters for each feeder and consumers connected to it, which should be used for implementing a penalty/incentive framework for the associated employees.
2. Given that DISCOM would manage a system of complaint registration and follow thereof, such a system should have a mandatory audit trail with due communication (SMS/email) to the consumers.
3. The commission may periodically review the current level of performance and setup multi-year benchmarks for SoP.

Home About us Discussion Forum Newsletter Publications CER Events **CER Blog** Contact us Careers Login

Home / Blog

CER's Regulatory Blog

Fundamentals of Renewable Energy: Economics, Policy and Regulation > RE Policy and Regulation

2008-07-06 15:17:36

WB WBERC's Draft for Amendment to Cogeneration and Generation of Electricity from Renewable Sources of Energy Regulations

Keywords: Renewable Energy, Cogeneration, Net-metering, Solar Rooftop, RPO Regulations, RPO Targets, West Bengal, Solar REC, Non-solar REC

Highlights -

The WBERC notified draft for the amendment to Cogeneration and Generation of Electricity from Renewable Sources of Energy Regulations, 2013. Highlights are below:

1. Consumer can install rooftop system of 1 kW or above capacity (up to total sanctioned load or contract demand) can claim net-metering/net-billing benefits.
2. DISCOMs are proposed to procure 100% of energy from waste to energy plants in their respective areas.
3. Unmet solar RPO obligation above the 85% of total RPO can be met by non-solar energy, and vice-versa.

CER Opinion -

1. RPO trajectory for the state should be specified in advance so as to provide opportunity to obligated entities to make appropriate investments or plan to procure RE/REC.
2. In case the tariff for RE has been discovered under section 63 of EA, 2003 and has been adopted by the commission, the same should not be subjected to the price cap under regulation 6.0.
3. An RPO compliance framework, supported with penalty in proportion to the shortfall, would help ensure that obligated entities take adequate steps to meet their RPO.

Copyright © IIT Kan



CER's Regulatory Database Dashboard & Online Learning Platform (under

Monograph – ‘Regulatory Framework for Long-term Demand Forecasting and Power Procurement Planning’

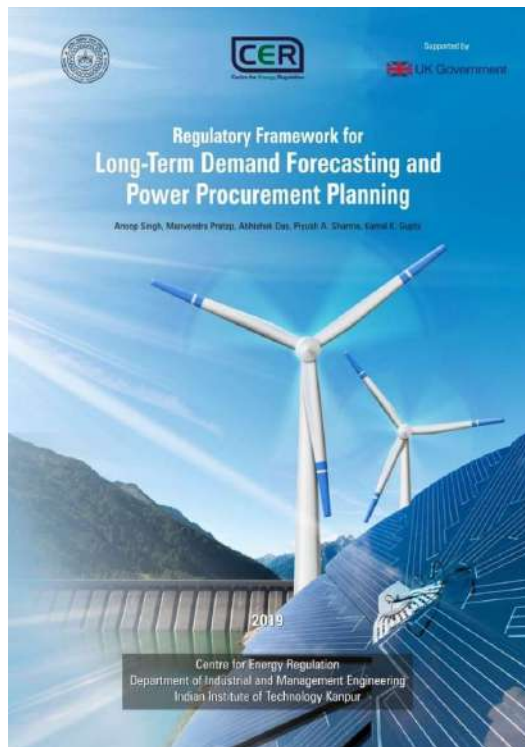

conclude that some of the EPS had overestimated the demand for electricity. As shown in Figures 5 and 6 and Tables 2 and 3, the 18th EPS had significantly overestimated the electricity demand, actual demand growth was much lower than expected. Therefore, demand projections in the 19th EPS were accordingly reduced by over 23 percent based on a lower estimated demand growth. The forecasted values of demand in the 19th EPS were closer to the actual values during the initial years, but there were significant deviations in the subsequent years. Compound Average Growth Rate (CAGR) of the projected electrical energy requirement during 2010-11 to 2015-16 was 7.62 percent, whereas the actual CAGR for the same period was 3.23 percent. Moreover, the CAGR of peak demand for 2010-11 to 2015-16 was actually 4.63 percent against the predicted value of 8.50 percent.

Table 2. Comparison of electricity demand projections in 18th and 19th EPS Reports

Year	Actual Demand (MW)	Peak Electricity Demand				Difference between 18 th and 19 th EPS (MW)
		18 th EPS Projections (MW)	Overestimated Demand in 18 th EPS (MW)	19 th EPS Projections (MW)	Overestimated Demand in 19 th EPS (MW)	
(1)	(2)	(3)	(4) = (2) - (3)	(5)	(6) = (2) - (5)	(7) = (5) - (3)
2010-11	4,22,287	1,22,287	0			
2011-12	4,30,006	1,12,885	2,679			
2012-13	4,35,453	1,43,267	3,914			
2013-14	4,35,918	1,56,208	20,290			
2014-15	4,46,166	1,69,491	24,325			
2015-16	4,53,366	1,83,902	30,536			
2016-17	4,59,542	1,99,540	19,998	1,81,834	2,292	57,706
2017-18	4,64,066	2,14,093	30,027	1,76,897	12,431	57,196
2018-21		2,43,470		2,25,781		57,719
2026-27		4,00,703		2,98,774		1,01,931

Source: 18th and 19th Electric Power Survey of India, CEER-12

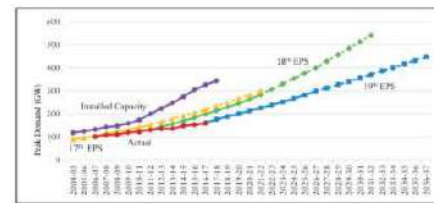

Figure 5. Historical projections of annual peak electricity demand (all India)

Source: 18th, 19th and 19th Electric Power Survey of India, CEER-15; Load Generation Database Reports (LGR), (2010-13)

Recommendations

Based on the projected electricity demand, power procurement portfolio till 2026-27 was recommended for the realistic scenario, considering policy targets for RE and DSM, under two scenarios – with and without short-term power procurement – as represented in Figures 26 and 27 respectively.

Figure 26. Realistic growth – Policy target (with Short-term Power Procurement)

Figure 27. Realistic growth – Policy target (without Short-term Power Procurement)

A number of alternate strategies included floating the candidate plants to maximize the overall private and social costs. Based on the findings of the study, estimating significantly higher economic benefits for the full-fledged procurement strategy it was suggested that the distribution utilities should undertake such an exercise more frequently.

Energy Analytics Lab (EAL)

eal.iitk.ac.in/

All India Demand-met & Generation - Snapshot

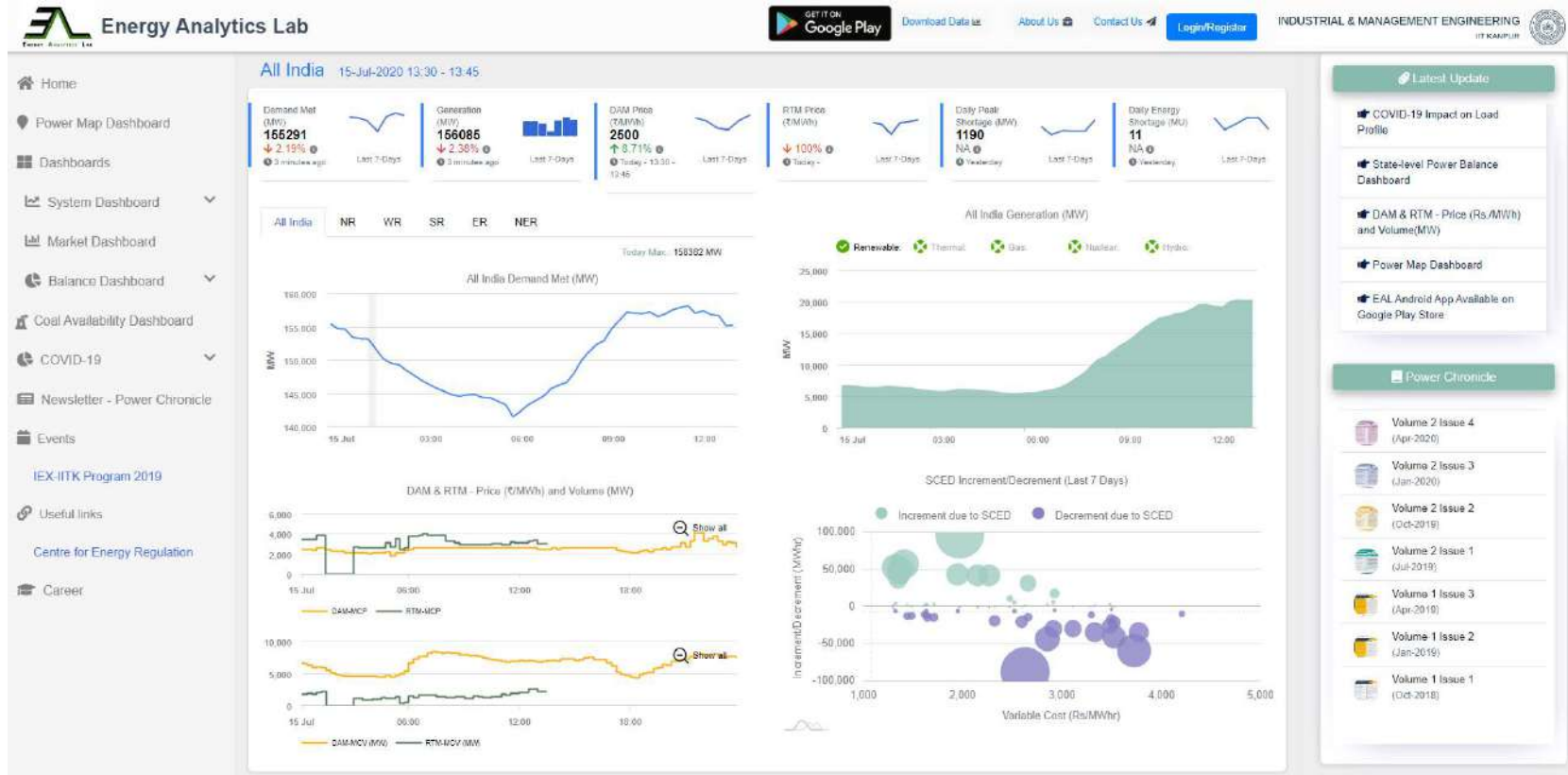

Power Map Dashboard (NEW)

Energy Analytics Lab

Power Analytics Lab

Power Map Dashboard

Click on map marker to see the details

Details of Power Generating Stations

BAPSINGAR LIGNITE - 1	
Region	Northern Region
Ownership	Central Sector
Capacity	125 MW
Plant type	Thermal Plant

SINGRAULI STPS - 6

SINGRAULI STPS - 5

SINGRAULI STPS - 4

SINGRAULI STPS - 3

SINGRAULI STPS - 1

SINGRAULI SOLAR PV

About Us | Contact Us | Disclaimer | Terms of Use | Copyright | Feedback

SECURED BY

10:26
15-07-2020

States Annual (&Monthly) 15-min Block & Hourly Load Profile (NEW)

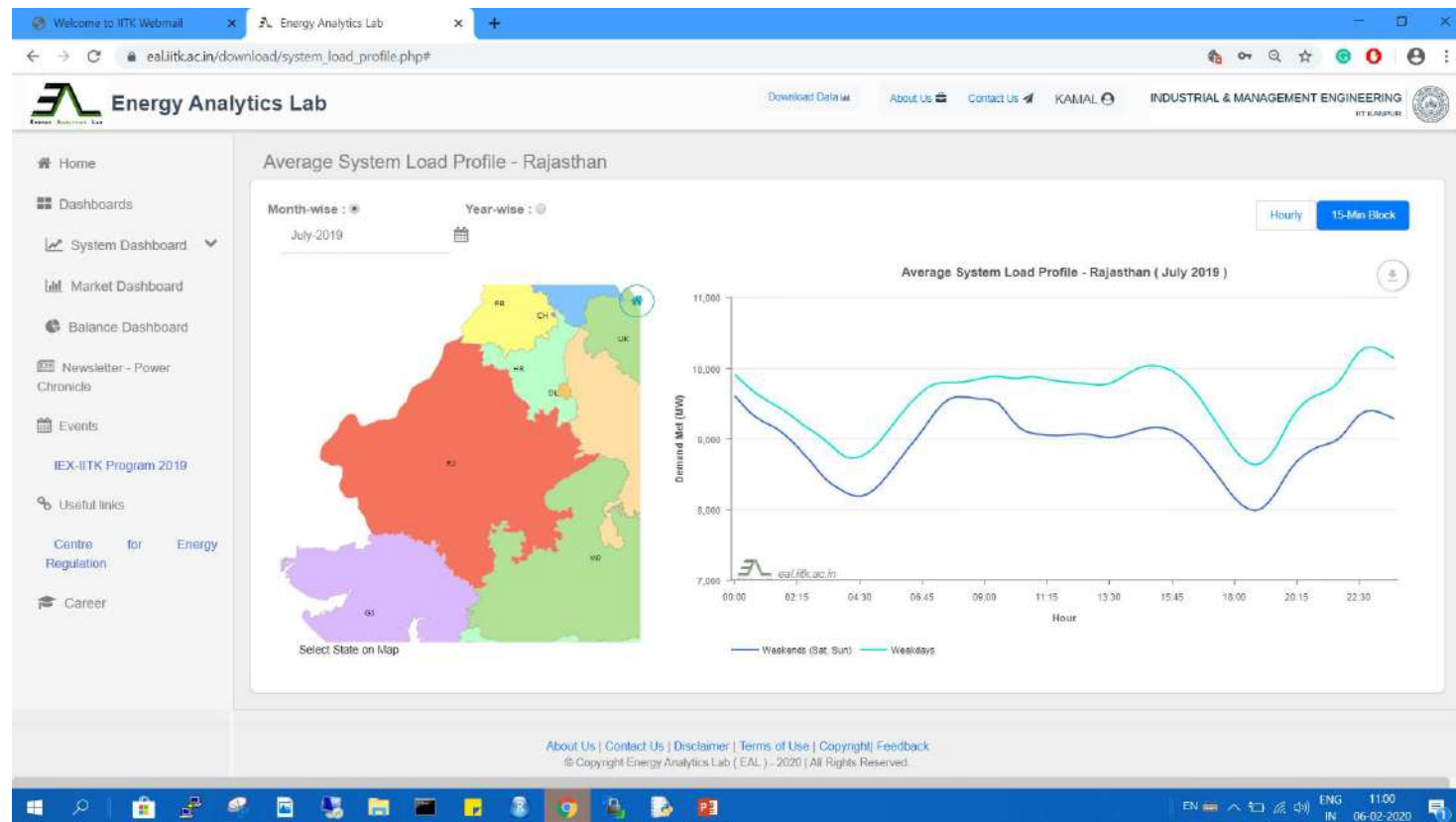

Copyright © IIT Kanpur

All India Annual & Monthly 15-min & Hourly RE Generation Profile (NEW)

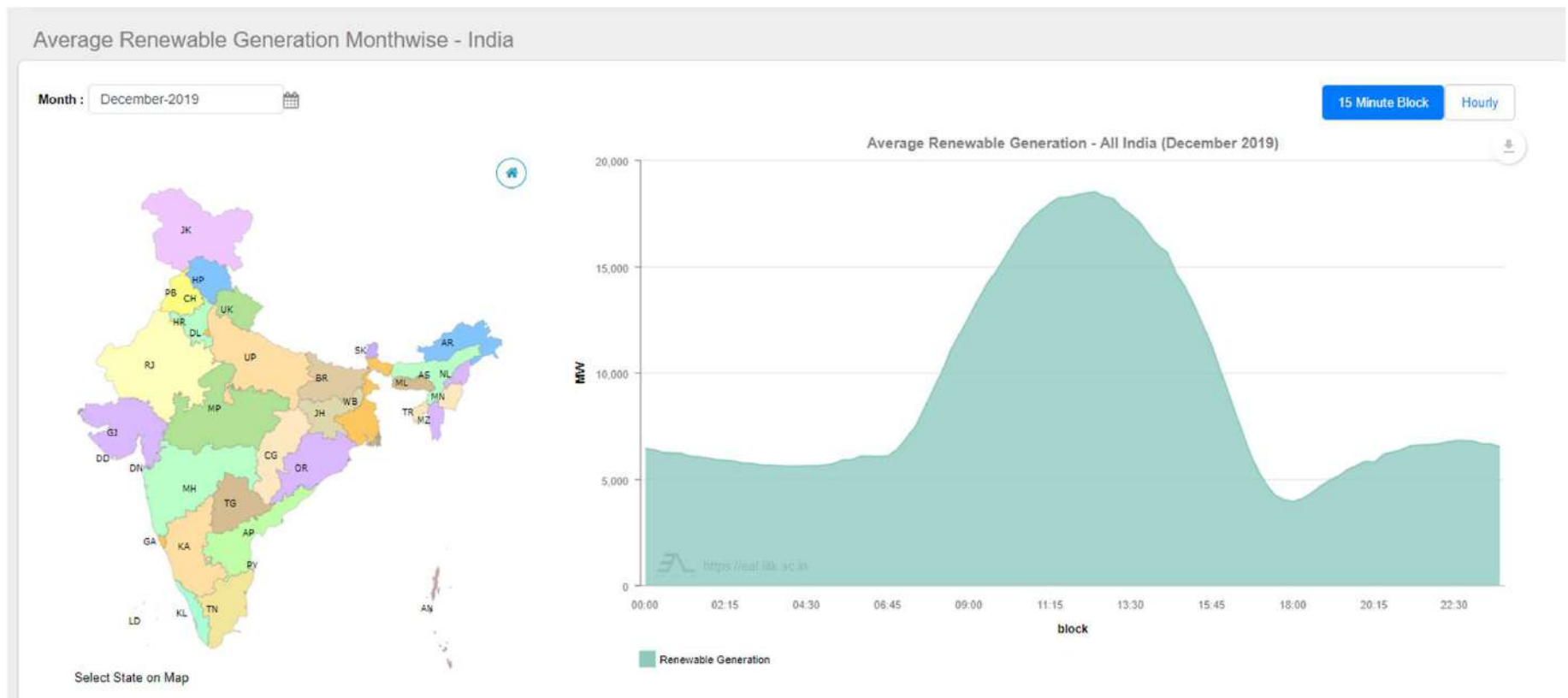

Coal Stock Position at Power Plants (NEW)

Coal Availability Data

© 19-Jan-2020 14:30 - 14:45

NR Plants All NR region Plants

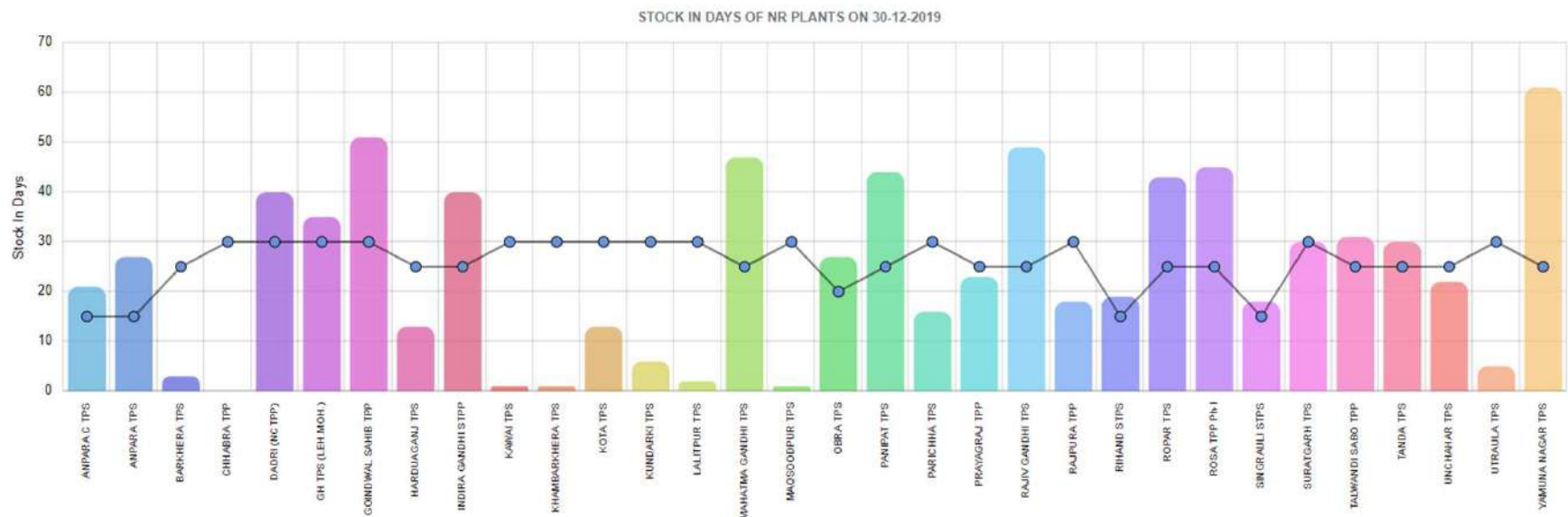

Power Market Dashboard

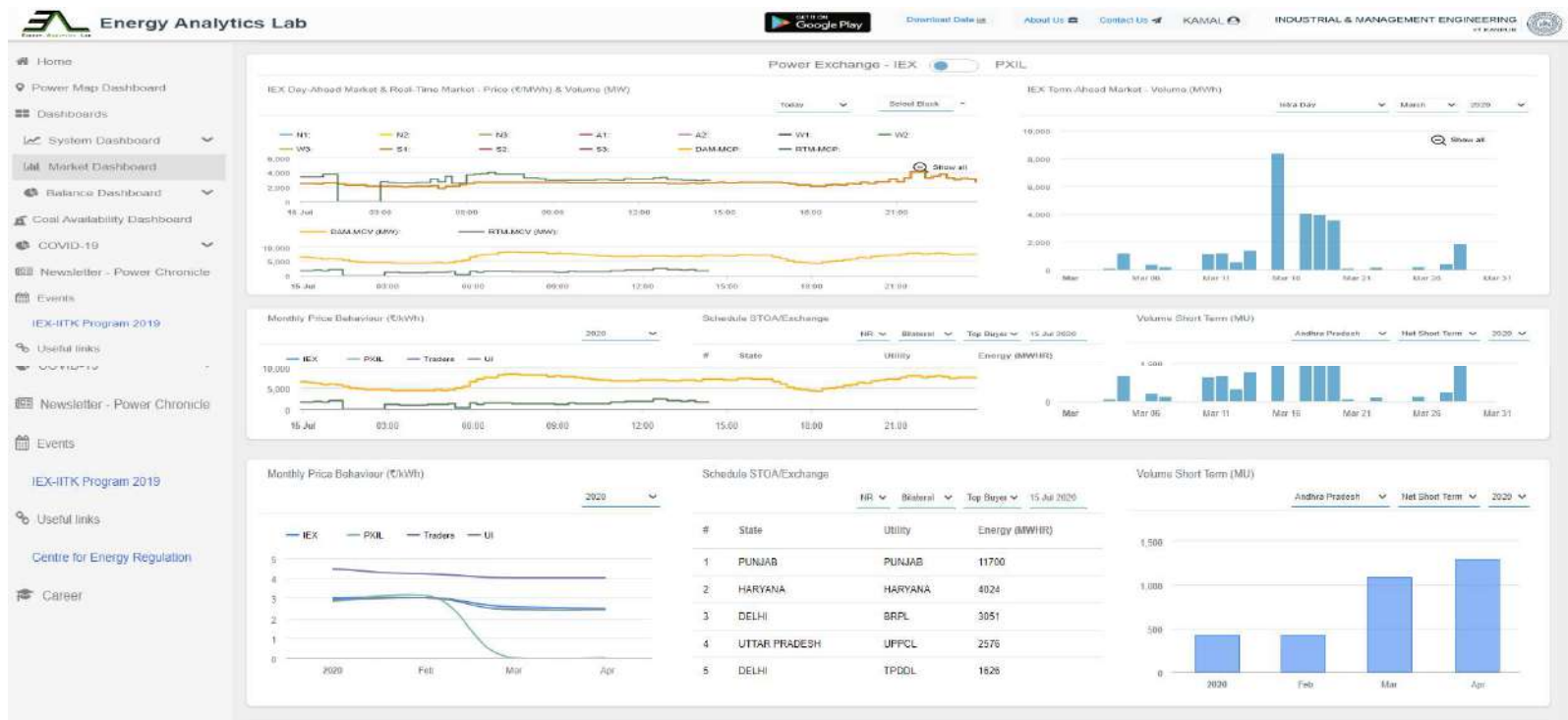

EAL Newsletter – Power Chronicle

All Newsletters

Volume 01

Volume 02

ENERGY ANALYTICS LAB
Department of Electrical and Management Engineering
IIT Kanpur

Volume 1 Issue 1
July 2019

Power Chronicle

Power System Overview & Analysis

- All India Demand Side Profile
- Regulatory Oversight for Power
- The Operational Aspects of Demand
- Response to Market Demand (R2M)
- Response to Market Demand (R2M) - A Study
- All India Demand Side Profile (DSR)
- All India Demand Side Profile (DSR) - A Study

Power Market Overview & Analysis

- Bidding - Market Clearing Price (MCP)
- Market Clearing Price (MCP)
- Market Clearing Price (MCP) - A Study
- Market Clearing Price (MCP) - A Study

Regulatory & Policy Perspective

- CERC - Tariff Regulation Mechanism and
- CERC - Tariff Regulation Mechanism and
- CERC - Tariff Regulation Mechanism and
- CERC - Tariff Regulation Mechanism and

Editorial

The Editor's perspective on the current state of the power sector in India, focusing on the challenges and opportunities ahead. The article discusses the impact of the COVID-19 pandemic on the power sector and the need for a comprehensive reform of the power sector to ensure a sustainable and reliable power supply for the future.

Issue 01 (July-2019)

ENERGY ANALYTICS LAB
Department of Electrical and Management Engineering
IIT Kanpur

Volume 2 Issue 2
October 2019

Power Chronicle

Power System Overview & Analysis

- All India Demand Side Profile
- Regulatory Oversight for Power
- The Operational Aspects of Demand
- Response to Market Demand (R2M)
- Response to Market Demand (R2M) - A Study
- All India Demand Side Profile (DSR)
- All India Demand Side Profile (DSR) - A Study

Power Market Overview & Analysis

- Bidding - Market Clearing Price (MCP)
- Market Clearing Price (MCP)
- Market Clearing Price (MCP) - A Study
- Market Clearing Price (MCP) - A Study

Regulatory & Policy Perspective

- CERC - Tariff Regulation Mechanism and
- CERC - Tariff Regulation Mechanism and
- CERC - Tariff Regulation Mechanism and
- CERC - Tariff Regulation Mechanism and

Editorial

The Editor's perspective on the current state of the power sector in India, focusing on the challenges and opportunities ahead. The article discusses the impact of the COVID-19 pandemic on the power sector and the need for a comprehensive reform of the power sector to ensure a sustainable and reliable power supply for the future.

Issue 02 (October-2019)

ENERGY ANALYTICS LAB
Department of Electrical and Management Engineering
IIT Kanpur

Volume 3 Issue 3
January 2020

Power Chronicle

Power System Overview & Analysis

- All India Demand Side Profile
- Regulatory Oversight for Power
- The Operational Aspects of Demand
- Response to Market Demand (R2M)
- Response to Market Demand (R2M) - A Study
- All India Demand Side Profile (DSR)
- All India Demand Side Profile (DSR) - A Study

Power Market Overview & Analysis

- Bidding - Market Clearing Price (MCP)
- Market Clearing Price (MCP)
- Market Clearing Price (MCP) - A Study
- Market Clearing Price (MCP) - A Study

Regulatory & Policy Perspective

- CERC - Tariff Regulation Mechanism and
- CERC - Tariff Regulation Mechanism and
- CERC - Tariff Regulation Mechanism and
- CERC - Tariff Regulation Mechanism and

Editorial

The Editor's perspective on the current state of the power sector in India, focusing on the challenges and opportunities ahead. The article discusses the impact of the COVID-19 pandemic on the power sector and the need for a comprehensive reform of the power sector to ensure a sustainable and reliable power supply for the future.

Issue 03 (January-2020)

ENERGY ANALYTICS LAB
Department of Electrical and Management Engineering
IIT Kanpur

Volume 3 Issue 4
April 2020

Power Chronicle

Power System Overview & Analysis

- All India Demand Side Profile
- Regulatory Oversight for Power
- The Operational Aspects of Demand
- Response to Market Demand (R2M)
- Response to Market Demand (R2M) - A Study
- All India Demand Side Profile (DSR)
- All India Demand Side Profile (DSR) - A Study

Power Market Overview & Analysis

- Bidding - Market Clearing Price (MCP)
- Market Clearing Price (MCP)
- Market Clearing Price (MCP) - A Study
- Market Clearing Price (MCP) - A Study

Regulatory & Policy Perspective

- CERC - Tariff Regulation Mechanism and
- CERC - Tariff Regulation Mechanism and
- CERC - Tariff Regulation Mechanism and
- CERC - Tariff Regulation Mechanism and

Editorial

The Editor's perspective on the current state of the power sector in India, focusing on the challenges and opportunities ahead. The article discusses the impact of the COVID-19 pandemic on the power sector and the need for a comprehensive reform of the power sector to ensure a sustainable and reliable power supply for the future.

Issue 04 (April-2020)

Copyright © IIT Kanpur

Register to access resources

cer.iitk.ac.in

eal.iitk.ac.in

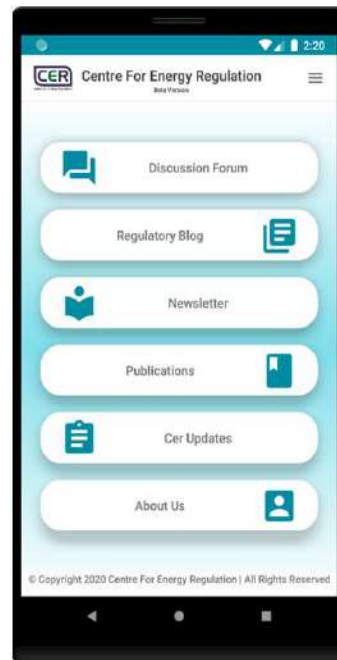

CER's Android App

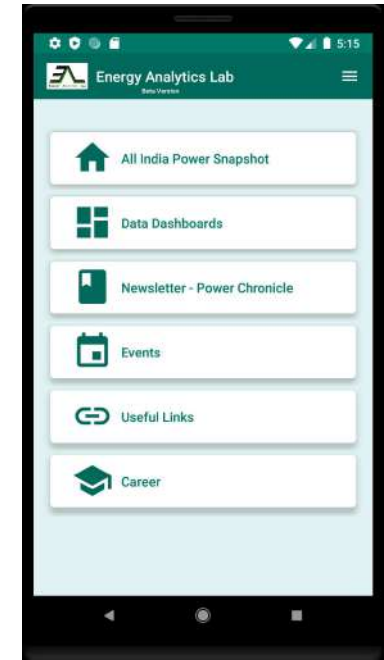
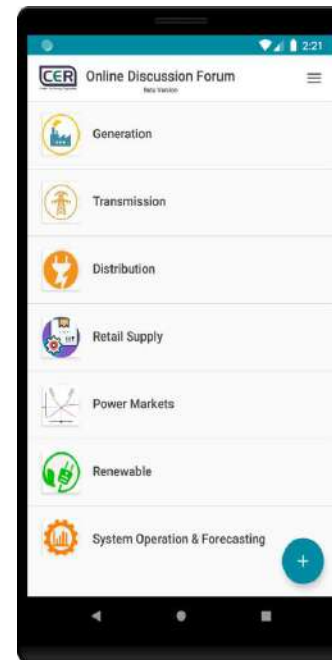

EAL's Android App

Copyright © IIT Kanpur

Under-utilization of generating stations and procurement from renewable sources



Under-utilization of generating stations

Hypothesis: Optimal utilization of TPPs may lead to reduction in electricity tariffs

Reason for under-utilization of generating station

1 Shortage of coal

3 Not following Merit Order Dispatch properly

2 Generating plants running on technical minimum due to higher energy availability.

4 Targets set by Ministry of Power for RE procurement

❑ Issue of coal shortage and technical minimum can be handled by retiring old coal based TPP as discussed in previous section. States like Madhya Pradesh, Gujarat, Andhra Pradesh etc. are surplus states.

❑ Recently, MERC has issued guidelines for operation of Merit Order Dispatch under availability-based tariff order. Other states can examine the same in their state as per their Energy Gap scenario. Detailed regarding the guidelines issued by MERC are provided in subsequent slides. Proper implementation of MOD can improve the utilization of Generating Station.

❑ Procurement of Renewable Energy is one of the reason for under-utilization of Generating Stations.

Stranded Cost of Power Purchase: Punjab

Breakup of Power Purchase Cost for FY 2018-19

Particulars	Energy Received by the Licensee	Variable Cost	Fixed Cost	Other Cost	Total Cost	
Unit	MUs	Rs. Crore	Rs. Crore	Rs. Crore	Rs. Crore	Rs./Unit
Thermal	37,017	9,346	5,147	134	14,628	3.95
Hydro	5,020	777	840	255	1,872	3.73
Renewable	2,200	1,443	-	10	1,452	6.60
Others	1,502	1,014	1,056	525	2,596	17.28
Total Power purchase	45,739	12,580	7,044	923	20,547	4.49
Less : Previous Year Payments	-	-	-	-	350	
Less: Disallowance for under achievement of Losses	-	-	-	-	228	
Less : Others	-	-	-	-	63	
Approved Power Purchase Cost	45,739	12,580	7,044	923	19,906	4.35

- Fixed charges contributed about 35% of PPC and Energy cost contributed about 63%;
- Approved ARR for FY 2018-19 is Rs.30,620 Crore and PP Cost contributes 65 % of the ARR.

Stranded Cost of Power Purchase: Punjab

Details of Surrendered Power for FY 2018-19

Particulars	Units	Value
Energy Requirement	MU	57,277
Energy Surrendered	MU	8,571
Fixed Cost Paid	Rs. Crore	977
Per Unit Fixed Cost	Rs./Unit	1.14

Details of surrendered power			
Generating Stations	Energy (MU)	Fixed Cost (Rs Crore)	Rs./Unit
NTPC Stations	2,481	176	0.71
IPP's	5,086	687	1.35
Pragati Gas Plant	586	64	1.09
DVC	210	35	1.67
UMPP's	207	15	0.73
Total	8,571	977	1.14

- The state has surrendered 8,571 MUs of power (15% of the total energy requirement in 2018-19)

Stranded Cost of Power Purchase: Punjab

Surplus Energy Surrendered

Proportion of Surplus Fixed Cost to ARR		
Approved Sales for FY 2018-19	MU	49,613
Approved ARR	Rs. Crore	30,620
Approved ACoS	Rs./Unit	6.17
Fixed Cost Paid for Surrendered Power	Rs. Crore	977
Ratio of Fixed Cost Paid to ARR		3.2%

- Apart from the surrendered surplus energy, Thermal Power Plants are operating at a lower PLF.

Generating Station	Actual PLF	Net Generation	Actual per Unit Fixed Cost	Normative per Unit Fixed Cost	Variable Cost	Total Cost (Actual PLF)	Total Cost (Normative PLF)
	%	MU	Rs./Unit	Rs./Unit	Rs./Unit	Rs./Unit	Rs./Unit
GGSTP,Ropar	23.4%	1,573	3.26	0.90	3.33	6.59	4.23
GHTP Lehra	30.5%	2,245	2.08	0.75	3.33	5.41	4.08

- Contribution of fixed cost paid for surplus power is around 3.2% to the ARR approved by the State Commission.
- Impact of Surplus Power on ACOS is around 20 paise/unit (3.2%)

Stranded Cost of Power Purchase: Punjab

Scenario Analysis: Notional loss due to plants operating at lower PLF

❑ Scenario 1 -GGSTP and GHTP operate at normative PLF

Loss on account of Lower PLF	Unit	GGSTP Ropar	GHTP Lehra
Actual Net Generation	MUs	1,573	2,245
Net Generation at Normative PLF of 85%	MUs	5,723	6,268
Total Annual Fixed Charges	Rs. Crore	512	467
Per Unit Fixed Charge at Actual PLF	Rs./kWh	3.26	2.08
Per Unit Fixed Charge at Normative PLF	Rs./kWh	0.90	0.75
Difference in Fixed Charges	Rs./kWh	2.36	1.34
Notional Loss	Rs. Crore	372	300
Total Notional Loss	Rs. Crore	672	

- Operation of State Thermal Power Plants at lower PLF has led to a normative loss of Rs. 672 Crore in addition to the fixed charges paid for surplus power.
- Total cost of stranded power including notional loss works out to around Rs 1,648 Crore (5.38% of total ARR)
- Impact of total cost of stranded power on ACoS – 33 paise/unit (Around 5.38%)

Stranded Cost of Power Purchase: Punjab

Scenario Analysis-Contribution of Renewables

❑ Scenario 2 -Power Purchase from GHTP Lehra instead of Renewables

Particulars	Energy(MU)	Total Cost(Rs. Crore)	Rs./Unit
Renewable Energy	2,200	1453	6.60
Purchase from GHTP Lehra @ Variable Cost	2,200	733	3.33
Net Savings	2,200	720	3.27

- Instead of procuring power from Renewables, if the DISCOM had procured power from GHTP (@~55% PLF), it would have led to savings of around Rs.720 Crore.
- Hence, impact of procurement from RE sources on surrendered power is around Rs 720 Crore (2.35% of ARR)

Stranded Cost of Power Purchase: Odisha

Details of Power Purchase

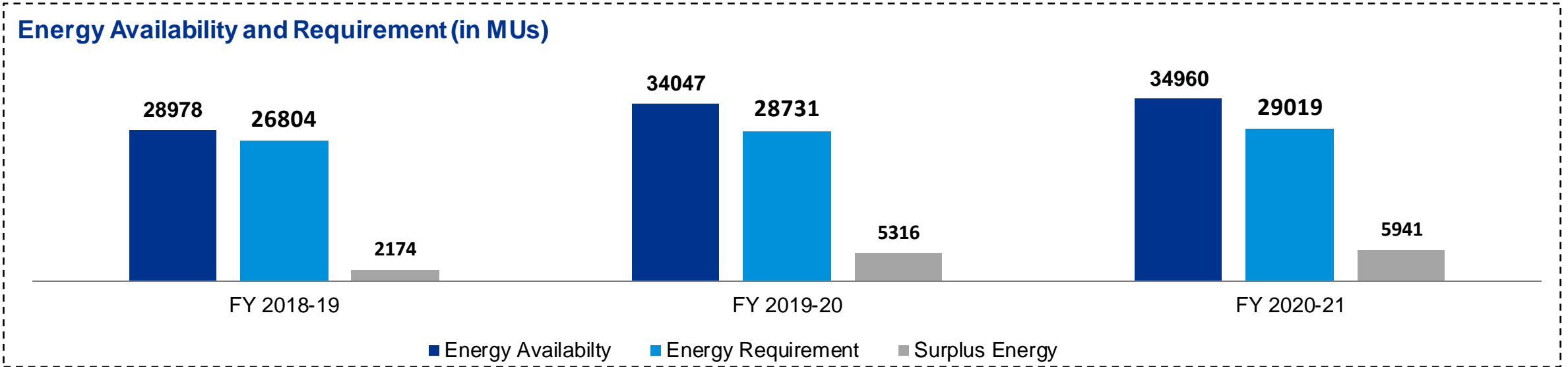

Power Purchase approved for GRIDCO(FY 2020-21)			
Particulars	MU	Rs. Crore	Rs./Unit
Thermal	19,730	5,729	2.90
Hydro	7,052	860	1.22
Renewable	2,237	866	3.87
Transmission Charges		629	
Total	29,019	8,084	2.79

- Surplus Energy is approximately 16-17% of the Energy availability for FY 20 and FY 21.

Stranded Cost of Power Purchase: Odisha

Ratio of Fixed Cost Paid to ARR

Breakup of Surrendered Power(MU)	
Generating Station	FY 2020-21
OPGC(3&4)	-
Vedanta	1,986
TSTPS-1	677
FSTPS-I & II	1,542
FSTPS-III	586
KhTPS-I	880
KhTPS-II	269
Total	5,941

Ratio of Surplus Fixed Cost to ARR		
Particulars	Units	
Approved Sales for FY 2020-21	MU	22,126
Approved ARR	Rs. Crore	11,138
Approved ACoS	Rs./Unit	5.03
Fixed Cost Paid for Surplus Power	Rs. Crore	348
Ratio of Fixed Cost Paid to ARR	%	3.13%

Fixed Cost of Surplus Power for FY 2020-21

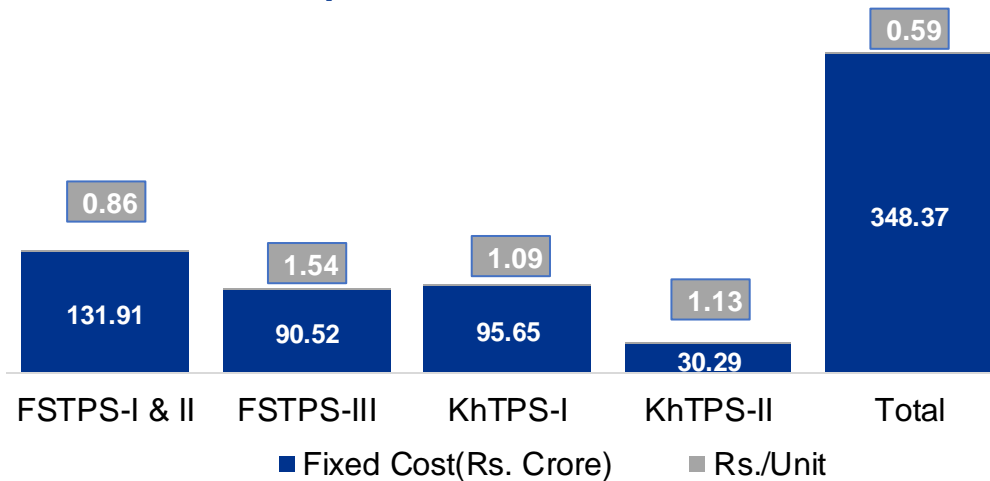

- The State Commission in the GRIDCO Tariff Order for FY 2020-21 has not allowed the fixed cost paid for surplus power and directed GRIDCO to take up the issue with the State Government.
- The State Commission in T.O for FY 2018-19 and FY 2019-20, has asked GRIDCO to recover the Revenue Gap of Rs.184 Crore and Rs.173 Crore for the respective years by trading the surplus power in the market.

Stranded Cost of Power Purchase : Madhya Pradesh

Breakup of Power Purchase Cost for FY 2019-20

Particulars	Energy Received by the Licensee	Variable Cost	Fixed Cost	Total Cost*	
Unit	MUs	Rs. Crore	Rs. Crore	Rs. Crore	Rs./Unit
Thermal	79,744	16,375	9,733	26,108	3.27
Hydro	5,798	-	1,343	1,343	2.32
Renewable	7,644	4,211	-	4,211	5.51
Others	2,282	673	-	673	2.95
Total Power purchase	95,468	21,259	11,076	32,335	3.39
Revenue for Surplus Power				9,888	
MPPMCL Cost				(730)	
Net Power Purchase Cost allowed	95,468	21,259	11,076	21,717	2.27

- Approved ARR for FY 2019-20 is Rs.32,797 Crore and PP Cost contributes 66 % of the ARR (excluding Transmission Charges).

Source : Tariff Order for FY 2019-20

* Per unit total cost has been estimated using input energy for the DISCOM

Stranded Cost of Power Purchase: Madhya Pradesh

Details of Surrendered Power for FY 2019-20

Particulars	Units	Value
Energy Requirement	MU	69,353
Energy Availability	MU	97,989
Energy Surrendered	MU	28,636
Fixed Cost of Surplus Energy	Rs. Crore	4,325
Per Unit Fixed Cost	Rs./Unit	1.51

Details of surrendered power			
Generating Stations	Energy (MU)	Fixed Cost (Rs Crore)	Rs./Unit
NTPC Stations	7,062	1,212	1.72
IPP's	19,053	3,114	1.63
Others	2,521		
Total	28,636	4,325	1.51

- The surplus energy is around 29% of the energy availability
- As per the tariff order for 2019-20, the State Commission has approved sale of surplus energy (25,658 MU) through power exchange at Rs. 3.85/unit leading to an additional revenue of Rs.9,888 Crore.

Stranded Cost of Power Purchase: Madhya Pradesh

Ratio of Surplus Fixed Cost to ARR

Ratio of Surplus Fixed Cost to ARR		
Particulars	Units	
Approved Sales for FY 2019-20	MU	55,638
Approved ARR	Rs. Crore	32,796
Approved ACoS	Rs./Unit	5.89
Fixed Cost for Surplus Power	Rs. Crore	4,325
Ratio of Fixed Cost Paid to ARR	%	13.19%

Scenario - Power Purchase from Thermal instead of Renewables

Particulars	Energy(MU)	Total Cost(Rs. Crore)	Rs./Unit
Renewable Energy	7,464	4211	5.64
Purchase from Thermal Stations @ Variable Cost	7,464	1570	2.10
Net Savings	7,464	2,641	3.54

- Impact of surplus power on ACoS is around **78 paise/unit (13.19%)**
- Instead of procuring power from Renewables, if the DISCOM had procured power from thermal stations, it would have led to savings of **around Rs. 2,641 Crore (8% of ARR)**

Stranded Cost of Power Purchase : JBVNL, Jharkhand

Breakup of Power Purchase Cost for FY 2020-21

Particulars	Energy Received by the Licensee	Variable Cost	Fixed Cost	Total Cost	
Unit	MUs	Rs. Crore	Rs. Crore	Rs. Crore	Rs./Unit
Thermal	9,206	1,902	1,898	3,800	4.13
Hydro	910	154	53	208	2.28
Renewable	1,632	535	-	535	3.28
Total Power purchase	11,749	2,591	1,951	4,543	3.87

Particulars	Units	Value
Energy Availability*	MU	11,372
Energy Requirement	MU	11,372
Fixed Cost of Surplus Energy	Rs. Crore	563

- Approved ARR for FY 2020-21 is Rs.6,326 Crore and PP Cost contributes 72 % of the ARR (excluding Transmission Charges).

Source : Tariff Order for FY 2020-21

*The Commission has estimated energy availability for FY 2020-21 on the basis of actual generation from tied-up power from Central, State-owned and other Generating Stations

Stranded Cost of Power Purchase : JBVNL, Jharkhand

Ratio of Surplus Fixed Cost to ARR

Ratio of Surplus Fixed Cost to ARR		
Particulars	Units	
Approved Sales for FY 2020-21	MU	9,894
Approved ARR	Rs. Crore	6,326
Approved ACoS	Rs./Unit	6.39
Fixed Cost for Surplus Power	Rs. Crore	563
Ratio of Fixed Cost Paid to ARR	%	8.90%

Scenario -Power Purchase from Thermal Stations instead of Renewables

Particulars	Energy(MU)	Total Cost(Rs. Crore)	Rs./Unit
Renewable Energy	1,632	535	3.28
Purchase from Thermal Stations @ Variable Cost	1,632	337	2.07
Net Savings	1,632	198	1.21

- Impact of Surplus Power on ACoS is around **57 paise/unit (8.90%)**
- Instead of procuring power from Renewables, if the DISCOM had procured power from thermal stations , it would have led to savings of around **Rs. 198 Crore (3.1% of ARR)**

Stranded Cost of Power Purchase : Assam

Breakup of Power Purchase Cost for FY 2018-19

Particulars	Energy Received by the Licensee	Fixed Cost	Variable Cost	Other Cost	Total Cost	
Unit	MUs	Rs. Crore	Rs. Crore	Rs. Crore	Rs. Crore	Rs./Unit
Thermal	6,604	1,299	1,475		2,774	4.20
Hydro	1,541	202	220		421	2.74
Renewable	92	-	53		53	5.74
Others	1,493	4	641	51	696	4.66
Total Power purchase	9,730	1,505	2,388	51	3,944	4.05
Transmission Charges					1,161	
Less: Delayed Payment Surcharge					36	
Net Power Purchase Cost allowed	9,730	1,505	2,388	51	5,069	5.21

- Approved ARR for FY 2018-19 is Rs. 5,374 Crore and PP Cost contributes 94% of the ARR including Transmission Charges and 73 % excluding Transmission Charges.

Stranded Cost of Power Purchase: Assam

Details of Surrendered Power for FY 2018-19

Particulars	Units	Value
Energy Requirement	MU	8,866
Energy Availability	MU	9,730
Energy Surplus	MU	864
Fixed Cost of Surplus Energy	Rs. Crore	294*
Per Unit Fixed Cost	Rs./Unit	3.40

Ratio of Surplus Fixed Cost to ARR		
Particulars	Units	
Approved Sales for FY 2018-19	MU	6,968
Approved ARR	Rs. Crore	5,374
Approved ACoS	Rs./Unit	7.71
Fixed Cost for Surplus Power	Rs. Crore	294*
Ratio of Fixed Cost Paid to ARR	%	5.47%

- The Surplus Energy is around 9% of the energy availability; The income earned from the sale of Surplus Power is **Rs.171 Crore @ Rs. 1.97 per Unit.**
- Impact of Surplus Power on ACOS is around **42 paise/unit.**

Source : True up Order for FY 2018-19

*Computed based on assumptions

Stranded Cost of Power Purchase: Assam

Scenario Analysis-Contribution of Renewables

❑ **Scenario** -Power Purchase from Thermal instead of Renewables

Particulars	Energy(MU)	Total Cost(Rs. Crore)	Rs./Unit
Renewable Energy	92	53	5.74
Purchase from Thermal Stations @ Variable Cost	92	21	2.23
Net Savings	92	32	3.51

- Instead of procuring power from Renewables, if the DISCOM had procured power from thermal stations , it would have led to savings of around **Rs. 32 Crore (0.6% of the ARR)**

Stranded Cost of Power Purchase : Uttarakhand

Breakup of Power Purchase Cost for FY 2020-21

Particulars	Energy Received by the Licensee	Variable Cost	Fixed Cost	Total Cost	
				Unit	MUs
Thermal	6,225	1,991	734	3,800	4.13
Hydro	6,312	953	577	208	2.28
Renewable	1,477	672	-	535	3.28
Others	282	101	-		
Total Power purchase	14,295	3,717	1,311	5,028	3.52
Short Term (Tied Up) & Deficit Purchase	487	195			
Banking including OA Charges	49	30			
Net Power Purchase Cost allowed	14,832	3,942	1,311	5,252	3.54

Particulars	Units	Value
Energy Requirement	MU	14,832
Energy Availability	MU	14,295
Energy Deficit	MU	536

- Approved ARR for FY 2020-21 is Rs.6,957 Crore and PP Cost contributes 75% of the ARR.

Stranded Cost of Power Purchase: Uttarakhand

Scenario Analysis-Contribution of Renewables

❑ Scenario - Power Purchase from Thermal instead of Renewables

Particulars	Energy(MU)	Total Cost(Rs. Crore)	Rs./Unit
Renewable Energy	1,477	672	4.55
Purchase from Thermal Stations @ Variable Cost	1,477	472	3.20
Net Savings	1,477	200	1.35

- Instead of procuring power from Renewables, if the DISCOM had procured power from Thermal Stations , it would have led to savings of around **Rs. 200 Crore (2.8% of ARR)**

Stranded Cost of Power Purchase: Bihar

Breakup of Power Purchase Cost for FY 2020-21

Particulars	Energy Received by the Licensee	Fixed Cost	Variable Cost	Other Cost	Total Cost	
Unit	MUs	Rs. Crore	Rs. Crore	Rs. Crore	Rs. Crore	Rs./Unit
Thermal	25,425	5,489	5,552	135	11,175	4.40
Hydro	3,117	150	833		983	3.15
Renewable	3,026	-	1,084		1,084	3.58
Others	816	-	342		342	4.19
Total Power purchase	32,384	5,639	7,811	135	13,584	4.19

- Approved ARR for FY 2020-21 is Rs. 18,528 Crore and PP Cost contributes 73% of the ARR excluding Transmission Charges

Stranded Cost of Power Purchase: Bihar

Details of Surrendered Power for FY 2020-21

Particulars	Units	Value
Energy Requirement	MU	32,384
Energy Availability	MU	46,686
Energy Surplus	MU	14,301
Fixed Cost of Surplus Energy	Rs. Crore	1,294*
Per Unit Fixed Cost	Rs./Unit	0.91

Ratio of Surplus Fixed Cost to ARR		
Particulars	Units	
Approved Sales	MU	26,499
Approved ARR	Rs. Crore	18,528
Approved ACoS	Rs./Unit	6.99
Fixed Cost for Surplus Power	Rs. Crore	1,294*
Ratio of Fixed Cost Paid to ARR	%	6.99%

- The surplus energy is around 31% of the energy availability,
- Impact of surplus power on ACOS is around 6.99% (48 paise/unit)

Stranded Cost of Power Purchase: Bihar

Scenario Analysis

❑ Scenario - Power Purchase from Thermal instead of Renewables

Particulars	Energy(MU)	Total Cost(Rs. Crore)	Rs./Unit
Renewable Energy	3,026	1,084	3.58
Purchase from Thermal Stations @ Variable Cost	3,026	661	2.18
Net Savings	3,026	423	1.40

- Instead of procuring power from Renewables, if the DISCOM had procured power from Thermal Stations , it would have led to savings of around Rs. 423 Crore.

Stranded Cost of Power Purchase: Uttar Pradesh

Breakup of Power Purchase Cost for FY 2020-21

Particulars	Energy Received by the Licensee	Fixed Cost	Variable Cost	Total Cost	
Unit	MUs	Rs. Crore	Rs. Crore	Rs. Crore	Rs./Unit
Thermal	101,328	19,863	24,366	44,229	4.36
Hydro	13,899	2,911	2,476	5,387	3.88
Renewable	7,523	-	3,088	3,088	4.10
Others	8,994	-	605	605	0.67
Total Power purchase	131,744	22,774	30,535	53,309	4.05

- Approved ARR for FY 2020-21 is Rs. 65,175 Crore and PP Cost contributes 82% of the ARR excluding Transmission Charges

Stranded Cost of Power Purchase: Uttar Pradesh

Details of Surrendered Power for FY 2020-21

Particulars	Units	Value
Energy Requirement	MU	1,09,328
Energy Availability	MU	1,31,744
Energy Surplus	MU	22,416
Fixed Cost of Surplus Energy	Rs. Crore	4394*
Per Unit Fixed Cost	Rs./Unit	1.96

Ratio of Surplus Fixed Cost to ARR		
Particulars	Units	
Approved Sales	MU	92,409
Approved ARR	Rs. Crore	65,175
Approved ACoS	Rs./Unit	7.05
Fixed Cost for Surplus Power	Rs. Crore	4,394*
Ratio of Fixed Cost Paid to ARR	%	6.74%

- The surplus energy is around 17% of the energy availability,
- Impact of surplus power on ACOS is 6.74% (47 paise/unit)

*Computed on the basis of Fixed Cost per Unit of Thermal Energy

Source : Tariff Order for FY 2020-21

Stranded Cost of Power Purchase: Uttar Pradesh

Scenario Analysis

❑ **Scenario-** Power Purchase from Thermal instead of Renewables

Particulars	Energy(MU)	Total Cost(Rs. Crore)	Rs./Unit
Renewable Energy	7,523	3,088	4.10
Purchase from Thermal Stations @ Variable Cost	7,523	1,809	2.40
Net Savings	7,523	1,279	1.70

- Instead of procuring power from Renewables, if the DISCOM had procured power from Thermal Stations , it would have led to savings of around Rs. 1279 Crore.

Stranded Cost of Power Purchase : Haryana

Breakup of Power Purchase Cost for FY 2020-21

Particulars	Energy Received by the Licensee	Fixed Cost	Variable Cost	Total Cost	
Unit	MUs	Rs. Crore	Rs. Crore	Rs. Crore	Rs./Unit
Thermal	51,354	5,937	15,554	21,491	4.18
Hydro	7,984	912	1,273	2,185	2.74
Renewable	3,588	-	1,251	1,251	3.49
Others	740	4	273	276	3.73
Total Power purchase	63,667	6,852	18,351	25,203	3.96
Approved PP Cost				20,868	3.28

- Approved ARR for FY 2020-21 is Rs. 27,836 Crore and PP Cost contributes 75% of the ARR excluding Transmission Charges

Stranded Cost of Power Purchase: Haryana

Details of Surrendered Power for FY 2020-21

Particulars	Units	Value
Energy Requirement	MU	48,796
Energy Availability	MU	63,667
Energy Surplus	MU	14,870
Fixed Cost of Surplus Energy	Rs. Crore	1719*
Per Unit Fixed Cost	Rs./Unit	1.16

Ratio of Surplus Fixed Cost to ARR		
Particulars	Units	
Approved Sales	MU	38,474
Approved ARR	Rs. Crore	27,836
Approved ACoS	Rs./Unit	7.23
Fixed Cost for Surplus Power	Rs. Crore	1719*
Ratio of Fixed Cost Paid to ARR	%	6.18%

- The surplus energy is around 23% of the energy availability,
- Impact of surplus power on ACOS is 6.18% (45 paise/unit)

*Computed on the basis of Fixed Cost per Unit of Thermal Energy

Source : Tariff Order for FY 2020-21

Stranded Cost of Power Purchase: Haryana

Scenario Analysis

❑ Scenario -Power Purchase from Thermal instead of Renewables

Particulars	Energy(MU)	Total Cost(Rs. Crore)	Rs./Unit
Renewable Energy	3,588	1,251	3.49
Purchase from Thermal Stations @ Variable Cost	3,588	1,087	3.03
Net Savings	3,588	165	0.46

- Instead of procuring power from Renewables, if the DISCOM had procured power from Thermal Stations , it would have led to savings of around Rs. 165 Crore.

Stranded Cost of Power Purchase : Andhra Pradesh

Breakup of Power Purchase Cost for FY 2020-21

Particulars	Energy Received by the Licensee	Fixed Cost	Variable Cost	Total Cost	
Unit	MUs	Rs. Crore	Rs. Crore	Rs. Crore	Rs./Unit
Thermal	50,545	7,894	16,016	23,910	4.73
Hydro	3,169	601	-	601	1.90
Renewable	14,392	-	6,597	6,597	4.58
Others	795	984	175	1,159	14.57
Total Power purchase	68,902	9,479	22,788	32,268	4.68

- Approved ARR for FY 2020-21 is Rs. 42,494 Crore and PP Cost contributes 76% of the ARR excluding Transmission Charges

Stranded Cost of Power Purchase: Andhra Pradesh

Details of Surrendered Power for FY 2020-21

Particulars	Units	Value
Energy Requirement	MU	68,902
Energy Availability	MU	78,406
Energy Surplus	MU	9,504
Fixed Cost of Surplus Energy	Rs. Crore	917*
Per Unit Fixed Cost	Rs./Unit	0.96

Ratio of Surplus Fixed Cost to ARR		
Particulars	Units	
Approved Sales	MU	61,819
Approved ARR	Rs. Crore	42,494
Approved ACoS	Rs./Unit	6.87
Fixed Cost for Surplus Power	Rs. Crore	917*
Ratio of Fixed Cost Paid to ARR	%	2.16%

- The surplus energy is around 12% of the energy availability,
- Impact of surplus power on ACOS is 2.16% (14 paise/unit)

*Computed on the basis of Fixed Cost per Unit of Station wise Thermal Energy

Source : Tariff Order for FY 2020-21

Stranded Cost of Power Purchase: Andhra Pradesh

Scenario Analysis

❑ Scenario -Power Purchase from Thermal instead of Renewables

Particulars	Energy(MU)	Total Cost(Rs. Crore)	Rs./Unit
Renewable Energy	14,392	6,597	4.58
Purchase from Thermal Stations @ Variable Cost	14,392	4,560	3.17
Net Savings	14,392	2,037	1.42

- Instead of procuring power from Renewables, if the DISCOM had procured power from Thermal Stations , it would have led to savings of around Rs. 2037 Crore.

Stranded Cost of Power Purchase : Gujarat

Breakup of Power Purchase Cost for FY 2020-21

Particulars	Energy Received by the Licensee	Fixed Cost	Variable Cost	Total Cost	
Unit	MUs	Rs. Crore	Rs. Crore	Rs. Crore	Rs./Unit
Thermal	88,217	12,017	19,173	31,190	3.54
Hydro	599	115	-	115	1.92
Renewable	16,533	40	6,813	6,853	4.15
Others	302	-	121	121	4.02
Total Power purchase	105,652	12,173	26,105	38,277	3.62

- Approved ARR for FY 2020-21 is Rs. 51,712 Crore and PP Cost contributes 74% of the ARR excluding Transmission Charges

Stranded Cost of Power Purchase: Gujarat

Details of Surrendered Power for FY 2020-21

Particulars	Units	Value
Energy Requirement	MU	1,05,652
Energy Availability	MU	1,16,872
Energy Surplus	MU	1,12,20
Fixed Cost of Surplus Energy	Rs. Crore	1,528*
Per Unit Fixed Cost	Rs./Unit	1.36

Ratio of Surplus Fixed Cost to ARR		
Particulars	Units	
Approved Sales	MU	87,824
Approved ARR	Rs. Crore	51,712
Approved ACoS	Rs./Unit	5.89
Fixed Cost for Surplus Power	Rs. Crore	1,528*
Ratio of Fixed Cost Paid to ARR	%	2.96%

- The surplus energy is around 10% of the energy availability,
- Impact of surplus power on ACOS is 2.96% (17 paise/unit)

*Computed on the basis of Fixed Cost per Unit of Thermal Energy
 Source : MTR for FY 2019-20 to FY 2020-21

Stranded Cost of Power Purchase: Gujarat

Scenario Analysis

❑ Scenario - Power Purchase from Thermal instead of Renewables

Particulars	Energy(MU)	Total Cost(Rs. Crore)	Rs./Unit
Renewable Energy	16,533	6,853	4.15
Purchase from Thermal Stations @ Variable Cost	16,533	3,593	2.17
Net Savings	16,533	3,260	1.97

- Instead of procuring power from Renewables, if the DISCOM had procured power from Thermal Stations , it would have led to savings of around Rs. 3260 Crore.

Stranded Cost of Power Purchase : Kerala

Breakup of Power Purchase Cost for FY 2020-21

Particulars	Energy Received by the Licensee	Fixed Cost	Variable Cost	Other Cost	Total Cost	
Unit	MUs	Rs. Crore	Rs. Crore	Rs. Crore	Rs. Crore	Rs./Unit
Thermal	19,975	3,090	5,293	(119)	8,264	4.14
Hydro	88	-	-		31	3.48
Renewable	1,397	-	-		384	2.75
Others	385	-	-		216	5.62
Total Power purchase	21,845	3,090	5,293	(119)	8,895	4.07

- Approved ARR for FY 2020-21 is Rs. 15,936 Crore and PP Cost contributes 56% of the ARR excluding Transmission Charges

Stranded Cost of Power Purchase: Kerala

Details of Surrendered Power for FY 2020-21

Particulars	Units	Value
Energy Requirement	MU	26,674
Energy Availability	MU	27,456
Energy Surplus	MU	782
Fixed Cost of Surplus Energy	Rs. Crore	121*
Per Unit Fixed Cost	Rs./Unit	1.55

Ratio of Surplus Fixed Cost to ARR		
Particulars	Units	
Approved Sales	MU	23,454
Approved ARR	Rs. Crore	15,936
Approved ACoS	Rs./Unit	6.77
Fixed Cost for Surplus Power	Rs. Crore	121*
Ratio of Fixed Cost Paid to ARR	%	0.76%

- The Surplus Energy is around 3% of the Energy Availability;
- Impact of Surplus Power on ACOS is 0.76%.

Stranded Cost of Power Purchase: Kerala

Scenario Analysis

❑ Scenario -Power Purchase from Thermal instead of Renewables

Particulars	Energy(MU)	Total Cost(Rs. Crore)	Rs./Unit
Renewable Energy	1,397	384	2.75
Purchase from Thermal Stations @ Variable Cost	1,397	370	2.65
Net Savings	1,397	14	0.10

- Instead of procuring power from Renewables, if the DISCOM had procured power from Thermal Stations , it would have led to savings of around Rs. 14 Crore.

Summary: Under-utilization of generating stations

Hypothesis: Optimal utilization of TPPs may lead to reduction in electricity tariffs

- ❑ Under-utilization of generating stations could be attributed to shortage of coal, non-compliance with Merit Order Dispatch, procurement from RE sources, and generating plants running on technical minimum due to higher energy availability.
- ❑ In Punjab, operation of State Thermal Power Plants at lower PLF has led to a normative loss of **Rs. 672 Crore** in addition to the fixed charges paid for surplus power.
- ❑ Fixed cost paid for surplus power varied in the range of **1-13% of the total ARR** for the 12 states
- ❑ Instead of procuring power from Renewables, if DISCOMs had procured power from TPPs, it would have led to savings of around **Rs. 11,000 Crore** for 12 states. **(3% of the total ARR)**

Total Impact of Clean Energy Cess over last 10 Years



Clean Energy Cess

Impact of Clean Energy Cess considering Coal Consumption by Energy Sector

Year	Coal Consumption	Total Impact of Clean Energy Cess
	Million MT	Rs. Crore
2010-11	396	990
2011-12	438	2,188
2012-13	485	2,427
2013-14	493	2,466
2014-15	498	3,733
2015-16	518	9,492
2016-17	535	19,618
2017-18*	608	24,320
2018-19*	629	25,144
2019-20*	622	24,883

Notification	June 2010	July 2014	Feb. 2015	March 2016
Clean Energy Cess(Rs./Tonne)	50	100	200	400

- The amount collected has increased after 2016-17 with increase in Coal Consumption and increase in Cess(Rs./MT).

Source : MOSPI (Energy Statistics 2019)

*Computed based on Monthly CEA Fuel Reports

Under-utilization of generating stations and procurement from renewable sources



Under-utilization of generating stations

Hypothesis: Optimal utilization of TPPs may lead to reduction in electricity tariffs

Reason for under-utilization of generating station

1 Shortage of coal

2 Generating plants running on technical minimum due to higher energy availability.

3 Not following Merit Order Dispatch properly

4 Targets set by Ministry of Power for RE procurement

❑ Issue of coal shortage and technical minimum can be handled by retiring old coal based TPP as discussed in previous section. States like Madhya Pradesh, Gujarat, Andhra Pradesh etc. are surplus states.

❑ Recently, MERC has issued guidelines for operation of Merit Order Dispatch under availability-based tariff order. Other states can examine the same in their state as per their Energy Gap scenario. Detailed regarding the guidelines issued by MERC are provided in subsequent slides. Proper implementation of MOD can improve the utilization of Generating Station.

❑ Procurement of Renewable Energy is one of the reason for under-utilization of Generating Stations.

Stranded Cost of Power Purchase: Punjab

Breakup of Power Purchase Cost for FY 2018-19

Particulars	Energy Received by the Licensee	Variable Cost	Fixed Cost	Other Cost	Total Cost	
Unit	MUs	Rs. Crore	Rs. Crore	Rs. Crore	Rs. Crore	Rs./Unit
Thermal	37,017	9,346	5,147	134	14,628	3.95
Hydro	5,020	777	840	255	1,872	3.73
Renewable	2,200	1,443	-	10	1,452	6.60
Others	1,502	1,014	1,056	525	2,596	17.28
Total Power purchase	45,739	12,580	7,044	923	20,547	4.49
Less : Previous Year Payments	-	-	-	-	350	
Less: Disallowance for under achievement of Losses	-	-	-	-	228	
Less : Others	-	-	-	-	63	
Approved Power Purchase Cost	45,739	12,580	7,044	923	19,906	4.35

- Fixed charges contributed about 35% of PPC and Energy cost contributed about 63%;
- Approved ARR for FY 2018-19 is Rs.30,620 Crore and PP Cost contributes 65 % of the ARR.

Stranded Cost of Power Purchase: Punjab

Details of Surrendered Power for FY 2018-19

Particulars	Units	Value
Energy Requirement	MU	57,277
Energy Surrendered	MU	8,571
Fixed Cost Paid	Rs. Crore	977
Actual Fixed Cost Per Unit Availed	Rs./Unit	1.41
Total Fixed Cost Per Unit	Rs./Unit	1.14

Details of surrendered power						
Generating Stations	Energy Received (MU)	Energy Surrendered (MU)	Total Energy	Fixed Cost (Rs Crore)	Per Unit Fixed Cost of Energy Availed (Rs./unit)	Per Unit Fixed Cost for Total Energy (Availed + Surrendered) (Rs./unit)
NTPC Stations	5614	2,481	8,095	712	1.27	0.88
IPP's	20712	5,086	25,799	3,481	1.68	1.35
Pragati Gas Plant	246	586	832	92	3.72	1.10
DVC	2997	210	3,207	570	1.90	1.78
UMPP's	7485	207	7,692	367	0.49	0.48
Total	37,054	8,571	45,625	5,222	1.41	1.14

- The state has surrendered 8,571 MUs of power (15% of the total energy requirement in 2018-19)

Stranded Cost of Power Purchase: Punjab

Surplus Energy Surrendered

Proportion of Surplus Fixed Cost to ARR		
Approved Sales for FY 2018-19	MU	49,613
Approved ARR	Rs. Crore	30,620
Approved ACoS	Rs./Unit	6.17
Fixed Cost Paid for Surrendered Power	Rs. Crore	977
Ratio of Fixed Cost Paid to ARR		3.2%

- Apart from the surrendered surplus energy, Thermal Power Plants are operating at a lower PLF.

Generating Station	Actual PLF	Net Generation	Actual per Unit Fixed Cost	Normative per Unit Fixed Cost	Variable Cost	Total Cost (Actual PLF)	Total Cost (Normative PLF)
	%	MU	Rs./Unit	Rs./Unit	Rs./Unit	Rs./Unit	Rs./Unit
GGSTP,Ropar	23.4%	1,573	3.26	0.90	3.33	6.59	4.23
GHTP Lehra	30.5%	2,245	2.08	0.75	3.33	5.41	4.08

- Contribution of fixed cost paid for surplus power is around 3.2% to the ARR approved by the State Commission.
- Impact of Surplus Power on ACOS is around 20 paise/unit (3.2%)

Stranded Cost of Power Purchase: Punjab

Scenario Analysis: Notional loss due to plants operating at lower PLF

❑ Scenario 1 -GGSTP and GHTP operate at normative PLF

Loss on account of Lower PLF	Unit	GGSTP Ropar	GHTP Lehra
Actual Net Generation	MUs	1,573	2,245
Net Generation at Normative PLF of 85%	MUs	5,723	6,268
Total Annual Fixed Charges	Rs. Crore	512	467
Per Unit Fixed Charge at Actual PLF	Rs./kWh	3.26	2.08
Per Unit Fixed Charge at Normative PLF	Rs./kWh	0.90	0.75
Difference in Fixed Charges	Rs./kWh	2.36	1.34
Notional Loss	Rs. Crore	372	300
Total Notional Loss	Rs. Crore	672	

- Operation of State Thermal Power Plants at lower PLF has led to a normative loss of Rs. 672 Crore in addition to the fixed charges paid for surplus power.
- Total cost of stranded power including notional loss works out to around Rs 1,648 Crore (5.38% of total ARR)
- Impact of total cost of stranded power on ACoS – 33 paise/unit (Around 5.38%)

Stranded Cost of Power Purchase: Punjab

Scenario Analysis-Contribution of Renewables

❑ Scenario 2 -Power Purchase from GHTP Lehra instead of Renewables

Particulars	Energy(MU)	Total Cost(Rs. Crore)	Rs./Unit
Renewable Energy	2,200	1453	6.60
Purchase from GHTP Lehra @ Variable Cost	2,200	733	3.33
Net Savings	2,200	720	3.27

- Instead of procuring power from Renewables, if the DISCOM had procured power from GHTP (@~55% PLF), it would have led to savings of around Rs.720 Crore.
- Hence, impact of procurement from RE sources on surrendered power is around Rs 720 Crore (2.35% of ARR)

Stranded Cost of Power Purchase: Odisha

Details of Power Purchase

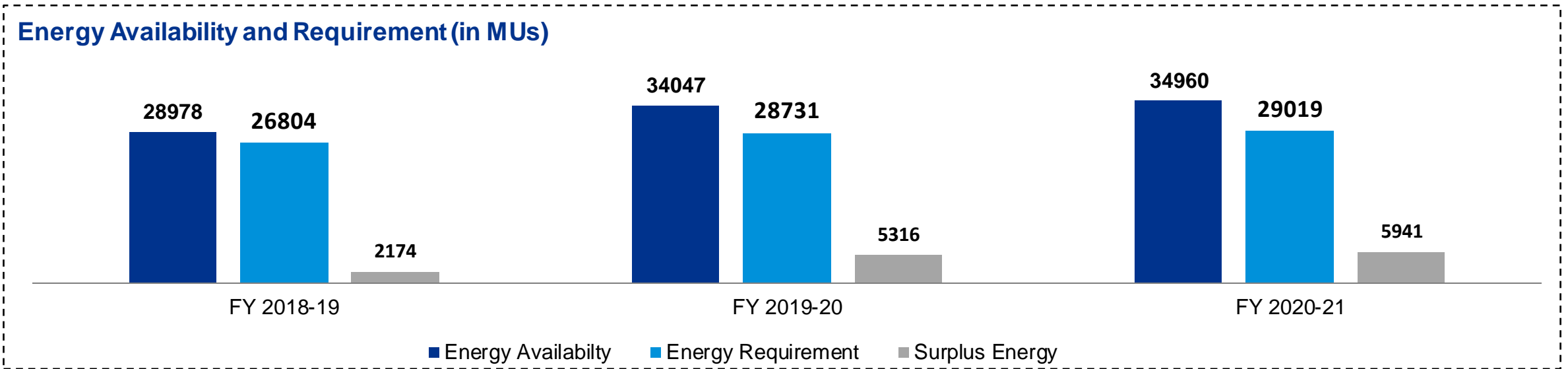

Power Purchase approved for GRIDCO(FY 2020-21)			
Particulars	MU	Rs. Crore	Rs./Unit
Thermal	19,730	5,729	2.90
Hydro	7,052	860	1.22
Renewable	2,237	866	3.87
Transmission Charges		629	
Total	29,019	8,084	2.79

- Surplus Energy is approximately 16-17% of the Energy availability for FY 20 and FY 21.

Stranded Cost of Power Purchase: Odisha

Ratio of Fixed Cost Paid to ARR

Breakup of Surrendered Power(MU)	
Generating Station	FY 2020-21
OPGC(3&4)	-
Vedanta	1,986
TSTPS-1	677
FSTPS-I & II	1,542
FSTPS-III	586
KhTPS-I	880
KhTPS-II	269
Total	5,941

Ratio of Surplus Fixed Cost to ARR		
Particulars	Units	
Approved Sales for FY 2020-21	MU	22,126
Approved ARR	Rs. Crore	11,138
Approved ACoS	Rs./Unit	5.03
Fixed Cost Paid for Surplus Power	Rs. Crore	348
Ratio of Fixed Cost Paid to ARR	%	3.13%

Fixed Cost of Surplus Power for FY 2020-21

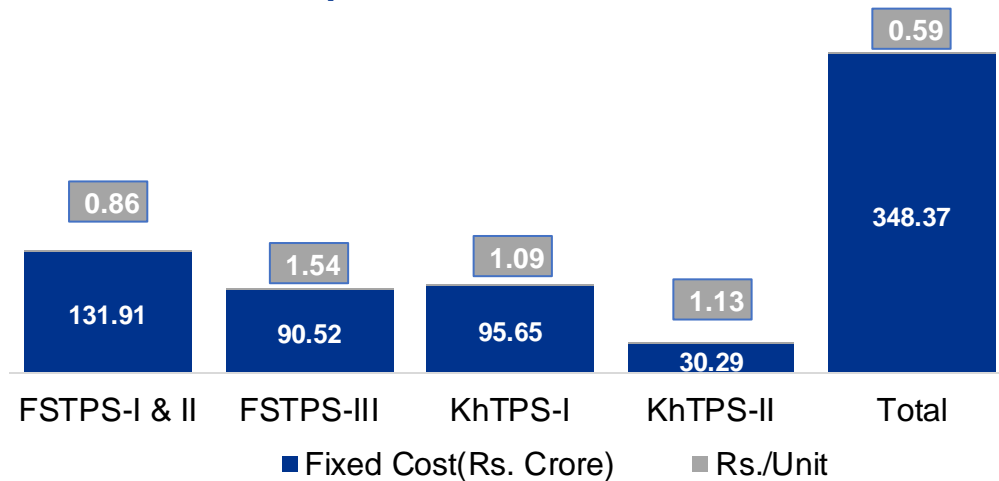

- The State Commission in the GRIDCO Tariff Order for FY 2020-21 has not allowed the fixed cost paid for surplus power and directed GRIDCO to take up the issue with the State Government.
- The State Commission in T.O for FY 2018-19 and FY 2019-20, has asked GRIDCO to recover the Revenue Gap of Rs.184 Crore and Rs.173 Crore for the respective years by trading the surplus power in the market.

Stranded Cost of Power Purchase: Orissa

Details of Surrendered Power for FY 2020-21

Particulars	Units	Value
Energy Requirement	MU	34,960
Energy Surrendered	MU	5,941
Fixed Cost	Rs. Crore	348
Actual Fixed Cost Per Unit Availed	Rs./Unit	2.12
Total Fixed Cost Per Unit	Rs./Unit	0.92

Details of surrendered power						
Generating Stations	Energy Received (MU)	Energy Surrendered (MU)	Total Energy	Fixed Cost (Rs Crore)	Per Unit Fixed Cost of Energy Availed (Rs./unit)	Per Unit Fixed Cost for Total Energy (Availed + Surrendered) (Rs./unit)
Vedanta	3053	1,986	5,039	399	1.31	0.79
TSTPS-1	1509	677	2,186	219	1.45	1.00
FSTPS-I & II	-	1,542	1,542	132	-	0.86
FSTPS-III	-	586	586	91	-	1.54
KhTPS-I	-	880	880	96	-	1.09
KhTPS-II	-	269	269	30	-	1.13
Total	4,562	5,941	10,503	967	1.35	0.92

- The state has surrendered 5,941 MUs of power (17% of the total energy requirement in 2020-21)

Stranded Cost of Power Purchase : Madhya Pradesh

Breakup of Power Purchase Cost for FY 2019-20

Particulars	Energy Received by the Licensee	Variable Cost	Fixed Cost	Total Cost*	
Unit	MUs	Rs. Crore	Rs. Crore	Rs. Crore	Rs./Unit
Thermal	79,744	16,375	9,733	26,108	3.27
Hydro	5,798	-	1,343	1,343	2.32
Renewable	7,644	4,211	-	4,211	5.51
Others	2,282	673	-	673	2.95
Total Power purchase	95,468	21,259	11,076	32,335	3.39
Revenue for Surplus Power				9,888	
MPPMCL Cost				(730)	
Net Power Purchase Cost allowed	95,468	21,259	11,076	21,717	2.27

- Approved ARR for FY 2019-20 is Rs.32,797 Crore and PP Cost contributes 66 % of the ARR (excluding Transmission Charges).

Source : Tariff Order for FY 2019-20

* Per unit total cost has been estimated using input energy for the DISCOM

Stranded Cost of Power Purchase: Madhya Pradesh

Details of Surrendered Power for FY 2019-20

Particulars	Units	Value
Energy Requirement	MU	69,353
Energy Availability	MU	97,989
Energy Surrendered	MU	28,636
Fixed Cost of Surplus Energy	Rs. Crore	4,325
Actual Fixed Cost Per Unit Availed	Rs./Unit	1.11
Total Fixed Cost Per Unit	Rs./Unit	0.73

Details of surrendered power						
Generating Stations	Energy Received (MU)	Energy Surrendered (MU)	Total Energy	Fixed Cost (Rs Crore)	Per Unit Fixed Cost of Energy Availed (Rs./unit)	Per Unit Fixed Cost for Total Energy (Availed + Surrendered) (Rs./unit)
NTPC Stations	26947	7062	34010	3,141	1.17	0.92
IPP's	22815	19053	41868	2,396	1.05	0.57
Others		2521				
Total	49762	28636	75877	5537	1.11	0.73

- The surplus energy is around 29% of the energy availability
- As per the tariff order for 2019-20, the State Commission has approved sale of surplus energy (25,658 MU) through power exchange at Rs. 3.85/unit leading to an additional revenue of Rs.9,888 Crore.

Stranded Cost of Power Purchase: Madhya Pradesh

Ratio of Surplus Fixed Cost to ARR

Ratio of Surplus Fixed Cost to ARR		
Particulars	Units	
Approved Sales for FY 2019-20	MU	55,638
Approved ARR	Rs. Crore	32,796
Approved ACoS	Rs./Unit	5.89
Fixed Cost for Surplus Power	Rs. Crore	4,325
Ratio of Fixed Cost Paid to ARR	%	13.19%

Scenario - Power Purchase from Thermal instead of Renewables

Particulars	Energy(MU)	Total Cost(Rs. Crore)	Rs./Unit
Renewable Energy	7,464	4211	5.64
Purchase from Thermal Stations @ Variable Cost	7,464	1570	2.10
Net Savings	7,464	2,641	3.54

- Impact of surplus power on ACoS is around **78 paise/unit (13.19%)**
- Instead of procuring power from Renewables, if the DISCOM had procured power from thermal stations, it would have led to savings of **around Rs. 2,641 Crore (8% of ARR)**

Stranded Cost of Power Purchase : JBVNL, Jharkhand

Breakup of Power Purchase Cost for FY 2020-21

Particulars	Energy Received by the Licensee	Variable Cost	Fixed Cost	Total Cost	
Unit	MUs	Rs. Crore	Rs. Crore	Rs. Crore	Rs./Unit
Thermal	9,206	1,902	1,898	3,800	4.13
Hydro	910	154	53	208	2.28
Renewable	1,632	535	-	535	3.28
Total Power purchase	11,749	2,591	1,951	4,543	3.87

Particulars	Units	Value
Energy Availability*	MU	11,372
Energy Requirement	MU	11,372

- Approved ARR for FY 2020-21 is Rs.6,326 Crore and PP Cost contributes 72 % of the ARR (excluding Transmission Charges).

Source : Tariff Order for FY 2020-21

*The Commission has estimated energy availability for FY 2020-21 on the basis of actual generation from tied-up power from Central, State-owned and other Generating Stations

Stranded Cost of Power Purchase : JBVNL, Jharkhand

Ratio of Surplus Fixed Cost to ARR

Ratio of Surplus Fixed Cost to ARR		
Particulars	Units	
Approved Sales for FY 2020-21	MU	9,894
Approved ARR	Rs. Crore	6,326
Approved ACoS	Rs./Unit	6.39
Fixed Cost for Surplus Power	Rs. Crore	563
Ratio of Fixed Cost Paid to ARR	%	8.90%

Scenario -Power Purchase from Thermal Stations instead of Renewables

Particulars	Energy(MU)	Total Cost(Rs. Crore)	Rs./Unit
Renewable Energy	1,632	535	3.28
Purchase from Thermal Stations @ Variable Cost	1,632	337	2.07
Net Savings	1,632	198	1.21

- Impact of Surplus Power on ACoS is around **57 paise/unit (8.90%)**
- Instead of procuring power from Renewables, if the DISCOM had procured power from thermal stations , it would have led to savings of around **Rs. 198 Crore (3.1% of ARR)**

Stranded Cost of Power Purchase : Assam

Breakup of Power Purchase Cost for FY 2018-19

Particulars	Energy Received by the Licensee	Fixed Cost	Variable Cost	Other Cost	Total Cost	
Unit	MUs	Rs. Crore	Rs. Crore	Rs. Crore	Rs. Crore	Rs./Unit
Thermal	6,604	1,299	1,475		2,774	4.20
Hydro	1,541	202	220		421	2.74
Renewable	92	-	53		53	5.74
Others	1,493	4	641	51	696	4.66
Total Power purchase	9,730	1,505	2,388	51	3,944	4.05
Transmission Charges					1,161	
Less: Delayed Payment Surcharge					36	
Net Power Purchase Cost allowed	9,730	1,505	2,388	51	5,069	5.21

- Approved ARR for FY 2018-19 is Rs. 5,374 Crore and PP Cost contributes 94% of the ARR including Transmission Charges and 73 % excluding Transmission Charges.

Stranded Cost of Power Purchase: Assam

Details of Surrendered Power for FY 2018-19

Particulars	Units	Value
Energy Requirement	MU	8,866
Energy Availability	MU	9,730
Energy Surplus	MU	864
Fixed Cost of Surplus Energy	Rs. Crore	294*
Actual Per Unit Fixed Cost	Rs./Unit	3.40
Total Fixed Cost Per Unit	Rs./Unit	2.19

Ratio of Surplus Fixed Cost to ARR		
Particulars	Units	
Approved Sales for FY 2018-19	MU	6,968
Approved ARR	Rs. Crore	5,374
Approved ACoS	Rs./Unit	7.71
Fixed Cost for Surplus Power	Rs. Crore	294*
Ratio of Fixed Cost Paid to ARR	%	5.47%

- The Surplus Energy is around 9% of the energy availability; The income earned from the sale of Surplus Power is **Rs.171 Crore @ Rs. 1.97 per Unit.**
- Impact of Surplus Power on ACOS is around **42 paise/unit.**

Source : True up Order for FY 2018-19

*Computed based on assumptions

Stranded Cost of Power Purchase: Assam

Scenario Analysis-Contribution of Renewables

❑ **Scenario** -Power Purchase from Thermal instead of Renewables

Particulars	Energy(MU)	Total Cost(Rs. Crore)	Rs./Unit
Renewable Energy	92	53	5.74
Purchase from Thermal Stations @ Variable Cost	92	21	2.23
Net Savings	92	32	3.51

- Instead of procuring power from Renewables, if the DISCOM had procured power from thermal stations , it would have led to savings of around **Rs. 32 Crore (0.6% of the ARR)**

Stranded Cost of Power Purchase : Uttarakhand

Breakup of Power Purchase Cost for FY 2020-21

Particulars	Energy Received by the Licensee	Variable Cost	Fixed Cost	Total Cost	
				Unit	MUs
Thermal	6,225	1,991	734	3,800	4.13
Hydro	6,312	953	577	208	2.28
Renewable	1,477	672	-	535	3.28
Others	282	101	-		
Total Power purchase	14,295	3,717	1,311	5,028	3.52
Short Term (Tied Up) & Deficit Purchase	487	195			
Banking including OA Charges	49	30			
Net Power Purchase Cost allowed	14,832	3,942	1,311	5,252	3.54

Particulars	Units	Value
Energy Requirement	MU	14,832
Energy Availability	MU	14,295
Energy Deficit	MU	536

- Approved ARR for FY 2020-21 is Rs.6,957 Crore and PP Cost contributes 75% of the ARR.

Stranded Cost of Power Purchase: Uttarakhand

Scenario Analysis-Contribution of Renewables

❑ Scenario - Power Purchase from Thermal instead of Renewables

Particulars	Energy(MU)	Total Cost(Rs. Crore)	Rs./Unit
Renewable Energy	1,477	672	4.55
Purchase from Thermal Stations @ Variable Cost	1,477	472	3.20
Net Savings	1,477	200	1.35

- Instead of procuring power from Renewables, if the DISCOM had procured power from Thermal Stations , it would have led to savings of around **Rs. 200 Crore (2.8% of ARR)**

Stranded Cost of Power Purchase: Bihar

Breakup of Power Purchase Cost for FY 2020-21

Particulars	Energy Received by the Licensee	Fixed Cost	Variable Cost	Other Cost	Total Cost	
Unit	MUs	Rs. Crore	Rs. Crore	Rs. Crore	Rs. Crore	Rs./Unit
Thermal	25,425	5,489	5,552	135	11,175	4.40
Hydro	3,117	150	833		983	3.15
Renewable	3,026	-	1,084		1,084	3.58
Others	816	-	342		342	4.19
Total Power purchase	32,384	5,639	7,811	135	13,584	4.19

- Approved ARR for FY 2020-21 is Rs. 18,528 Crore and PP Cost contributes 73% of the ARR excluding Transmission Charges

Stranded Cost of Power Purchase: Bihar

Details of Surrendered Power for FY 2020-21

Particulars	Units	Value
Energy Requirement	MU	32,384
Energy Availability	MU	46,686
Energy Surplus	MU	14,301
Fixed Cost of Surplus Energy	Rs. Crore	1,294*
Actual Fixed Cost Per Unit Availed	Rs./Unit	1.95
Total Fixed Cost Per Unit	Rs./Unit	1.26

Details of surrendered power						
Generating Stations	Energy Received (MU)	Energy Surrendered (MU)	Total Energy	Fixed Cost (Rs Crore)	Per Unit Fixed Cost of Energy Availed (Rs./unit)	Per Unit Fixed Cost for Total Energy (Availed + Surrendered) (Rs./unit)
CGS	22398	11507	33905	4311	1.92	1.27
SGS	3484	2794	6278	742	2.13	1.18
Total	25882	14301	40183	5053	1.95	1.26

- The surplus energy is around 31% of the energy availability,

*Computed on the basis of Station wise Surplus Energy

Source : Tariff Order for FY 2020-21

Stranded Cost of Power Purchase: Bihar

Scenario Analysis

Ratio of Surplus Fixed Cost to ARR		
Particulars	Units	
Approved Sales	MU	26,499
Approved ARR	Rs. Crore	18,528
Approved ACoS	Rs./Unit	6.99
Fixed Cost for Surplus Power	Rs. Crore	1,294*
Ratio of Fixed Cost Paid to ARR	%	6.99%

❑ Scenario - Power Purchase from Thermal instead of Renewables

Particulars	Energy(MU)	Total Cost(Rs. Crore)	Rs./Unit
Renewable Energy	3,026	1,084	3.58
Purchase from Thermal Stations @ Variable Cost	3,026	661	2.18
Net Savings	3,026	423	1.40

- Impact of surplus power on ACOS is around 6.99% (48 paise/unit)
- Instead of procuring power from Renewables, if the DISCOM had procured power from Thermal Stations , it would have led to savings of around Rs. 423 Crore.

Stranded Cost of Power Purchase: Uttar Pradesh

Breakup of Power Purchase Cost for FY 2020-21

Particulars	Energy Received by the Licensee	Fixed Cost	Variable Cost	Total Cost	
Unit	MUs	Rs. Crore	Rs. Crore	Rs. Crore	Rs./Unit
Thermal	101,328	19,863	24,366	44,229	4.36
Hydro	13,899	2,911	2,476	5,387	3.88
Renewable	7,523	-	3,088	3,088	4.10
Others	8,994	-	605	605	0.67
Total Power purchase	131,744	22,774	30,535	53,309	4.05

- Approved ARR for FY 2020-21 is Rs. 65,175 Crore and PP Cost contributes 82% of the ARR excluding Transmission Charges

Stranded Cost of Power Purchase: Uttar Pradesh

Details of Surrendered Power for FY 2020-21

Particulars	Units	Value
Energy Requirement	MU	1,09,328
Energy Availability	MU	1,31,744
Energy Surplus	MU	22,416
Fixed Cost of Surplus Energy	Rs. Crore	4394*
Actual Per Unit Fixed Cost	Rs./Unit	1.96
Total Fixed Cost Per Unit	Rs./Unit	1.61

Ratio of Surplus Fixed Cost to ARR		
Particulars	Units	
Approved Sales	MU	92,409
Approved ARR	Rs. Crore	65,175
Approved ACoS	Rs./Unit	7.05
Fixed Cost for Surplus Power	Rs. Crore	4,394*
Ratio of Fixed Cost Paid to ARR	%	6.74%

- The surplus energy is around 17% of the energy availability,
- Impact of surplus power on ACOS is 6.74% (47 paise/unit)

*Computed on the basis of Fixed Cost per Unit of Thermal Energy

Source : Tariff Order for FY 2020-21

Stranded Cost of Power Purchase: Uttar Pradesh

Scenario Analysis

❑ Scenario- Power Purchase from Thermal instead of Renewables

Particulars	Energy(MU)	Total Cost(Rs. Crore)	Rs./Unit
Renewable Energy	7,523	3,088	4.10
Purchase from Thermal Stations @ Variable Cost	7,523	1,809	2.40
Net Savings	7,523	1,279	1.70

- Instead of procuring power from Renewables, if the DISCOM had procured power from Thermal Stations , it would have led to savings of around Rs. 1279 Crore.

Stranded Cost of Power Purchase : Haryana

Breakup of Power Purchase Cost for FY 2020-21

Particulars	Energy Received by the Licensee	Fixed Cost	Variable Cost	Total Cost	
Unit	MUs	Rs. Crore	Rs. Crore	Rs. Crore	Rs./Unit
Thermal	51,354	5,937	15,554	21,491	4.18
Hydro	7,984	912	1,273	2,185	2.74
Renewable	3,588	-	1,251	1,251	3.49
Others	740	4	273	276	3.73
Total Power purchase	63,667	6,852	18,351	25,203	3.96
Approved PP Cost				20,868	3.28

- Approved ARR for FY 2020-21 is Rs. 27,836 Crore and PP Cost contributes 75% of the ARR excluding Transmission Charges

Stranded Cost of Power Purchase: Haryana

Details of Surrendered Power for FY 2020-21

Particulars	Units	Value
Energy Requirement	MU	48,796
Energy Availability	MU	63,667
Energy Surplus	MU	14,870
Fixed Cost of Surplus Energy	Rs. Crore	1719*
Actual Per Unit Fixed Cost	Rs./Unit	1.16
Total Fixed Cost Per Unit	Rs./Unit	0.90

Ratio of Surplus Fixed Cost to ARR		
Particulars	Units	
Approved Sales	MU	38,474
Approved ARR	Rs. Crore	27,836
Approved ACoS	Rs./Unit	7.23
Fixed Cost for Surplus Power	Rs. Crore	1719*
Ratio of Fixed Cost Paid to ARR	%	6.18%

- The surplus energy is around 23% of the energy availability,
- Impact of surplus power on ACOS is 6.18% (45 paise/unit)

*Computed on the basis of Fixed Cost per Unit of Thermal Energy

Source : Tariff Order for FY 2020-21

Stranded Cost of Power Purchase: Haryana

Scenario Analysis

❑ Scenario -Power Purchase from Thermal instead of Renewables

Particulars	Energy(MU)	Total Cost(Rs. Crore)	Rs./Unit
Renewable Energy	3,588	1,251	3.49
Purchase from Thermal Stations @ Variable Cost	3,588	1,087	3.03
Net Savings	3,588	165	0.46

- Instead of procuring power from Renewables, if the DISCOM had procured power from Thermal Stations , it would have led to savings of around Rs. 165 Crore.

Stranded Cost of Power Purchase : Andhra Pradesh

Breakup of Power Purchase Cost for FY 2020-21

Particulars	Energy Received by the Licensee	Fixed Cost	Variable Cost	Total Cost	
Unit	MUs	Rs. Crore	Rs. Crore	Rs. Crore	Rs./Unit
Thermal	50,545	7,894	16,016	23,910	4.73
Hydro	3,169	601	-	601	1.90
Renewable	14,392	-	6,597	6,597	4.58
Others	795	984	175	1,159	14.57
Total Power purchase	68,902	9,479	22,788	32,268	4.68

- Approved ARR for FY 2020-21 is Rs. 42,494 Crore and PP Cost contributes 76% of the ARR excluding Transmission Charges

Stranded Cost of Power Purchase: Andhra Pradesh

Details of Surrendered Power for FY 2020-21

Particulars	Units	Value
Energy Requirement	MU	68,902
Energy Availability	MU	78,406
Energy Surplus	MU	9,504
Fixed Cost of Surplus Energy	Rs. Crore	917*
Actual Fixed Cost Per Unit Availed	Rs./Unit	2.41
Total Fixed Cost Per Unit	Rs./Unit	1.88

Details of surrendered power						
Generating Stations	Energy Received (MU)	Energy Surrendered (MU)	Total Energy (MU)	Fixed Cost (Rs Crore)	Per Unit Fixed Cost of Energy Availed (Rs./unit)	Total Per Unit Fixed Cost (Rs./unit)
NTPC Stations	21510	7928	29437	5048	2.35	1.71
IPP's	12017	1577	13594	3043	2.53	2.24
Total	33527	9504	43031	8090	2.41	1.88

- The surplus energy is around 12% of the energy availability,

*Computed on the basis of Fixed Cost per Unit of Station wise Thermal Energy

Source : Tariff Order for FY 2020-21

Stranded Cost of Power Purchase: Andhra Pradesh

Scenario Analysis

Ratio of Surplus Fixed Cost to ARR		
Particulars	Units	
Approved Sales	MU	61,819
Approved ARR	Rs. Crore	42,494
Approved ACoS	Rs./Unit	6.87
Fixed Cost for Surplus Power	Rs. Crore	917*
Ratio of Fixed Cost Paid to ARR	%	2.16%

Scenario - Power Purchase from Thermal instead of Renewables

Particulars	Energy(MU)	Total Cost(Rs. Crore)	Rs./Unit
Renewable Energy	14,392	6,597	4.58
Purchase from Thermal Stations @ Variable Cost	14,392	4,560	3.17
Net Savings	14,392	2,037	1.42

- Impact of surplus power on ACOS is 2.16% (14 paise/unit)
- Instead of procuring power from Renewables, if the DISCOM had procured power from Thermal Stations , it would have led to savings of around Rs. 2037 Crore.

Stranded Cost of Power Purchase : Gujarat

Breakup of Power Purchase Cost for FY 2020-21

Particulars	Energy Received by the Licensee	Fixed Cost	Variable Cost	Total Cost	
Unit	MUs	Rs. Crore	Rs. Crore	Rs. Crore	Rs./Unit
Thermal	88,217	12,017	19,173	31,190	3.54
Hydro	599	115	-	115	1.92
Renewable	16,533	40	6,813	6,853	4.15
Others	302	-	121	121	4.02
Total Power purchase	105,652	12,173	26,105	38,277	3.62

- Approved ARR for FY 2020-21 is Rs. 51,712 Crore and PP Cost contributes 74% of the ARR excluding Transmission Charges

Stranded Cost of Power Purchase: Gujarat

Details of Surrendered Power for FY 2020-21

Particulars	Units	Value
Energy Requirement	MU	1,05,652
Energy Availability	MU	1,16,872
Energy Surplus	MU	11,220
Fixed Cost of Surplus Energy	Rs. Crore	1,528*
Actual Per Unit Fixed Cost	Rs./Unit	1.36
Total Fixed Cost Per Unit	Rs./Unit	1.21

Ratio of Surplus Fixed Cost to ARR		
Particulars	Units	
Approved Sales	MU	87,824
Approved ARR	Rs. Crore	51,712
Approved ACoS	Rs./Unit	5.89
Fixed Cost for Surplus Power	Rs. Crore	1,528*
Ratio of Fixed Cost Paid to ARR	%	2.96%

- The surplus energy is around 10% of the energy availability,
- Impact of surplus power on ACOS is 2.96% (17 paise/unit)

*Computed on the basis of Fixed Cost per Unit of Thermal Energy

Source : MTR for FY 2019-20 to FY 2020-21

Stranded Cost of Power Purchase: Gujarat

Scenario Analysis

❑ Scenario - Power Purchase from Thermal instead of Renewables

Particulars	Energy(MU)	Total Cost(Rs. Crore)	Rs./Unit
Renewable Energy	16,533	6,853	4.15
Purchase from Thermal Stations @ Variable Cost	16,533	3,593	2.17
Net Savings	16,533	3,260	1.97

- Instead of procuring power from Renewables, if the DISCOM had procured power from Thermal Stations , it would have led to savings of around Rs. 3260 Crore.

Stranded Cost of Power Purchase : Kerala

Breakup of Power Purchase Cost for FY 2020-21

Particulars	Energy Received by the Licensee	Fixed Cost	Variable Cost	Other Cost	Total Cost	
Unit	MUs	Rs. Crore	Rs. Crore	Rs. Crore	Rs. Crore	Rs./Unit
Thermal	19,975	3,090	5,293	(119)	8,264	4.14
Hydro	88	-	-		31	3.48
Renewable	1,397	-	-		384	2.75
Others	385	-	-		216	5.62
Total Power purchase	21,845	3,090	5,293	(119)	8,895	4.07

- Approved ARR for FY 2020-21 is Rs. 15,936 Crore and PP Cost contributes 56% of the ARR excluding Transmission Charges

Stranded Cost of Power Purchase: Kerala

Details of Surrendered Power for FY 2020-21

Particulars	Units	Value
Energy Requirement	MU	26,674
Energy Availability	MU	27,456
Energy Surplus	MU	782
Fixed Cost of Surplus Energy	Rs. Crore	121*
Actual Per Unit Fixed Cost	Rs./Unit	1.55
Total Fixed Cost Per Unit	Rs./Unit	1.49

Ratio of Surplus Fixed Cost to ARR		
Particulars	Units	
Approved Sales	MU	23,454
Approved ARR	Rs. Crore	15,936
Approved ACoS	Rs./Unit	6.77
Fixed Cost for Surplus Power	Rs. Crore	121*
Ratio of Fixed Cost Paid to ARR	%	0.76%

- The Surplus Energy is around 3% of the Energy Availability;
- Impact of Surplus Power on ACOS is 0.76%.

Stranded Cost of Power Purchase: Kerala

Scenario Analysis

❑ Scenario -Power Purchase from Thermal instead of Renewables

Particulars	Energy(MU)	Total Cost(Rs. Crore)	Rs./Unit
Renewable Energy	1,397	384	2.75
Purchase from Thermal Stations @ Variable Cost	1,397	370	2.65
Net Savings	1,397	14	0.10

- Instead of procuring power from Renewables, if the DISCOM had procured power from Thermal Stations , it would have led to savings of around Rs. 14 Crore.

Stranded Cost of Power Purchase: Summary

Ratio of Fixed Cost Paid to ARR

Ratio of Surplus Fixed Cost to ARR			
State	Year	Fixed Cost Paid for Surplus Power (in Rs. Crore)	Ratio of Fixed Cost Paid to ARR (in %)
Madhya Pradesh	FY 2019-20	4,325	13.2%
Jharkhand	FY 2020-21	563	8.9%
Bihar	FY 2020-21	1,294	7.0%
Uttar Pradesh	FY 2020-21	4,394	6.7%
Haryana	FY 2020-21	1,719	6.2%
Assam	FY 2018-19	294	5.5%
Punjab	FY 2018-19	977	3.2%
Odisha	FY 2020-21	348	3.1%
Gujarat	FY 2020-21	1,528	3.0%
Andhra Pradesh	FY 2020-21	917	2.2%
Kerala	FY 2020-21	121	0.8%
Total		16480	

- Fixed cost paid for surplus power varied in the range of 1-13% of the total ARR for the 12 states

Summary: Under-utilization of generating stations

Hypothesis: Optimal utilization of TPPs may lead to reduction in electricity tariffs

- ❑ Under-utilization of generating stations could be attributed to shortage of coal, non-compliance with Merit Order Dispatch, procurement from RE sources, and generating plants running on technical minimum due to higher energy availability.
- ❑ In Punjab, operation of State Thermal Power Plants at lower PLF has led to a normative loss of **Rs. 672 Crore** in addition to the fixed charges paid for surplus power.
- ❑ Fixed cost paid for surplus power varied in the range of **1-13% of the total ARR** for the 12 states

Study on Analysis of **Key Factors Impacting** **Electricity Tariffs**

April 2021



Contents

01

Background and objective

02

Structure of the discussion

03

Analysis of select parameters

04

Conclusion

Background and objective

- ❑ Retail supply tariffs are designed to recover the cost incurred across the entire value chain i.e., generation, transmission, distribution and retail supply.
- ❑ It depends on multiple factors such as like cost of generation- fixed costs including O&M expenses, fuel expense, taxes and duties, etc., cost of transmission- capital and operating costs, Return on Equity (ROE), network maintenance expenses, etc. and cost of distribution- network development, O&M, distribution losses, metering, billing & collection expenses, etc.
- ❑ In order to identify measures to reduce retail supply tariffs, it is proposed to conduct a study on “**Analysis of key factors impacting electricity tariffs**”.

The proposed study will:

- a) Identify the impact of key external and internal factors on electricity tariff including the likely impact of recent developments in the sector, and
- b) Suggest policy and regulatory measures to reduce electricity tariffs

Structure of discussion

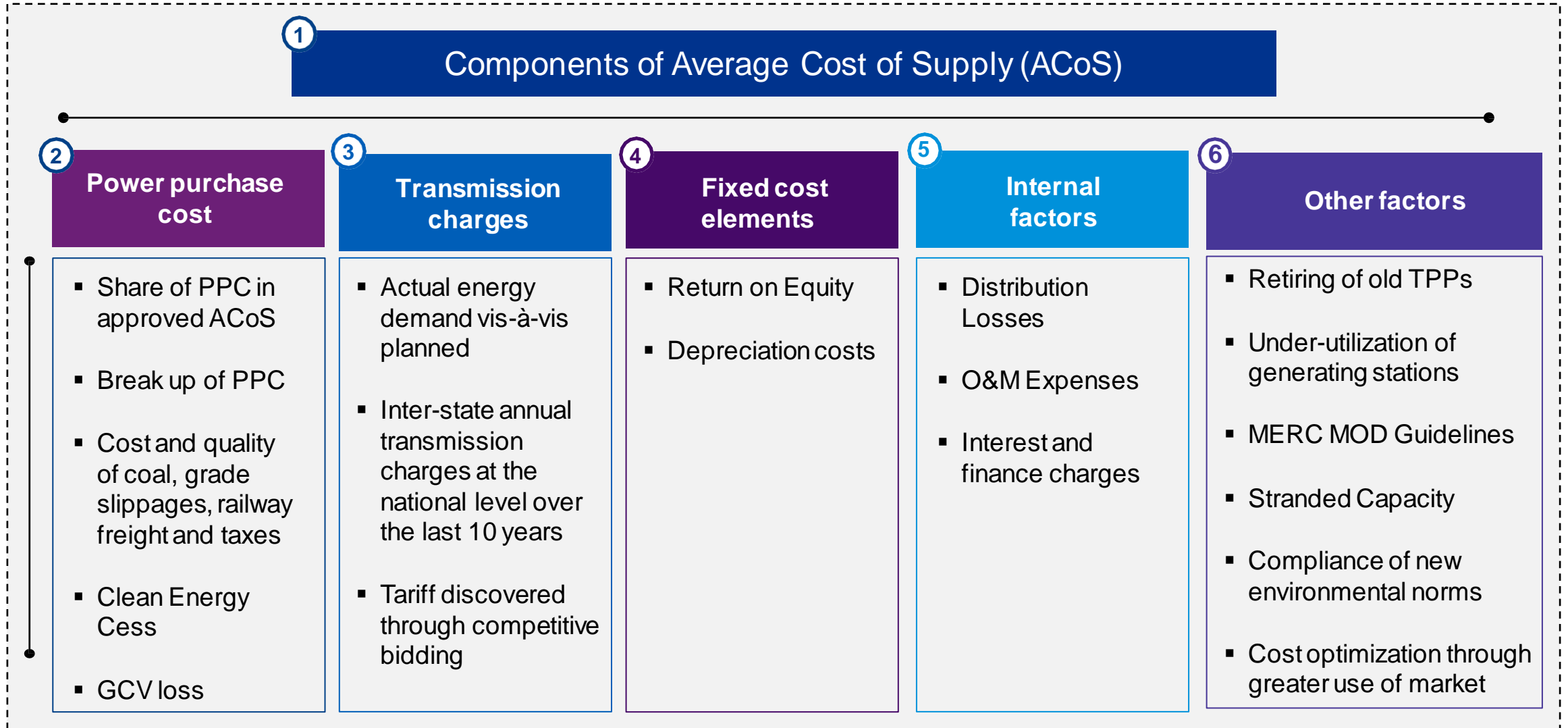

Power purchase cost



Share of PPC in approved ACoS



Power purchase trend

Hypothesis: PPC constitutes major share of ACoS and the share has not increased over the last 4 years

❑ PPC (excluding transmission charges) accounts for ~67% to 78% of the total ACoS for 12 states* over the last 4 years

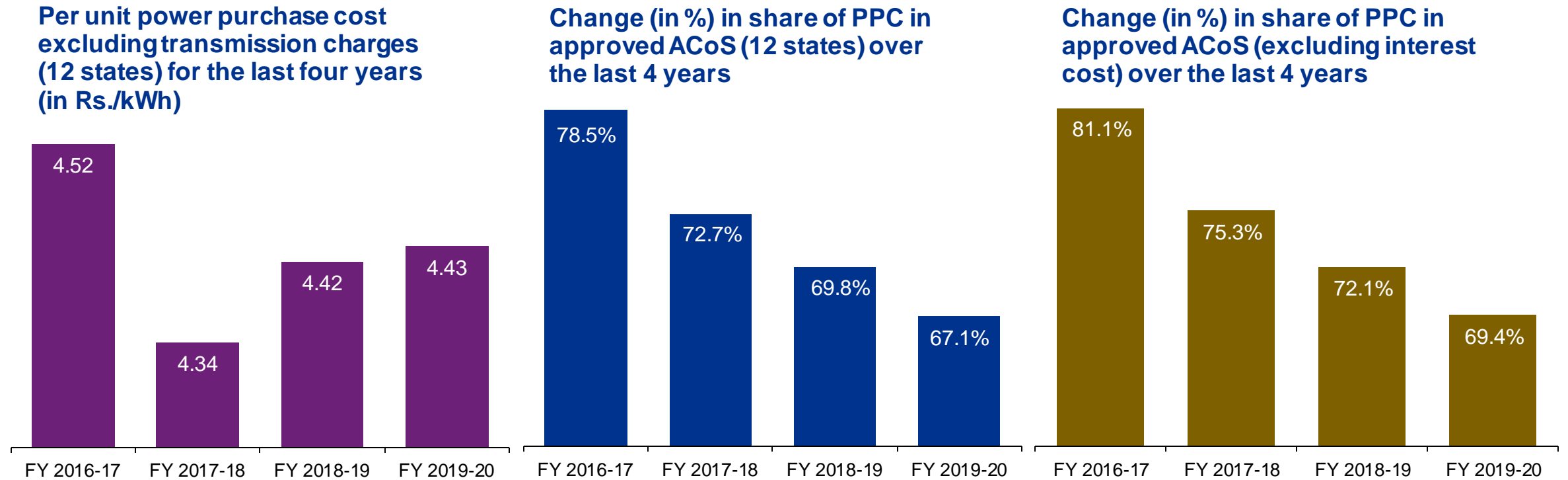

The power purchase costs has reduced marginally over the last 4 years. The share of PPC in approved ACoS has reduced from 78% to 67%.

Source: Tariff orders issued by respective state commissions for the last 5 years

State-wise PPC excluding TC for last 4 years

Approved ACoS ABR gap for last 4 years

*The selected 12 states identified in consultation with the FOR account for 50% of the total consumption in the country

Share of cost components (in %) of ARR

Change in share of cost components over the last 4 years

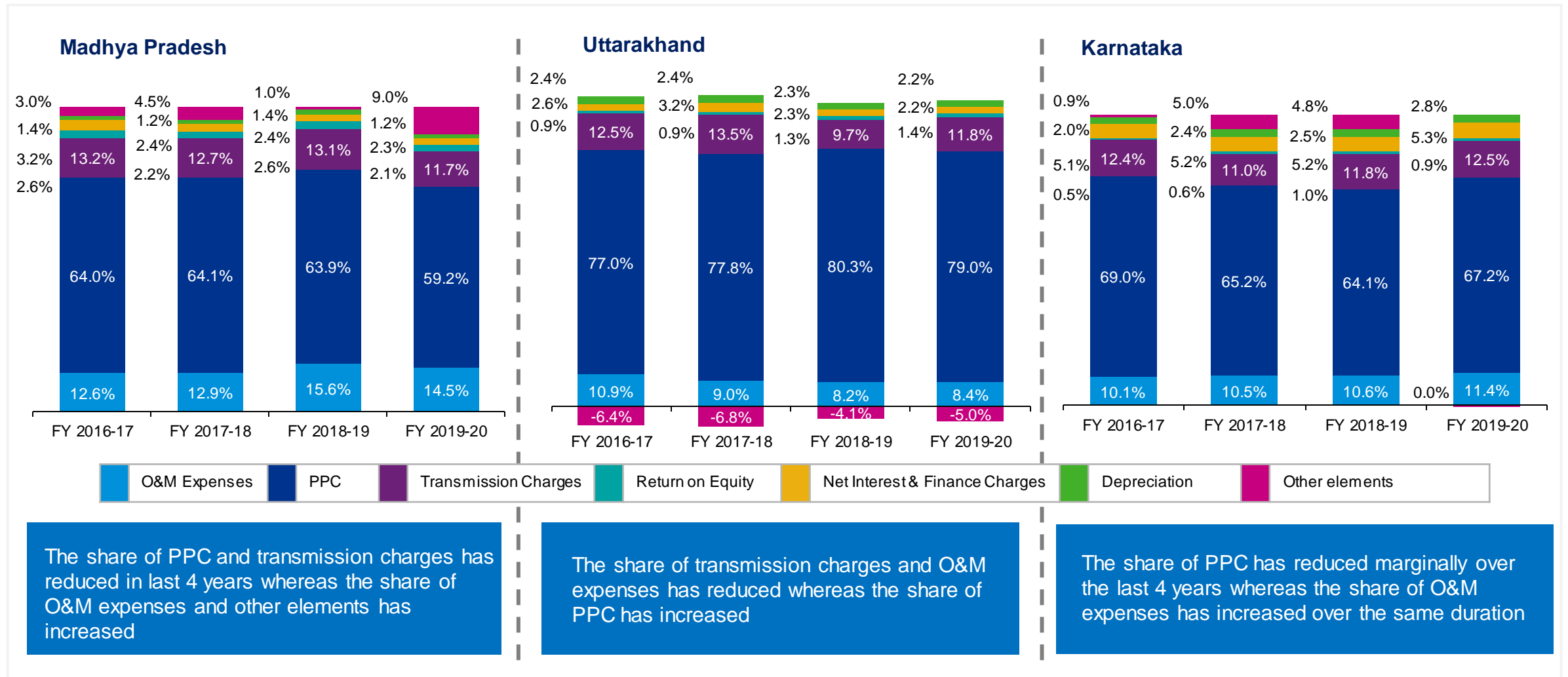

Source: Tariff orders issued by respective state commissions for the last 4 years;

Share of cost components (in %) of ARR

Change in share of cost components over the last 4 years

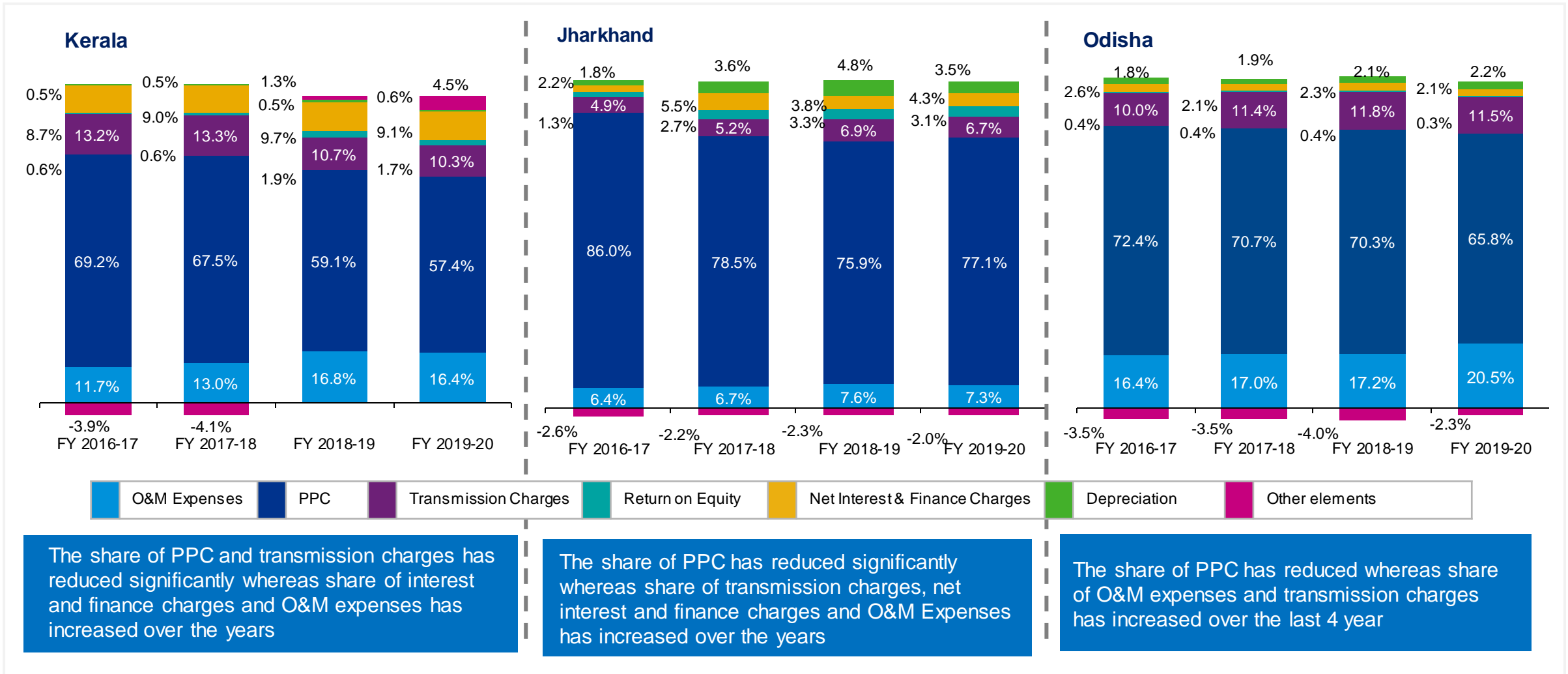

Source: Tariff orders issued by respective state commissions for the last 4 years;

Share of cost components (in %) of ARR

Change in share of cost components over the last 4 years

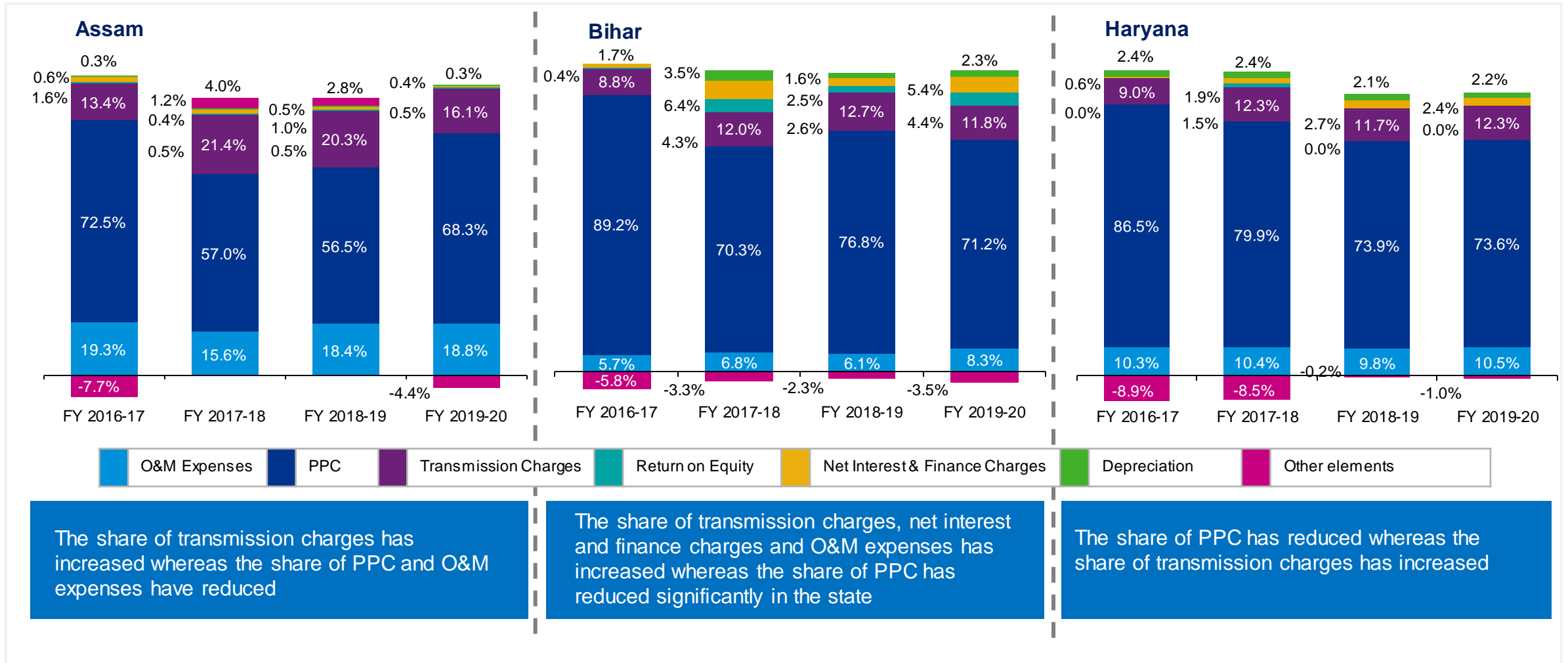

Source: Tariff orders issued by respective state commissions for the last 4 years;

Share of cost components (in %) of ARR

Change in share of cost components over the last 4 years

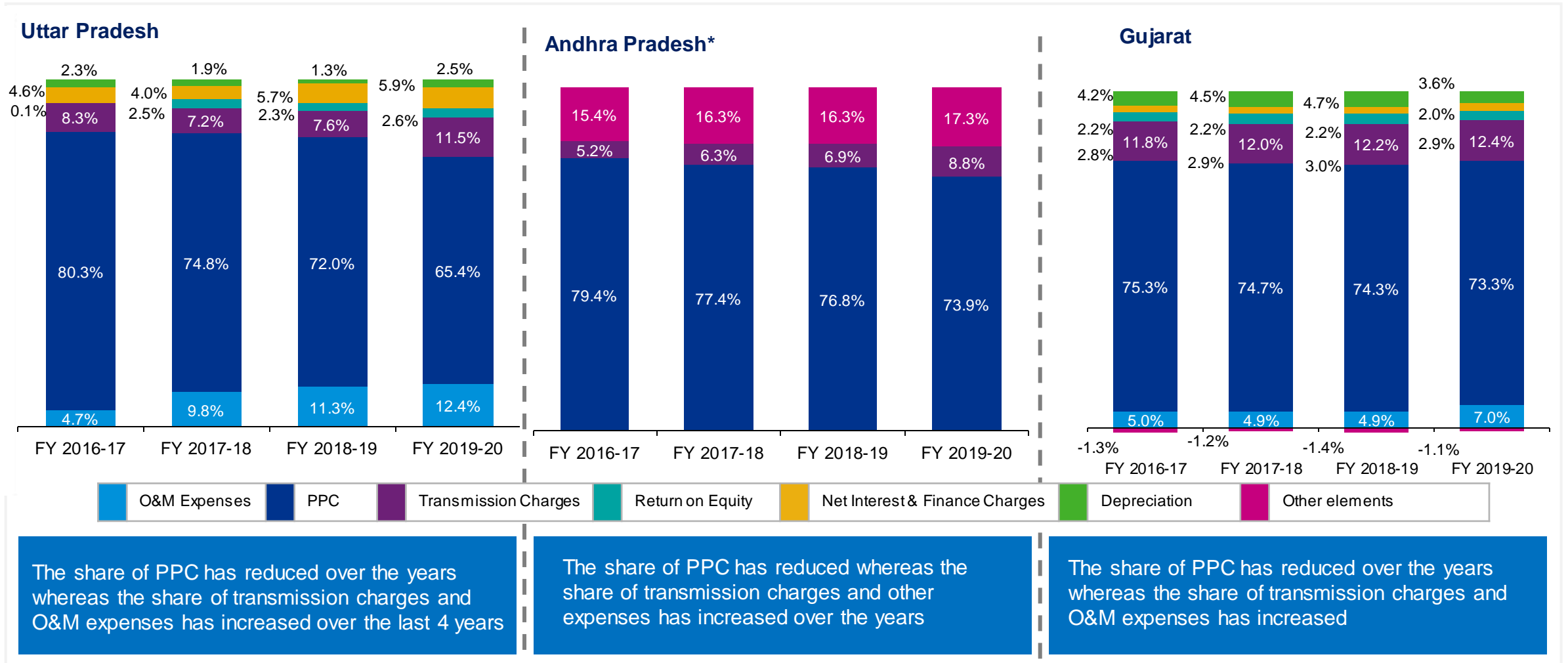

*For the state of Andhra Pradesh, net ARR is estimated as sum of PPC, transmission charges and other elements of ARR

Source: Tariff orders issued by respective state commissions for the last 4 years;

Summary: Power purchase trend

Hypothesis: PPC constitutes major share of ACoS and the share has not increased over the last 4 years

- ❑ PPC accounted for **~67% to 78% of the ACoS** over the last 4 years for 12 states. However, per unit PPC has reduced during the same period.
 - Share of PPC in approved ACoS has reduced across states (except for the states of Uttarakhand)
 - In Uttarakhand, the share of PPC has increased mainly on account of new PPAs with gas-based power plants

- ❑ Major reason for reduction in share of PPC is the **increase in contribution of other cost components** (such as O&M costs, depreciation, ROE, etc.) to the approved ACoS

**Power purchase break-up,
cost and quality of coal,
grade slippages, increasing
taxes, railway freight**



Power purchase break up for Madhya Pradesh for FY 2018-19

❑ PPC (excluding transmission charges) accounts for ~64% of the total ARR for FY 2018-19

Particular	Allocation (MW)	Quantum (MU)	FC* (Rs. Crore)	VC* (Rs. Crore)	FC* (Rs./ kWh)	VC* (Rs./ kWh)	Total Cost (Rs. Crore)	Total Cost* (Rs./kWh)
Central Sector	4,753	23,212	2,801	3,957	1.21	1.70	6,758	2.91
State Sector	12,080	55,213	7,064	8,497	1.28	1.54	15,561	2.82
Renewables	3,687	6,041	-	3,338	-	5.53	3,338	5.53
Others	55	99	4	-	0.40	0.00	4	0.40
Surplus Power	-	18,716	-	-	-	-	(4,866)	(2.60)
Revenue for SEZ	-	-	-	-	-	-	(28)	-
MPPMCL Cost	-	-	-	-	-	-	(480)	-
Total Power Purchase Cost	20,575	103,282	9,869	15,792	0.96	1.53	20,287	1.96

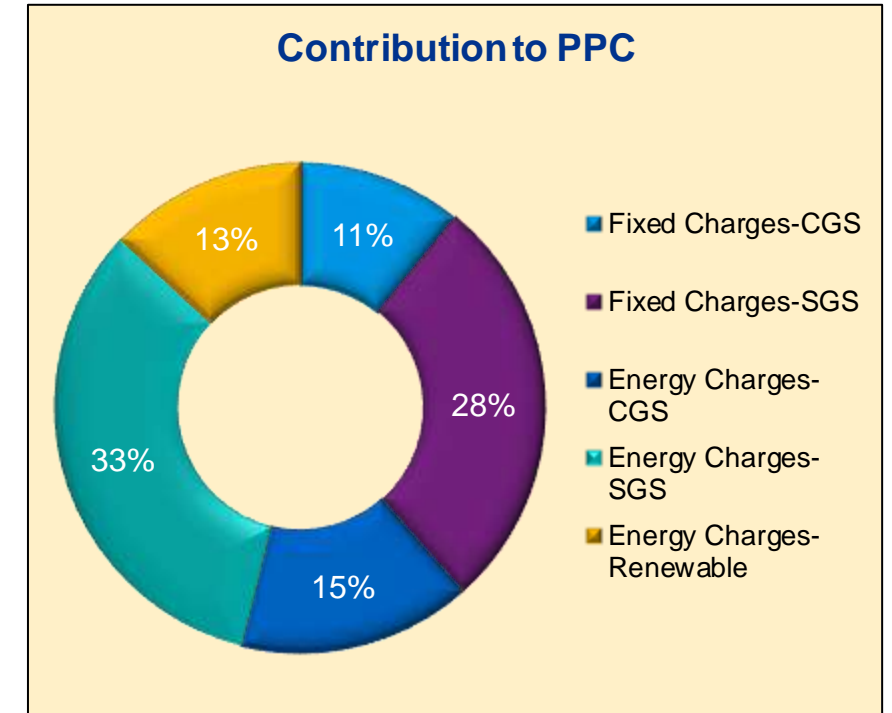

- Fixed charges contributed about 40% of PPC and energy charges contributed about 60%
- In the overall ARR, fixed charges contribute around 25% and energy charges contribute around 39% of ARR

Power purchase break up for Uttarakhand for FY 2018-19

❑ PPC (excluding transmission charges) accounts for ~80% of the total ARR for FY 2018-19

Particular	Allocation (MW)	PP at State periphery (MU)	FC* (Rs. Crore)	VC* (Rs. Crore)	VC* (Rs./kWh)	Total Cost (Rs. Crore)	Total Cost* (Rs./kWh)
Central Sector	1,018	4,926	569	1,033	2.10	1,602	3.25
State Sector	1,682	7,511	642	1,606	2.14	2,248	2.99
Renewables	209	1,989	-	701	3.53	701	3.53
Water Tax	-	-	-	233	-	233	-
Total Power Purchase Cost	2,909	14,426	1,212	3,573	2.48	4,785	3.32

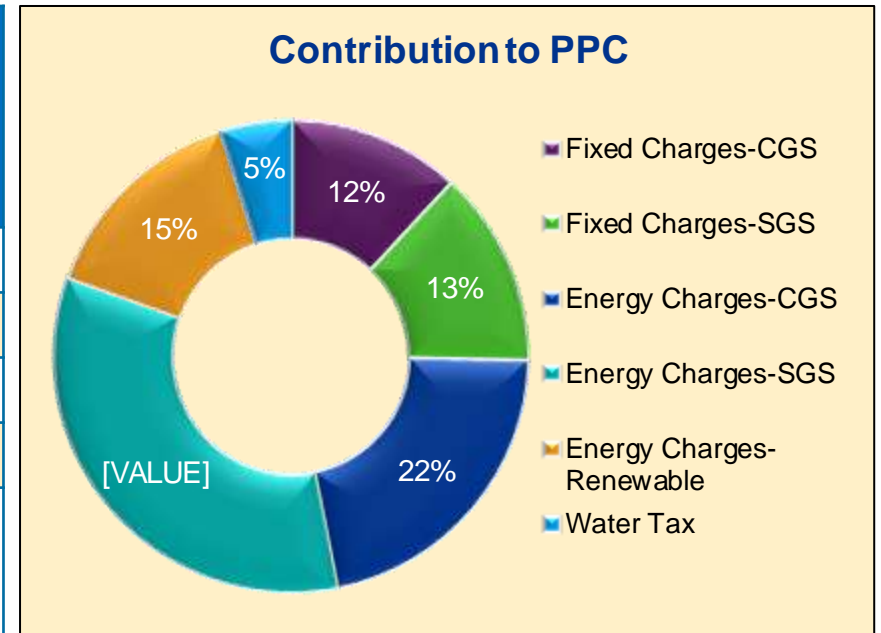

- Fixed charges contributed around 25% of PPC and energy charges contributed about 70% to PPC
- Variable charges for Uttarakhand is high mainly due to purchase from gas-based stations

Source: Tariff Order issued by UERC for FY 2018-19

*Total Cost per unit of Power Purchase (Rs./kWh)
FC: Fixed Charges, VC: Energy Charges

Coal price hike

Hypothesis: Cost of coal for TPPs has increased disproportionately as compared to other cost components

- Price per tonne for most grades of coal has increased since January 2018, directly impacting power purchase cost of power distribution companies

Coal Grade	GCV (Kcal/Kg)	Coal Price (Rs/Tonne)		
		June 2013- May 2016	June 2016- Dec 2017	Jan 2018- present
G1	Above 7000	Price shall be increased by Rs. 150/- per tonne over and above the price applicable for GCV band exceeding 6700 but not exceeding 7000 Kcal/Kg, for increase in GCV by every 100 Kcal/Kg		Price shall be increased by Rs. 100/- per tonne over and above the price applicable for GCV band exceeding 6700 but not exceeding 7000 Kcal/Kg, for increase in GCV by every 100 Kcal/Kg
G2	6701-7000	4,870	3,450	3,288
G3	6401-6700	3,890	3,210	3,144
G4	6101-6400	3,490	3,000	3,000
G5	5801-6100	2,800	2,750	2,737
G6	5501-5800	1,600	1,900	2,317
G7	5201-5500	1,400	1,600	1,926
G8	4901-5200	1,250	1,420	1,465
G9	4601-4900	970	1,100	1,140
G10	4301-4600	860	980	1,024
G11	4001-4300	700	810	955
G12	3701-4000	660	760	886
G13	3401-3700	610	720	817
G14	3101-3400	550	650	748
G15	2801-3100	510	600	590
G16	2501-2800	450	530	504
G17	2201-2500	400	470	447

- Increase in G11 – G14 Grade in Jan 2018 with respect to June 2016 is in range of 13-18%

Coal grade used for electricity generation

Railway transportation charges

Base freight charges of coal and coke have increased by 21% in Jan 2018 and 9% in Nov 2018 impacting the power purchase cost

Freight rate- Trainload for Coal and coke

Figures in Rs./tonne

Distance slab (in kms)	2016	July-sept 2017	Oct 2017-Jan 2018	Jan 2018*	November 2018#
1-100	165	179	165	199	216
500-600	844	949	935	1129	1228
1000-1020	1371	1476	1462	1765	1920
1500-1510	1970	2076	2061	2489	2707
2000-2010	2249	2354	2340	2825	3073
2500-2510	2524	2630	2615	3158	3434
3000-3010	2799	2905	2890	3490	3795

*Adjustment in base freight rates effective from 9th January 2018

Source: <http://www.indianrailways.gov.in>

#http://www.indianrailways.gov.in/railwayboard/uploads/directorate/traffic_comm/downloads/Freight_Rate_2018/RC_19_2018.PDF

Indicative coal prices and railway freight

Comparison of actual coal prices and railway freight vis-à-vis indicative prices linked to inflation

Comparison of actual coal prices (in Rs./Tonne) vis-à-vis indicative prices linked to inflation

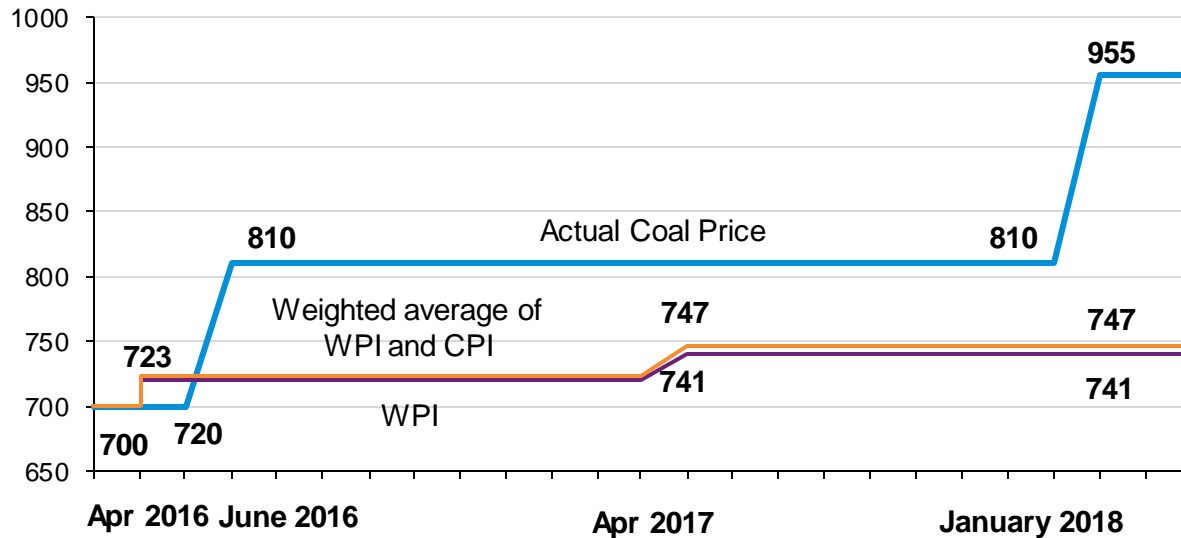

Comparison of actual railway freight (in Rs./Tonne) vis-à-vis indicative prices linked to inflation

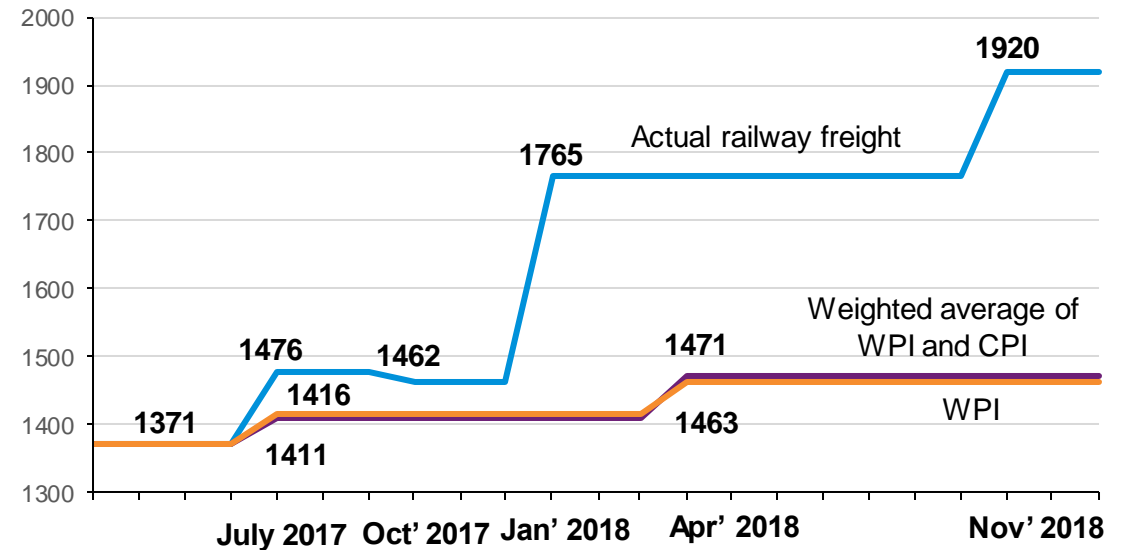

- Actual coal prices were about ~28% higher in Jan' 2018 as compared to price based on WPI and wt. avg. of WPI & CPI

- Actual railway freight was about ~30% higher in Nov' 2018 as compared to freight based on WPI and wt. avg. of WPI & CPI

Railway freight for distance slab 1000-1020 km considered for the analysis

Source: Inflation Rate: WPI index (<https://rbidocs.rbi.org.in/rdocs/AnnualReport/PDFs/4TCE9C7C09660A43A7824384F0E4661D7F.PDF>)

O&M charges (<http://www.cercind.gov.in/2020/orders/496-TT-2019.pdf>)

Clean energy cess

Description	Unit	Gol, Ministry of Finance Notification dated 22 June 2010	Gol, Ministry of Finance Notification dated July 2014	Gol, Ministry of Finance Notification dated 28 Feb 2015	Gol, Ministry of Finance Notification dated March 2016
Clean energy cess	Rs./Tonne	50	100	200	400

Source: <http://www.coal.nic.in>, www.arthapedia.in

https://coal.nic.in/sites/upload_files/coal/files/curentnotices/cbec140710_0_0.pdf <https://timesofindia.indiatimes.com/budget-2016/industry/Union-Budget-2016-Govt-doubles-Clean-Energy-Cess-on-coal-to-Rs-400-per-tonne/articleshow/51191619.cms> Source: <http://www.indianrailways.gov.in>

Clean Energy Cess

Clean Energy Cess considering Coal Consumption by Energy Sector

Year	Coal Consumption	Total Clean Energy Cess
	Million MT	Rs. Crore
2010-11	396	990
2011-12	438	2,188
2012-13	485	2,427
2013-14	493	2,466
2014-15	498	3,733
2015-16	518	9,492
2016-17	535	19,618
2017-18*	608	24,320
2018-19*	629	25,144
2019-20*	622	24,883

Notification	June 2010	July 2014	Feb. 2015	March 2016
Clean Energy Cess(Rs./Tonne)	50	100	200	400

- The total amount collected on account of clean energy cess has increased significantly since 2014-15 mainly on account of increase in coal consumption and increase in Cess (Rs./MT).

Source : MOSPI (Energy Statistics 2019)

*Computed based on Monthly CEA Fuel Reports

Contribution of fuel cost, railway freight and cess to cost of generation for a sample station in Madhya Pradesh

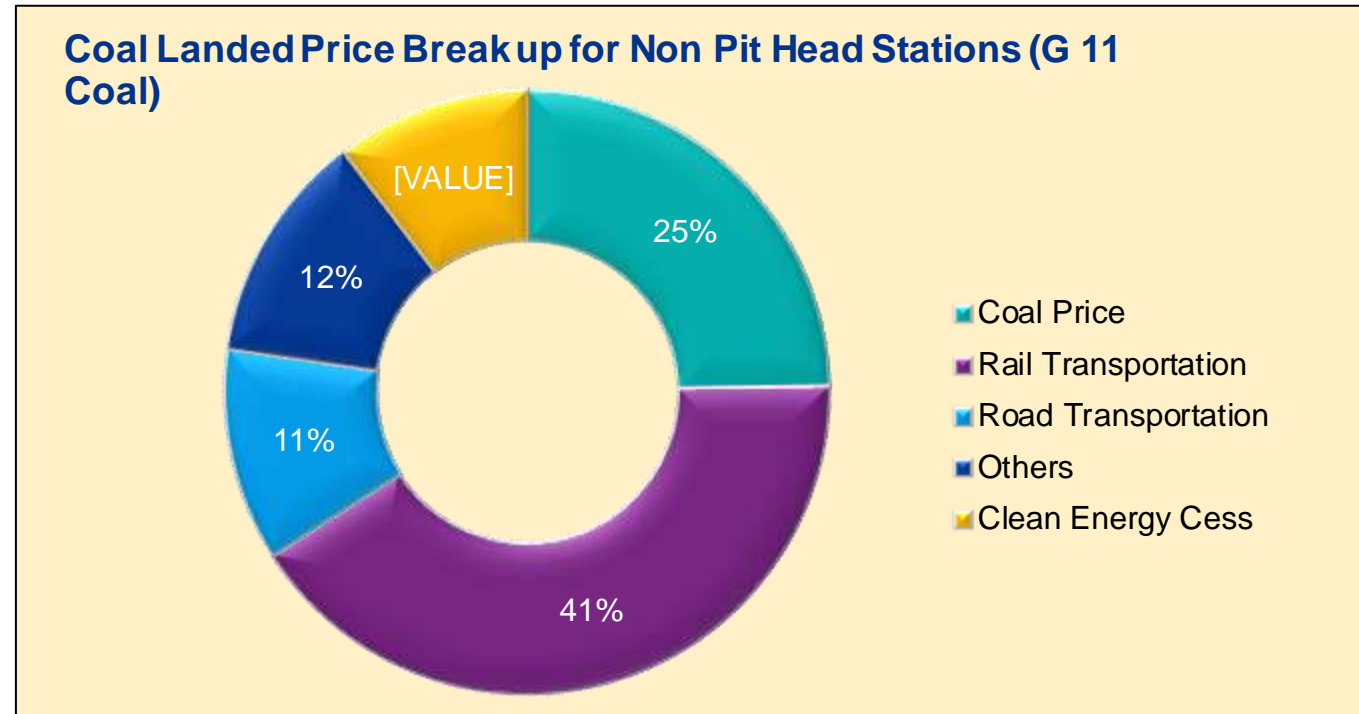

For non pit-head stations,

- Transportation Cost accounts for around **50% of total landed cost of coal**
- Clean energy cess contributes to around **10% of total landed cost of coal** which will be around 12-20% for landed cost of coal for pit head stations

Reduction in clean energy cess

Parameter	Value
Total Coal and Lignite Consumption for Power Generation in FY 2017-18 (as per MOSPI Report)	614.53 Million Tonnes
Total Annual Thermal Generation in FY 2017-18 (CEA Report)	1,037 Billion Units
Annual savings due to reduction in Clean Energy Cess by Rs 100/MT	Rs 6,145 Crore
Impact of Rs 100/MT reduction in Clean Energy Cess on per unit energy charge	Around 6 paise per unit (approximately 3%)
Impact of Rs 50/MT reduction in Clean Energy Cess on per unit energy charge	Around 3 paise per unit (approximately 1.5%)

*The above analysis is only indicative. A detailed analysis on this aspect will be conducted during the study.

Coal GCV loss: Maharashtra case study

Actual GCV for FY 2018-19 (MSPGCL)

Source	GCV (at Loading End - EB) in kcal/kg	GCV As Received (EB) in kcal/kg	Grade Slippage (kcal/kg)	GCV As Received (After Moisture Correction) in kcal/kg	Moisture Loss (kcal/kg)	Total GCV Loss (kcal/kg)	Quantum (MT)	Proportion (%)
	A	B	C=B-A	D	E=B-D	F=C+E		
WCL	3,954	3,575	379	3,270	305	684	2,58,69,068	74.0%
MCL	3,514	3,364	150	3,086	278	428	27,03,647	7.7%
SECL	3,921	3,688	233	3,343	345	578	16,39,826	4.7%
SECL	4,083	3,651	432	3,380	271	703	47,48,426	13.6%
MSPGCL-Wtd. Avg.	3,936	3,574	362	3,274	300	662	3,49,60,968	

- ❑ It can be observed from the data that the total GCV loss between as billed basis and as received basis is 662 Kcal/kg, which consists of 362 kcal/kg on account of Grade Slippage and 300 kcal/kg on account of Moisture loss.
- ❑ MERC Tariff Regulations 2019 specifies that the GCV loss between GCV as billed and GCV as received would be allowed at actuals subject to maximum of 300 kcal/kg.

Coal GCV loss: Maharashtra case study

Actual GCV for FY 2019-20 (April to Oct 2019.)

Source	GCV (at Loading End -EB) in kcal/kg	GCV As Received (EB) in kcal/kg	Grade Slippage (kcal/kg)	GCV As Received (After Moisture Correction) in kcal/kg	Moisture Loss (kcal/kg)	Total GCV Loss (kcal/kg)	Quantum (MT)	Proportion (%)
	A	B	C=B-A	D	E=B-D	F=C+E		
WCL	4,115	3,491	624	3,168	323	947	12,993,932	72.0%
MCL	3,537	3,565	(28)	3,225	340	312	1,390,724	7.7%
SECL	3,814	3,752	62	3,404	348	410	732,058	4.1%
SCCL	3,430	3,149	281	2,900	249	530	2,938,306	16.3%
MSPGCL-Wtd. Avg.	3,947	3,452	495	3,138	313	808	18,055,020	

- ❑ GCV loss between As Billed and As Received is 808 kcal/kg for MSPGCL as a whole, comprising 495 kcal/kg towards Grade Slippage and 313 kcal/kg towards moisture correction.
- ❑ The GCV loss for FY 2019-20 (April to October) is higher than FY 2018-19, because losses are higher during the monsoon season.

Coal GCV loss: Maharashtra case study

Observations of MERC on GCV of Coal

GCV loss between as billed and as received for FY 2018-19

662
kcal/kg¹

GCV loss between as billed and as received for FY 2019-20

792
kcal/kg²

❑ The Commission observed that if entire GCV loss is allowed, then there will be no incentive for MSPGCL to control the GCV loss.

❑ Hence in addition to the relaxation of 300 kcal/kg, the Commission decided to provide extra relaxation on account of GCV for the subsequent years, provided in the table below:

Particulars	GCV Relaxation as per Regulations	Additional GCV relaxation	Total Relaxation in GCV
	kcal/kg	kcal/kg	kcal/kg
FY 2020-21	300	225	525
FY 2021-22	300	200	500
FY 2022-23	300	175	475
FY 2023-24	300	150	450
FY 2024-25	300	125	425

¹ 362 kcal/kg - Grade Slippage and 300 kcal/kg-Moisture correction ² 492 kcal/kg –Grade slippage and 300 kcal/kg-Moisture correction

Impact of GCV loss on energy charge

Sample Impact of GCV Loss on Energy Charges

Sample Impact of GCV	Unit	GCV-3408	GCV-3308	GCV-3208
Installed Capacity	MW	210	210	210
Plant Load Factor (%)	%	85.00%	85.00%	85.00%
Gross Generation	MU	1563.7	1563.7	1563.7
Auxiliary Consumption	%	11.0%	11.0%	11.0%
Net Generation	MU	1392.3	1392.3	1392.3
Station Heat Rate	kCal/kWh	2450	2450	2450
Secondary Fuel Oil Consumption	ml/kWh	2	2	2
GCV of Oil	kCal/litre	10589	10589	10589
GCV of Coal	kCal/kg	3,408.0	3,308.0	3,208.0
Price of coal	Rs./MT	3410	3410	3410
Energy Charge Rate (Ex-bus)	Rs./kWh	2.79	2.88	2.97
Reduction in Energy Charges (in %)			3%	3%

❑ Every 100 kcal/kg GCV loss impacts the Energy Charges by 3%

Summary: Cost and quality of coal, grade slippages, railway freight

Hypothesis: Cost of coal for TPPs has increased disproportionately as compared to other cost components

- ❑ Fixed charges contribute around **25-40%** whereas energy charges contribute around **60-70% to the overall PPC**
- ❑ Coal price accounts for around **25% of landed cost of fuel**
 - Coal prices (in last 4 yrs.) were about **28%¹** higher as compared to the price based on WPI and wt. avg. of WPI and CPI.
- ❑ Rail freight accounts for **~40% of landed cost of fuel**
 - Railway freight (in last 4 yrs.) was about **~30%²** higher as compared to freight based on WPI and wt. avg. of WPI and CPI.
- ❑ Clean energy cess has increased from Rs. 50/Tonne in 2010 to Rs. 400/Tonne in 2016.
 - Reduction of clean energy cess by Rs 50/MT may reduce the ACoS by around **3 paise per unit**
- ❑ Every 100 kcal/kg loss in GCV results in **~3% increase** in energy charges

¹ Actual coal prices compared to coal prices based on WPI and wt. avg. of WPI & CPI during Jan' 2018

² Actual railway freight compared to freight based on WPI and wt. avg. of WPI & CPI during Nov' 2018

Transmission charges



Transmission

Comparison of actual energy requirement and peak demand starting FY 2016-17 vis-à-vis planned (as per 19th EPS)

Actual and projected energy requirement (in BUs) starting FY 2016-17 at an all India-level

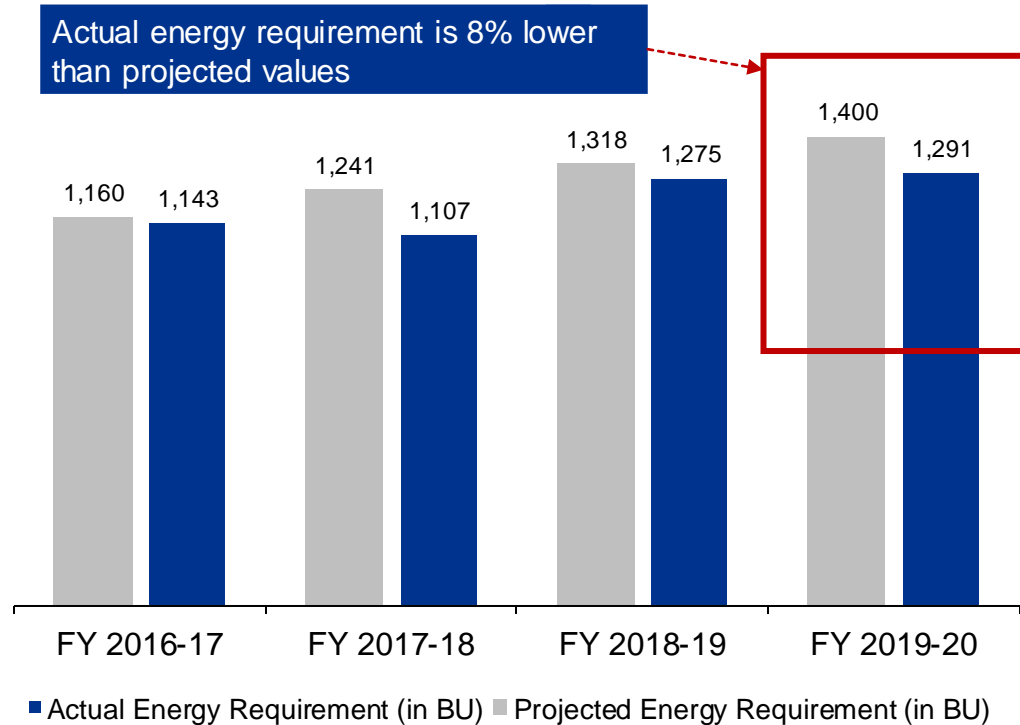

Actual and projected peak demand (in MWs) starting FY 2016-17

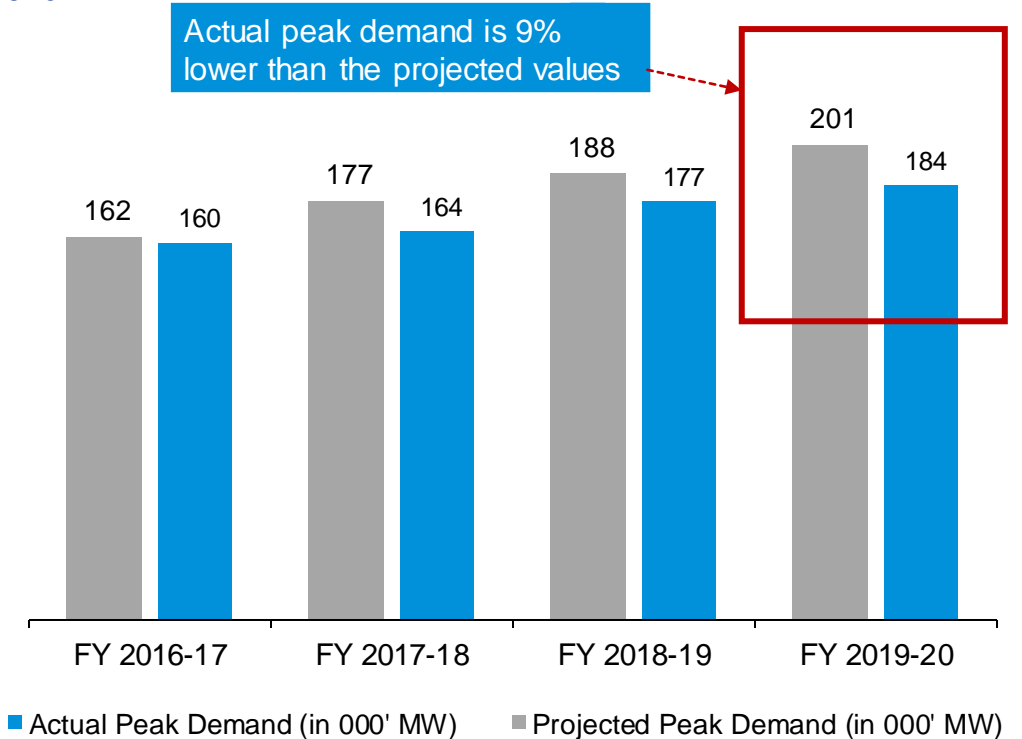

- Energy and peak demand in the country was about 2-12% less than projected (as per the 19th EPS)
- Transmission assets were developed based on projections

Transmission capacity

Historical trend of transmission capacity

Cumulative transmission assets (inter-state and intra-state)

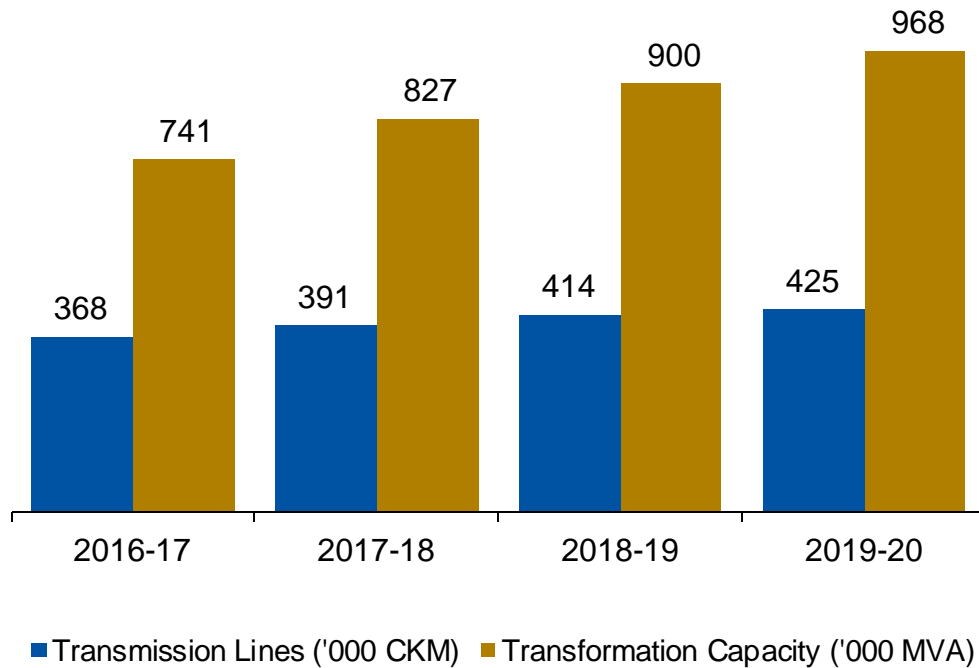

Inter-state transmission capacity addition vis-à-vis planned

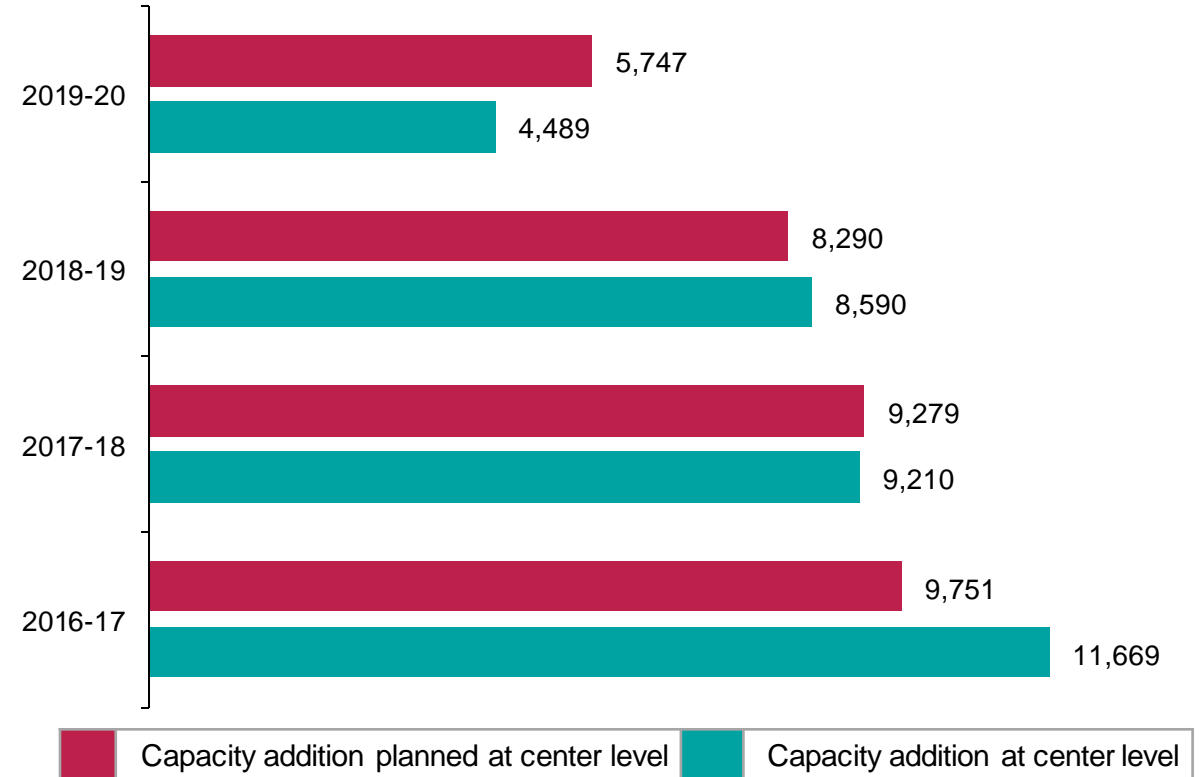

Transmission capacity has increased as planned with 5% CAGR Growth (CKM) in lines and 9% CAGR Growth in transformation capacity

Transmission charges

Voltage wise capacity addition vis-à-vis planned

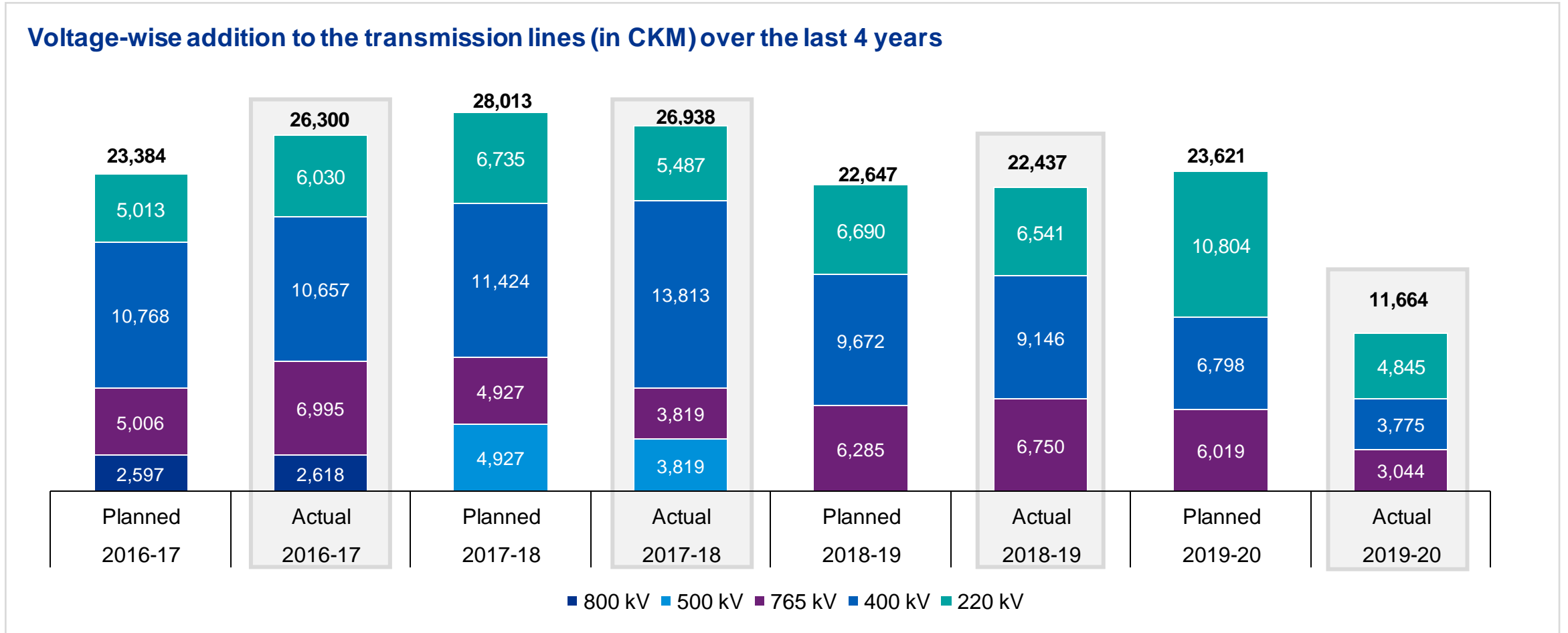

Capacity addition of 400 kV transmission lines accounted for 43% of the cumulative addition over the last 4 years

Power procurement from central generating stations

Actual power purchased from CGS vis-à-vis approved

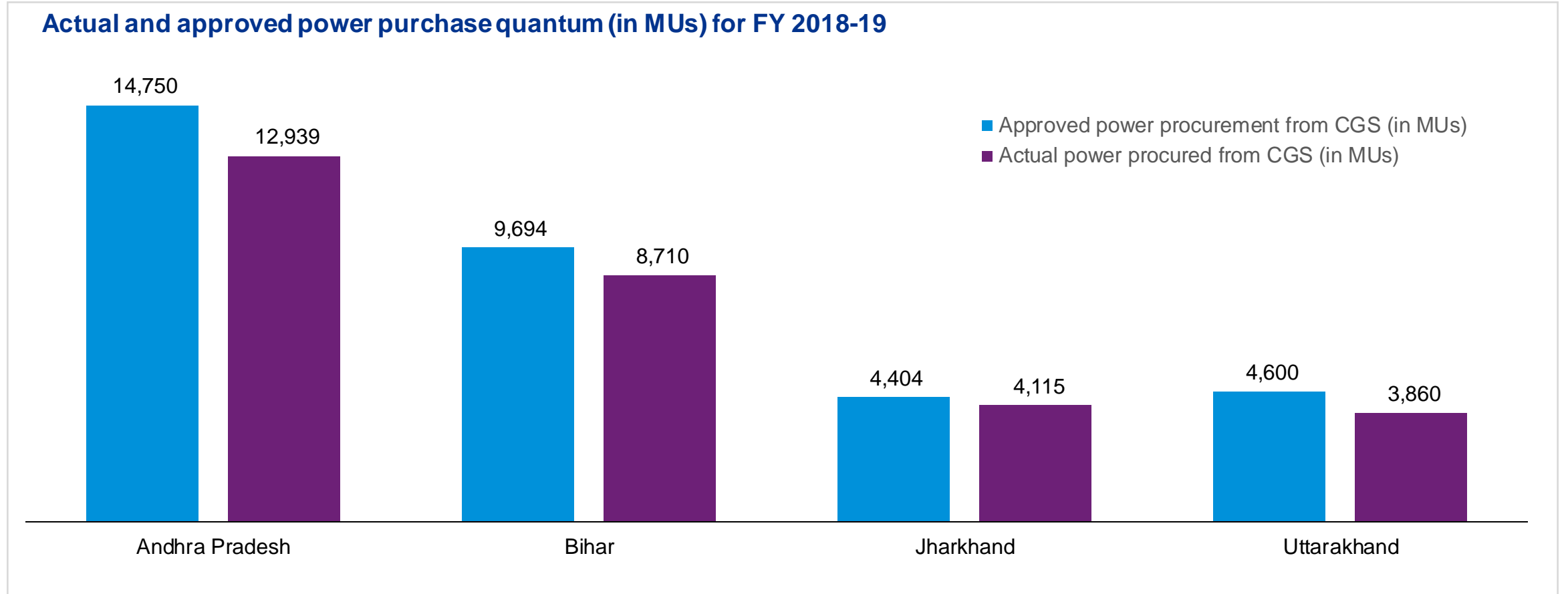

• Uttarakhand, Andhra Pradesh, Bihar and Jharkhand procured about ~84%-93% of the booked capacity from central sector plants for FY 2018-19

Annual transmission charges

Annual transmission charges (Rs. 000' Crore)¹

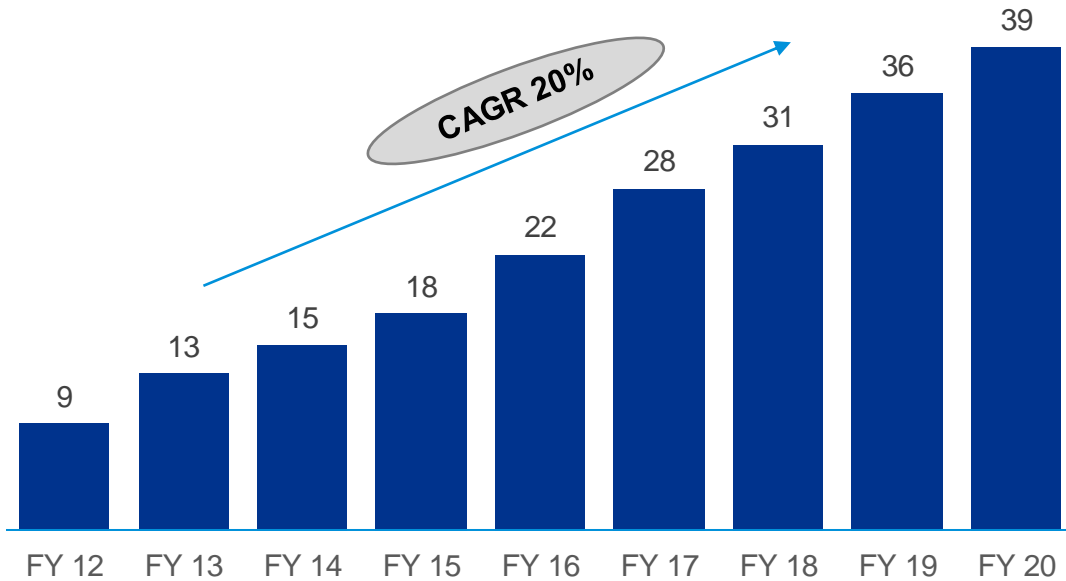

Annual transmission charges (Rs. 000's Cr) have increased at a CAGR 20% over the last 9 years

Transmission charges per unit of power generated from CGS (Rs./unit)²

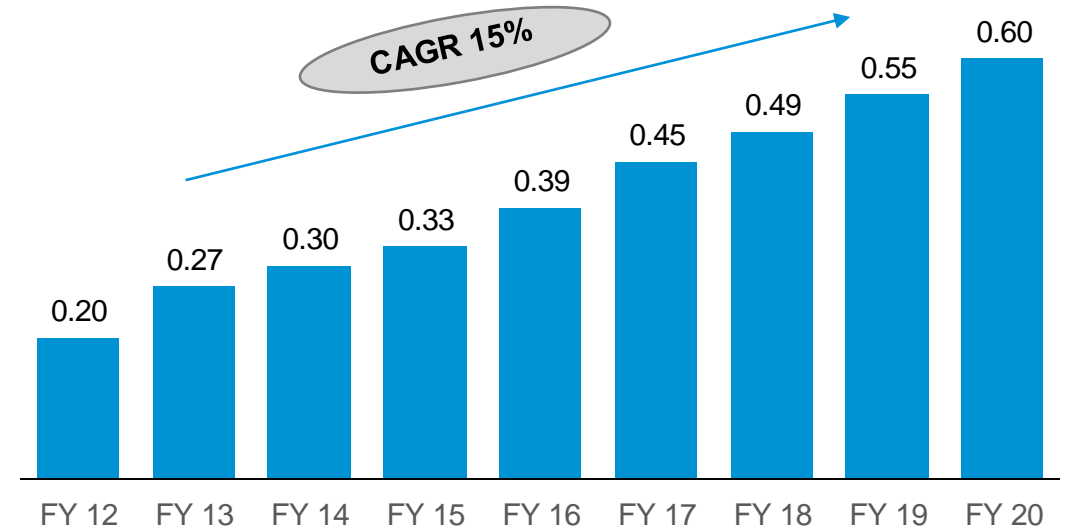

Transmission charges per unit power generated from CGS have increased at a CAGR of 15% over the last 9 years

Annual transmission charges and power procured from ISGS

¹ Source: CEA monthly generation report, CERC short term market monitoring report for FY 2019-20

² Power generated from CGS has been estimated by adding total generation from central sector plants and 50% of total generation from private sector plants

Transmission charges

Hypothesis: Regulated transmission tariff is higher than that discovered through competitive bidding

- ❑ Levelized cost discovered through competitive bidding for RECTPCL projects

Scheme Name	Tariff discovered through Competitive Bidding			Levelized Cost as per CERC (Rs. Crore)	Difference in levelized costs (in %)
	Project Cost (Rs. Crore)	Line Length (in km)	Levelized Cost of L1 Bidder (Rs. Crore)		
Transmission System (TS) Gadarwara STPS (2 x 800 MW) of NTPC (Part-B)	3,683	489	257	527	51%
TS Gadarwara STPS (2 x 800 MW) of NTPC (Part-A)	4,071	538	290	593	51%
TS Strengthening Vindhyachal-V	2,845	383	211	421	50%
Khargone TPP 1320MW	2,137	466	159	310	49%
Construction of Ajmer (PG)-Phagi 765 kV D/C line	872	132	61	118	48%
Construction of 765/400/220kV GIS Substation, Rampur and 400/220/132kV GIS Substation, Sambhal with Transmission Lines	1,094	72	103	187	45%

Tariffs being discovered through competitive bidding are significantly lower than the tariffs approved by the central regulator

Summary: Transmission charges

Hypothesis: Interstate transmission charges have increased over the last 4 years and during this period pan India market has also improved, enhancing reliability of grid operations (intangible benefits for all stakeholders)

- **Transmission infrastructure was developed based on demand projections**
- Inter-state transmission capacity was booked by state utilities based on anticipated demand
- Reduction in procurement from central sector plants as compared with capacity allocated has led to reduced utilization of inter-state transmission assets (short-term)
- ATC per unit power procured from central sector stations have increased significantly over the last 9 years
- Further, **tariff discovered through competitive bidding is significantly lower than regulated tariff**. SERCs may consider following competitive bidding route to reduce transmission costs and ACoS.
- As per the Tariff policy 2016, *“intra-state transmission projects shall be developed by State Government through competitive bidding process for projects costing above a threshold limit which shall be decided by the SERCs”*
- The state of Rajasthan has implemented competitive bidding process for transmission projects through RVPNL

Fixed Cost Elements



Return on Equity



ROE for generation, transmission and distribution companies

Hypothesis: Change in norms for estimation of ROE, may lead to significant reduction in electricity tariffs

Rate of RoE approved through various control periods by CERC

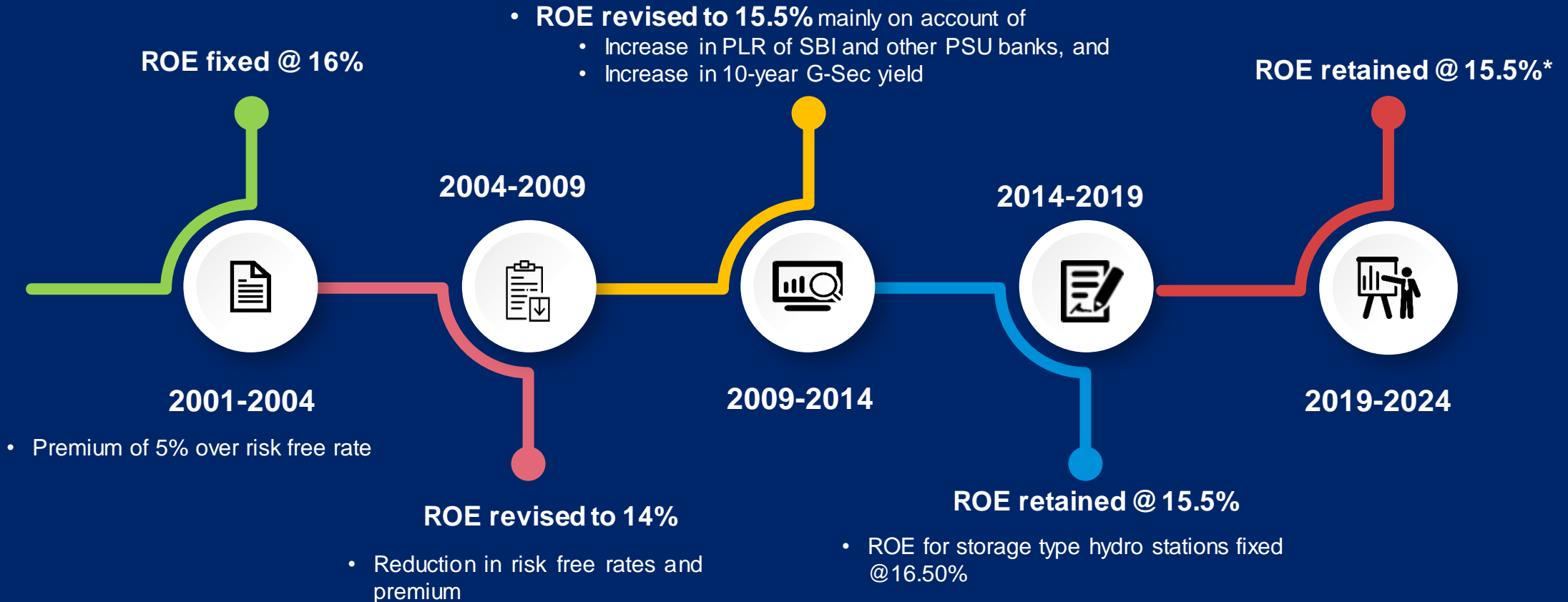

*Reduction in RoE by 1% given the station is declared under COD without commissioning of any of the RGMO or FGMO, data telemetry, communication system up to load dispatch center or protection system based on the report submitted by the respective RLDC.

ROE for generation, transmission and distribution companies

□ Rate of Return on equity in different states as per tariff regulations across the value chain

S. No.	States	State GENCO	TRANSCOs	DISCOMs
1	Odisha	16.0%	15.5%	16.0%
2	Maharashtra	15.5%	15.5%	15.5%
3	Uttar Pradesh	15.5%	14.5%	16.0%
4	MP	15.5%	15.5%	16.0%
5	Chhattisgarh	15.5%	15.5%	16.0%
6	Assam	15.5%	15.5%	16.0%
7	Himachal Pradesh	15.5%	15.5%	16.0%
8	West Bengal	15.5%	15.5%	15.5%
9	Uttarakhand	15.5%	15.5%	15.5%
10	Tripura	15.5% - 16.5%*	15.5%	15.5%
11	Punjab	15.5% - 16.5%*	15.5%	15.5%
12	Nagaland	15.5%	15.5%	15.5%
13	Manipur	15.5%	15.5%	15.5%
14	Mizoram	15.5%	15.5%	15.5%

S. No.	States	State GENCO	TRANSCO	DISCOM
15	Karnataka	15.5%	15.5%	15.5%
16	Jharkhand	14.0%	14.0%	14.5%
17	Jammu & Kashmir	15.5%	15.5%	15.5%
18	Bihar	15.5%	15.5%	15.5%
19	Andhra Pradesh	15.5%	14.0%	14.0%
20	Telangana	15.5%	14.0%	14.0%
21	Arunachal Pradesh	15.0%	14.0%	16.0%
22	Rajasthan	15.0%	14.0%	16.0%
23	Tamil Nadu	14.0%	14.0%	14.0%
24	Gujarat	14.0%	14.0%	14.0%
25	Haryana	14.0%	14.0%	14.0%
26	Kerala	14.0%	14.0%	14.0%
27	Delhi	14.0%	14.0%	16.0%
28	Sikkim	14.0%	14.0%	14.0%
29	Meghalaya	14.0%	14.0%	14.0%

Rate of ROE >15.50%	Rate of ROE equal to 15.50%	Rate of ROE <15.50%
---------------------	-----------------------------	---------------------

Several states have post-tax rate of return on equity lower than 15.50% as per tariff regulations

*For the state of Punjab and Tripura, it is mentioned in the tariff regulations that return on equity shall be computed at the rate of 15.50% and 16.50% for thermal power stations and storage type hydro generating stations, respectively.

*Source: Respective generation, transmission and distribution tariff regulations

Government securities (G-Sec) yield and prime lending rates

It can be observed that the primary lending rate and the G-Sec Rates have shown a declining trend over the years.

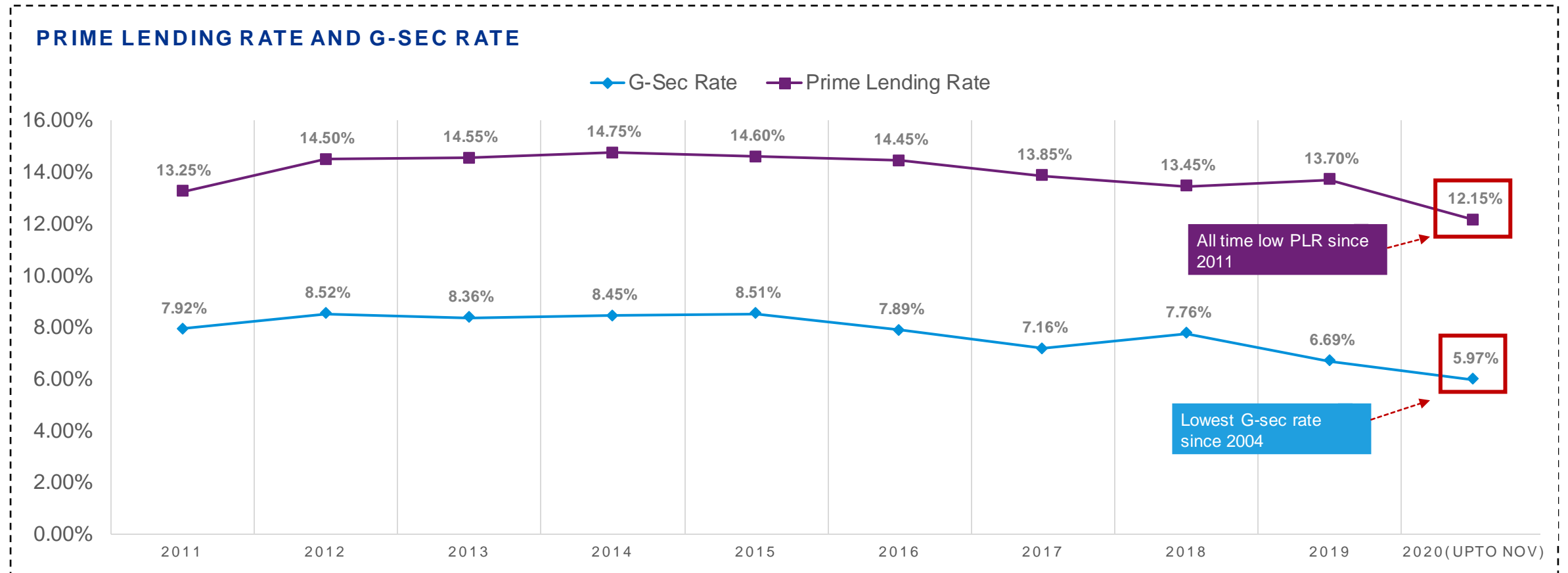

The rate of return on equity might be reviewed considering the present market expectations and risk perception of power sector for new projects

Source: Source: SBI Website (PLR); CERC Explanatory Memorandum 2019 (G-Sec Rates)

Approved ROE for 12 states in FY 2020-21

Contribution of ROE to the overall ARR

(All Figures in Rs. Cr. except wherever mentioned)

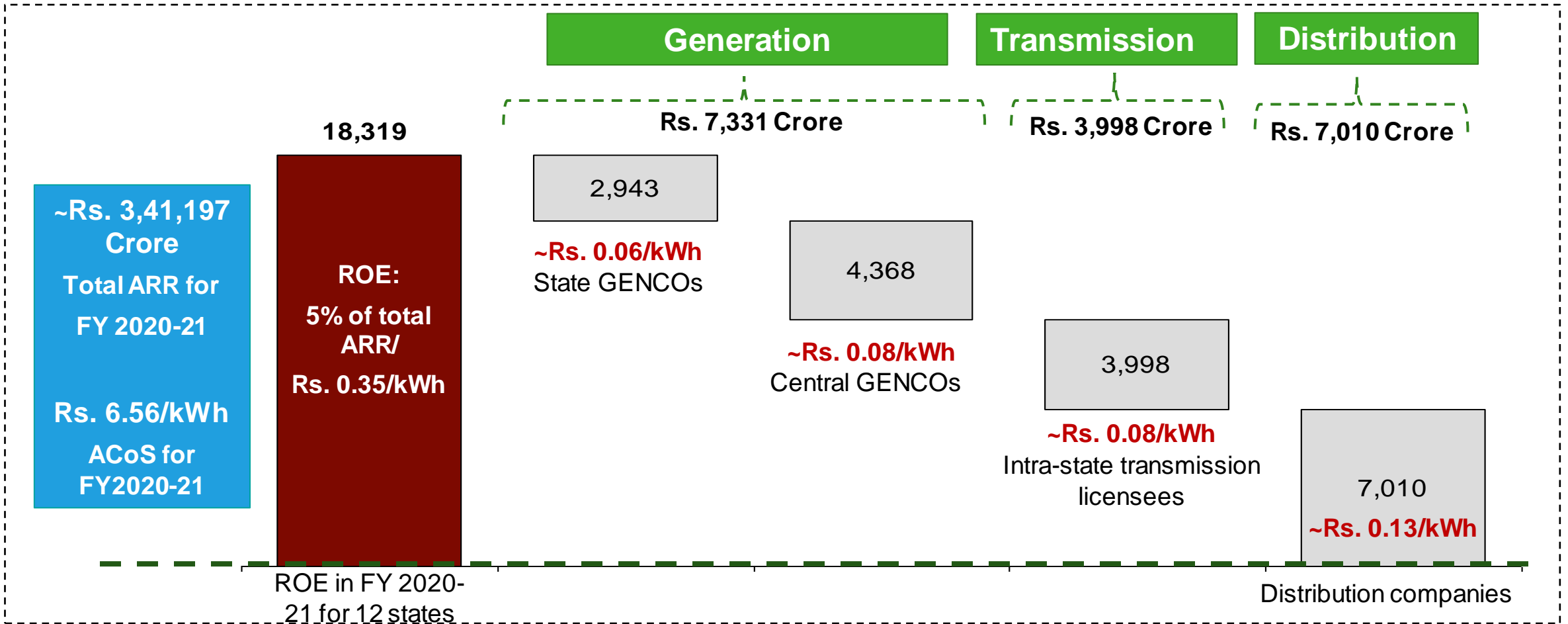

• RoE is computed for sample thermal power plants, data for some thermal power plants and Power Purchase breakup for states like AP & Odisha are not available in public domain; The above analysis does not include approved ROE for inter-state transmission licensee

State-wise approved ROE for GENCO, TRANSCOs and DISCOMs for FY 2019-20

*Source: Generation, transmission and distribution tariff orders issued for 12 states by respective commissions

Change in the rate of ROE

❑ For the tariff period 2019-24, the Commission has approved post tax base rate of 15.5%

Reduction in ACoS (in Rs./kWh) for 12 states at 14% and 12% rate of ROE during FY 2020-21

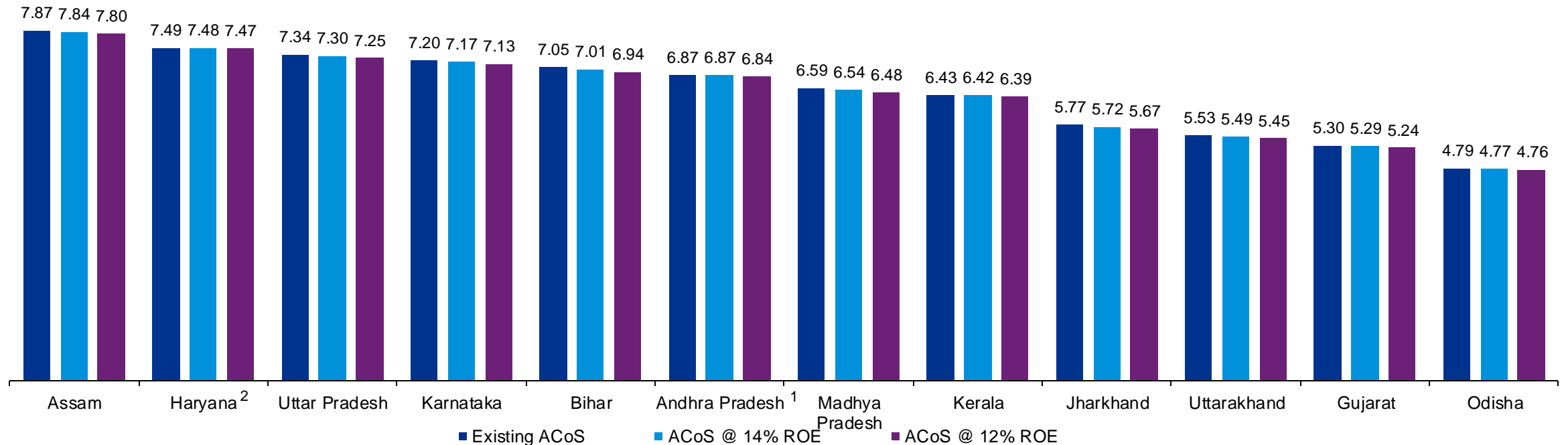

- Reduction of approved rate of ROE to **12%** would reduce ACoS by **~Rs. 3,474 Crore/Rs. 0.07/kWh (1.0%)**
- Reduction of approved rate of ROE to **14%** would reduce ACoS by **~ Rs. 1,230 Crore/ Rs. 0.02/kWh (0.4%)**

Reduction in ACoS is computed at 14%/12% rate of return or on actual rate whichever is lower; Reduction in ACoS has been rounded off to two decimal places

¹For the state of Andhra Pradesh, the commission has approved 14% ROE for generation, transmission and distribution companies for 2020-21

²For the state of Haryana, the Commission has not allowed ROE for DISCOMs for 2020-21 due to the unprecedented situation emanating from the COVID-19 pandemic and the resulting restriction/lockdown ordered by Central Government/State Government

Tariff discovered through competitive bidding

S. No.	Company	Year	Lowest quoted tariff(Rs/kWh)	State	Tariff approved by state electricity regulatory commission(Rs/kWh)
1	SECI, 1070 MW Solar Auction	2020-21	2.00 ¹	Rajasthan	2.5 ² (for FY 2020)
2	GUVNL, Raghnesda Park 100 MW, Gujarat	2019-20	2.65 ³	Gujarat	5.34 ⁴ (for FY 2018)
3	SECI, Kadapa Solar Park (AP)	2018-19	2.70 ⁵	Andhra Pradesh	3.5 ⁶ (for FY 2019)
4	NTPC, Ananthapuram Solar Park 750 MW(AP)	2018-19	2.72 ⁷	Andhra Pradesh	3.5 ⁶ (for FY 2019)

Tariffs being discovered through competitive bidding are significantly lower than the tariffs approved by the central regulator

Source:

¹ <https://mercomindia.com/new-solar-tariff-record/>

³ <https://mercomindia.com/gujarat-tariff-2-65-solar-park/>

⁵ <https://mercomindia.com/solar-projects-andhra-pradesh-delays/>

⁷ <https://mercomindia.com/nptc-750mw-solar-auction-results/>

² <https://rerc.rajasthan.gov.in/rerc-user-files/tariff-orders>

⁴ https://www.gercin.org/wp-content/uploads/2020/05/GERC-Solar-Tariff-Order-No.03-2020_08052020.pdf

⁶ <http://aperc.gov.in/admin/upload/PettiionOP67of2019.pdf>

Depreciation cost



Depreciation cost

Hypothesis: Change in norms for estimation of depreciation, may lead to significant reduction in electricity tariffs

- ❑ The depreciation reserve is created to fully meet the debt service obligation and is a major component of the annual fixed cost across the value chain.

Regulatory Framework	<ul style="list-style-type: none">• Straight Line Method (SLM) of depreciation has been used in all the previous four tariff periods.• Useful lives of all types of generating stations and transmission systems except gas-based generating stations have remained same in all the tariff periods.
Other Provisions	<ul style="list-style-type: none">• In 2001 and 2004 Tariff Regulations, the Commission had adopted the provision of Advance Against Depreciation (AAD) in order to ensure enough cash flows to meet loan repayment obligations• However, the 2009 Tariff Regulations dispensed with the provision of AAD.• The depreciation rate was worked out by considering normative repayment period of 12 years to repay the long-term loan (70% of the capital cost).

Approved depreciation cost for 12 states in FY 2020-21

Contribution of depreciation cost to the overall ARR

(All Figures in Rs. Cr. except wherever mentioned)

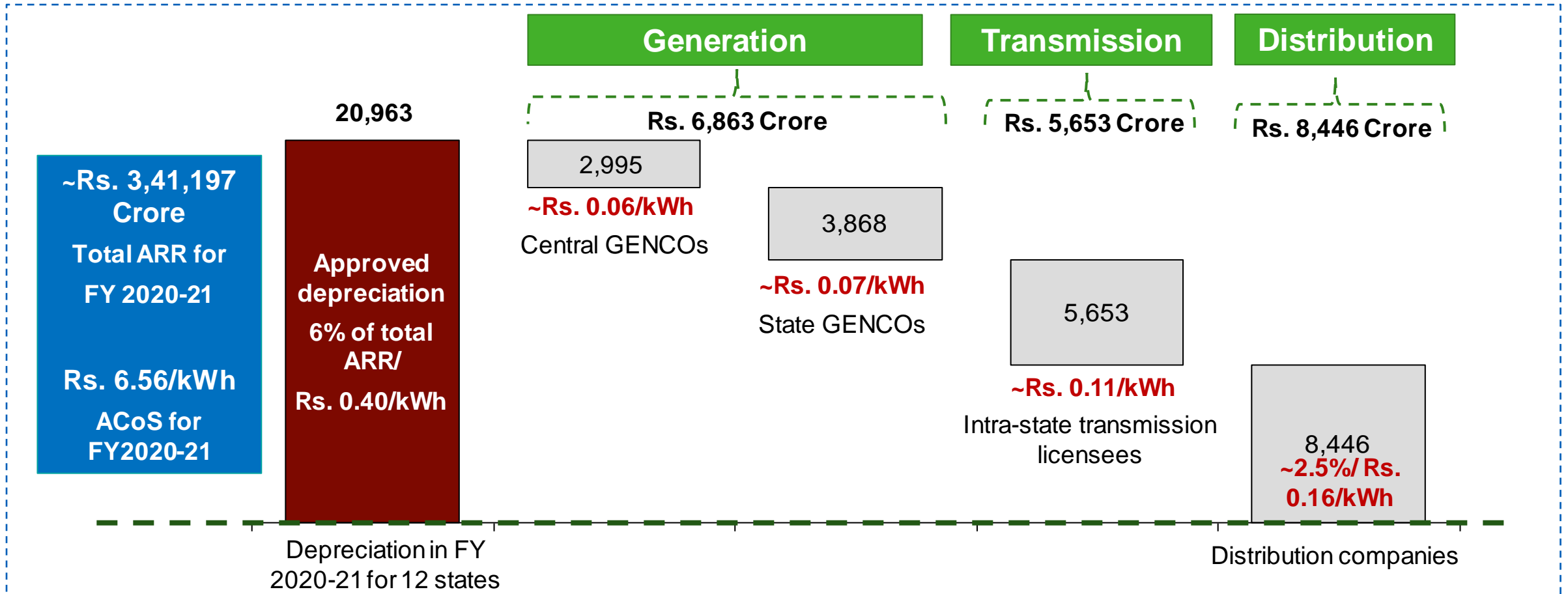

- Depreciation is computed for sample thermal power plants, data for some thermal power plants and Power Purchase breakup for states of AP & Odisha are not available in public domain. The above analysis does not include approved depreciation costs for inter-state transmission licensee

State-wise approved depreciation for GENCO, TRANSCOs and DISCOMs for FY 2019-20

*Source: Generation, transmission and distribution tariff orders issued for 12 states by respective commissions

Change in the rate of depreciation

- ❑ As per the prevailing norms, depreciation rate is estimated by considering loan repayment period of 12 years to repay the loan (70% of the capital cost)
- ❑ Reduction of depreciation rate to 4.67% (considering loan repayment period of 15 years to repay 70% of the capital cost) would reduce ACoS by **~Rs. 3,500-4,000 Crore/ Rs. 0.08kWh (1.2%)**
- ❑ Reduction of depreciation rate to 4.34% (considering loan repayment period of 15 years to repay 65% of the capital cost) would reduce ACoS by **~Rs. 4,500-4,800 Crore/ Rs. 0.10kWh (1.4%)**

Depreciation norms: Petroleum sector

Petroleum and Natural Gas Regulatory Board (PGRB)

- Determines the transportation tariff for (a) Petroleum and Petroleum Products pipelines and (b) Natural Gas pipelines (awarded on nomination basis)

Tariff determination for transportation of →	Petroleum and Petroleum Products	Natural Gas
Regulation	Determination of Petroleum and Petroleum Products Pipeline Transportation Tariff) Regulations, 2010	Determination of Natural Gas Pipeline Tariff Regulations, 2008
Procedure for Tariff determination	Benchmarking against rail tariff at a level of 75% (100% for LPG) on a train load basis for equivalent rail distance along the petroleum and petroleum product pipeline route.	Cost plus basis
Treatment of Depreciation	Not Applicable	<ul style="list-style-type: none"> ▪ Rate of Depreciation: Depreciation on fixed assets on straight line basis based on rates as per Schedule VI to the Companies Act, 1956)
Regulation	Determination of Petroleum and Petroleum Products Pipeline Transportation Tariff) Regulations, 2010	Determination of Natural Gas Pipeline Tariff Regulations, 2008

Depreciation rationalization – Case study of Uttar Pradesh

Uttar Pradesh Electricity Regulatory Commission

- UPERC in their Tariff orders for FY 2012-13 mentioned that **“Components of the ARR viz., depreciation, allowable interest on debt and return on equity are adversely affected by inadvertent misrepresentations of capital assets creation numbers.”**
- In the same tariff order UPERC further submitted that **“...the Commission is severely hindered in its task of undertaking prudence check of ARR components viz., depreciation, and allowable interest on debt and return on equity. On account of lack of details of fixed assets register, the Commission has assessed depreciation based on wt. avg. depreciation rates...”**
- In FY 2013-14, UPERC **withheld 20%** of the allowable depreciation and mentioned that same may be allowed upon submission of FAR.
- Further, 25% depreciation of FY 2014-15, 30% in FY 2015-16 & FY 2016-17 **was withheld due to non submission of FAR**
- During the True-up for FY 2014-15 the DISCOMs submitted the FAR up to FY 2014-15 on June 21st, 2017.
- The commission noted, that there was a delay in submission of FAR (submitted on August’16 instead of November’ 13 as directed by UPERC). Consequently, the UPERC withheld the 20% of the allowable depreciation for FY 2013-14.
- During True-up of FY 2014-15, FY 2015-16 and FY 2016-17 the commission has allowed the withheld 25% depreciation, as the DISCOMs has submitted the FAR at the time of true-up

Summary: Fixed Cost Elements

Hypothesis: Change in norms for estimation of ROE and depreciation, may lead to significant reduction in electricity tariffs

- ROE (for G, T & D utilities) accounted for **5% of the total ARR** in FY 2020-21 for 12 states.
 - Reduction of approved rate of ROE to 14% and 12% may reduce ACoS by Rs. **Rs. 0.02/kWh (0.4%) and 0.07/kWh (1.0%)** respectively
- Depreciation (for G, T & D utilities) accounted for **6% of the total ARR** in FY 2020-21 for 12 states.
 - Reduction of depreciation rate to 4.67% and 4.34% may reduce ACoS by **Rs. 0.08kWh (1.2%) and Rs. 0.10kWh (1.4%)** respectively
- UPERC withheld a share of allowable depreciation in the absence of Fixed Asset Registers at the time of issuance of tariff order for FY 2013-14, FY 2014-15, FY 2015-16 & FY 2016-17

Analysis of internal factors



Approved distribution losses

Hypothesis: Change in approved distribution losses may lead to significant reduction in electricity tariffs

Distribution loss*

Approved distribution loss (%) for licensees of 12 states for FY 2020-21 and impact on ACoS

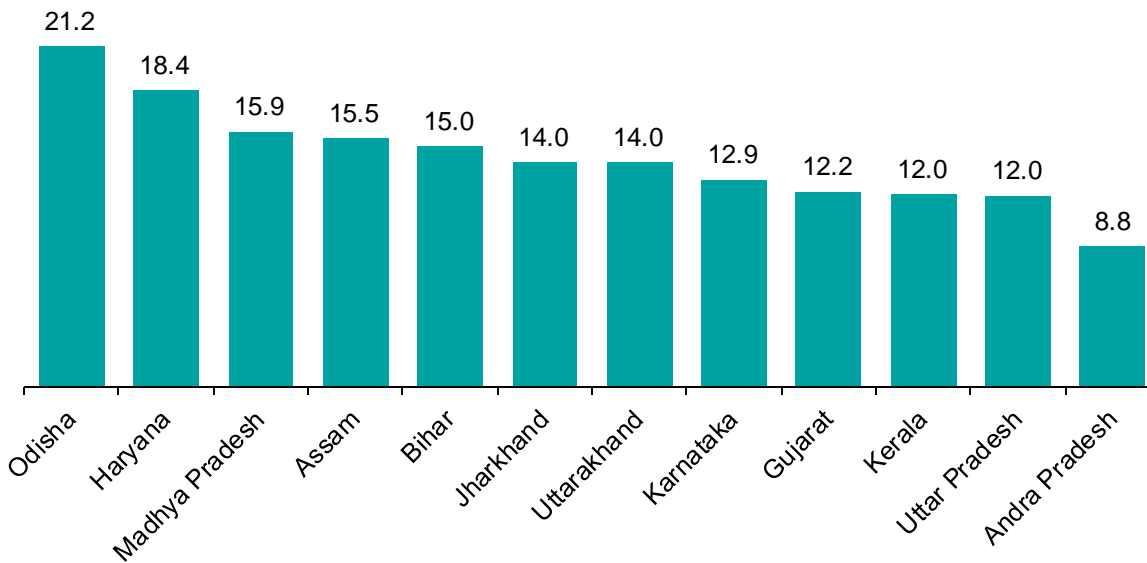

Reduction in ACoS (Rs/kWh) on account of change in rate of distribution loss

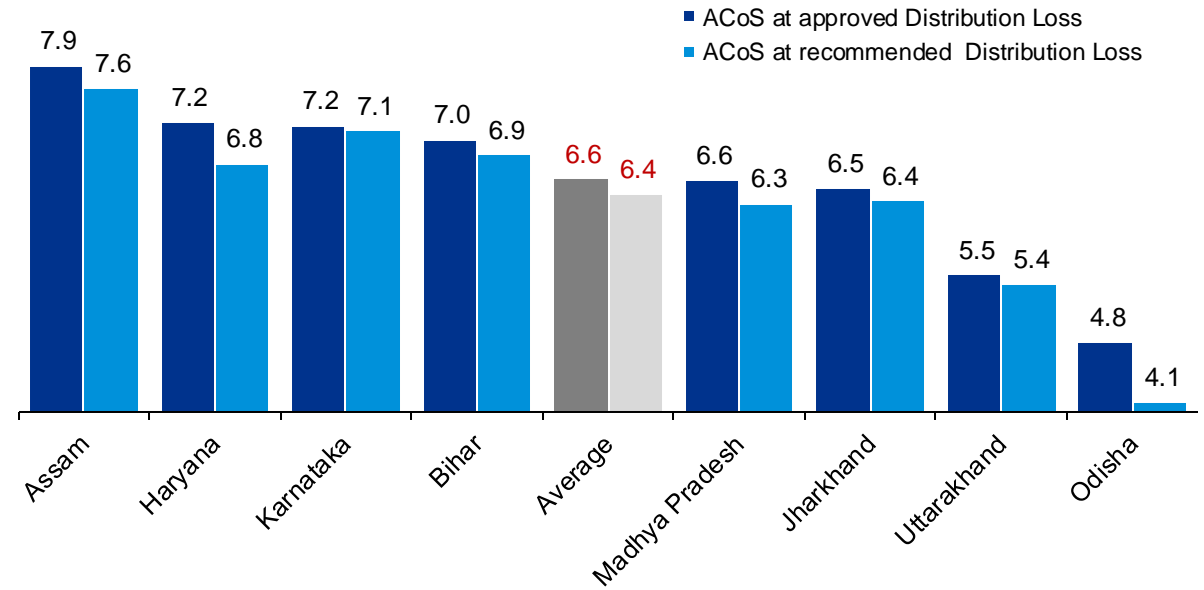

- The approved distribution losses for 12 states for FY 2020-21 varied in the range 12-18% (excluding Andhra Pradesh- ~9% and Odisha- ~21%)

- Reduction of approved rate of Distribution losses to 12% would reduce ACoS by **Rs. 0-0.66 /kWh/ (3%)**

*Distribution loss does not include inter-state and intra-state transmission losses

Approved Distribution Loss rates for DISCOMs

Hypothesis: Change in approved distribution losses may lead to significant reduction in electricity tariffs

Distribution Loss

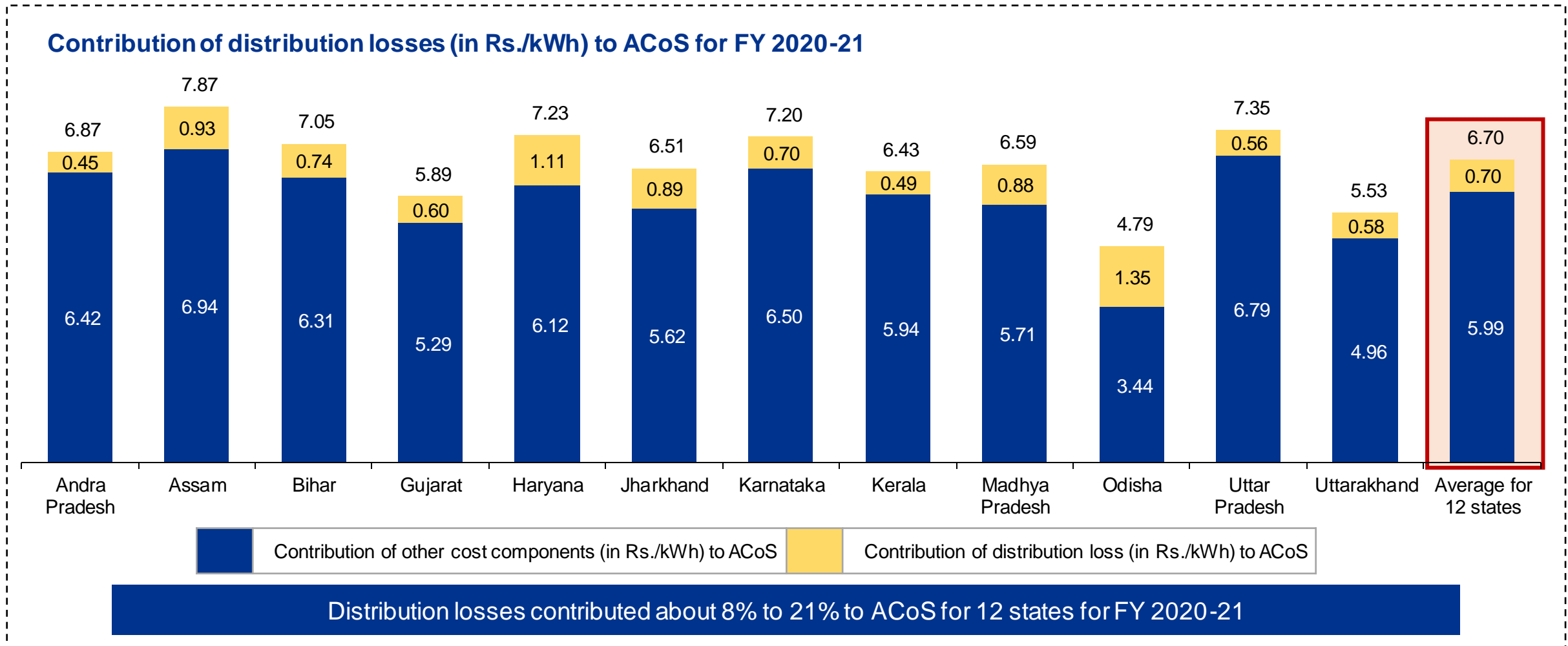

*Source: Distribution tariff orders issued for 12 states by respective commissions

O&M Expenses for DISCOMs

O&M Charges

Approved O&M Expense for licensees of 12 states for FY 2020-21*

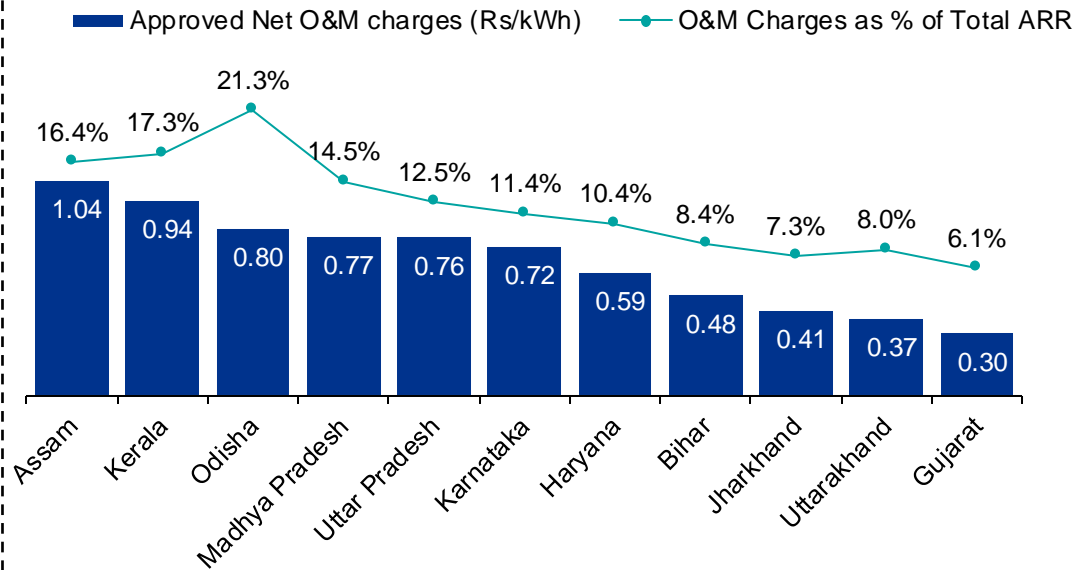

Expenditure on O&M (Rs) per 1000 units of energy handled by DISCOMs#

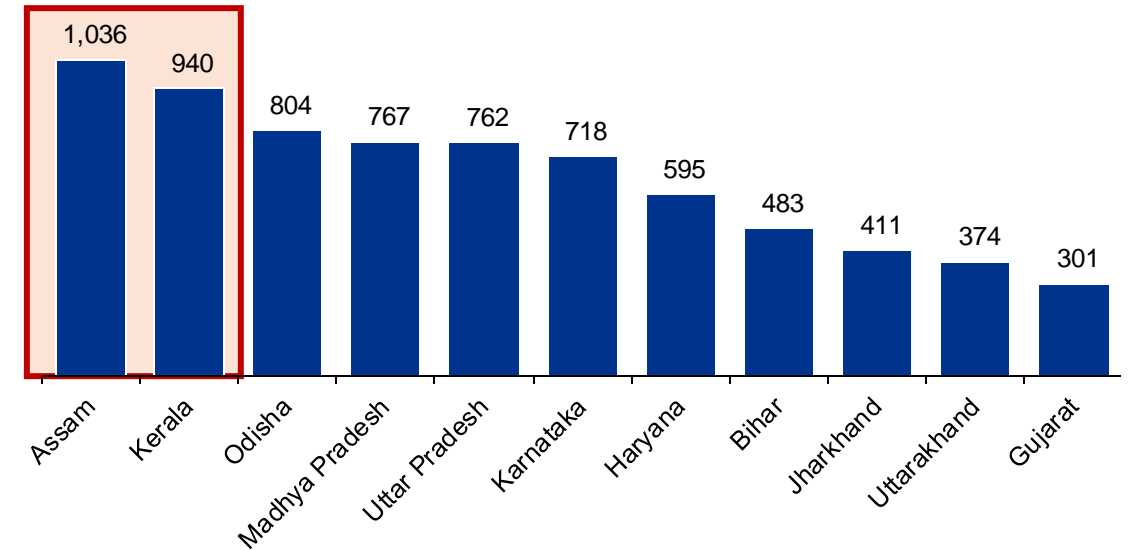

- Norms for approval of O&M expenses are based on historical cost performance of individual metrics such as total expense on lines per unit of line length created.

- Initiatives and field level best practices undertaken by better performing states (Gujarat, Uttarakhand, etc.) might be disseminated across states for reduction in O&M costs

#Expenditure on O&M shows a wide range of variation from Rs. 301 (Gujarat) to Rs 1,036 (Assam) per 1000 units of energy handled. This is mainly on account of variation in factors such as Number of Consumers, Network length and expanse, HT/LT ratio and age of infrastructure .

*Latest available TO is used for states wherein FY21 TO is not available

*Source: Distribution tariff orders issued for 12 states by respective commissions

O&M Expenses for state and central GENCOs

O&M Charges

Approved O&M Expense for generation licensees of 12 states for FY 2018-19*

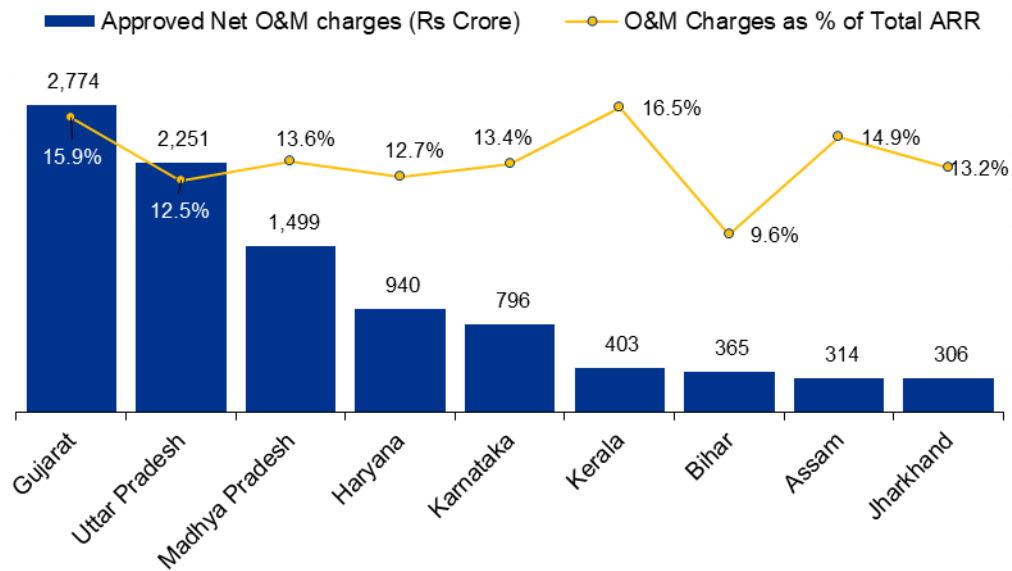

- Approved O&M expenses varied in the range of 10-16% of the total ARR of central and state GENCOs for the 12 states

Expenditure on O&M (Rs) per 1000 units of energy handled by DISCOMs

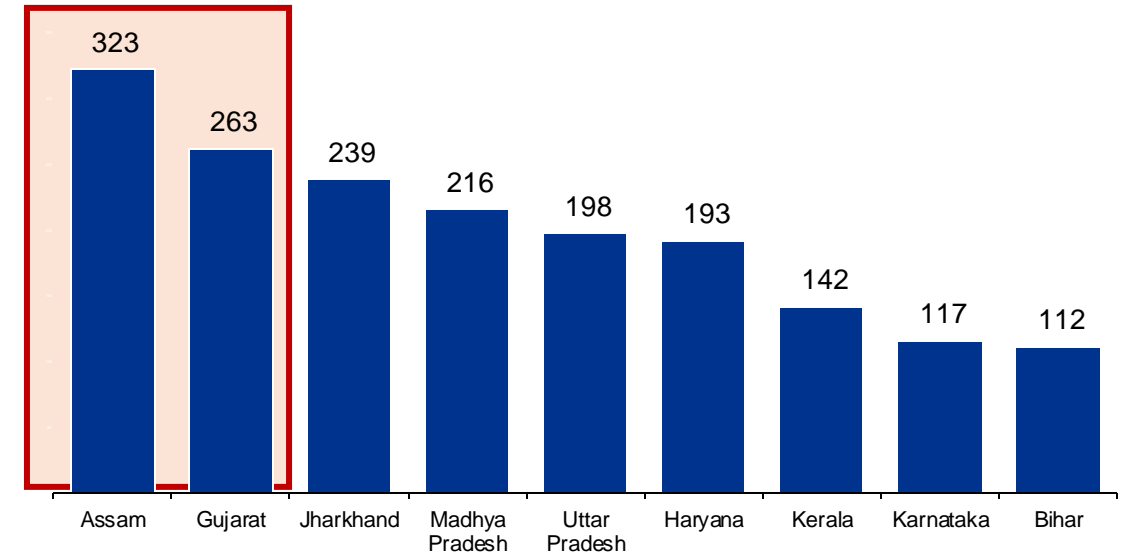

- Initiatives and field level best practices undertaken by better performing states (Karnataka, Bihar, etc.) might be disseminated across states for reduction in O&M costs

Source: Generation tariff orders issued for 12 states by respective commissions

*Latest available TO is used for state and central GENCOs

Interest & finance charges for DISCOMs

Interest charges

Approved I&F charges for licensees of 12 states for FY 2020-21*

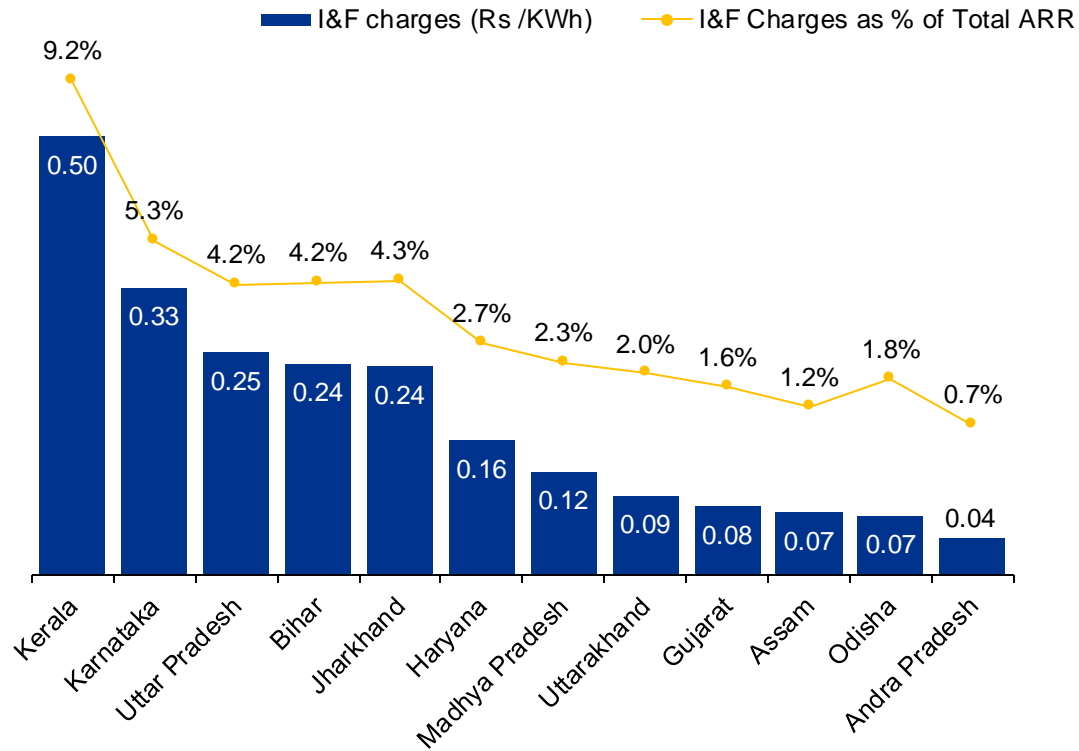

Expenditure on I&F per 1000 units of energy handled by DISCOMs

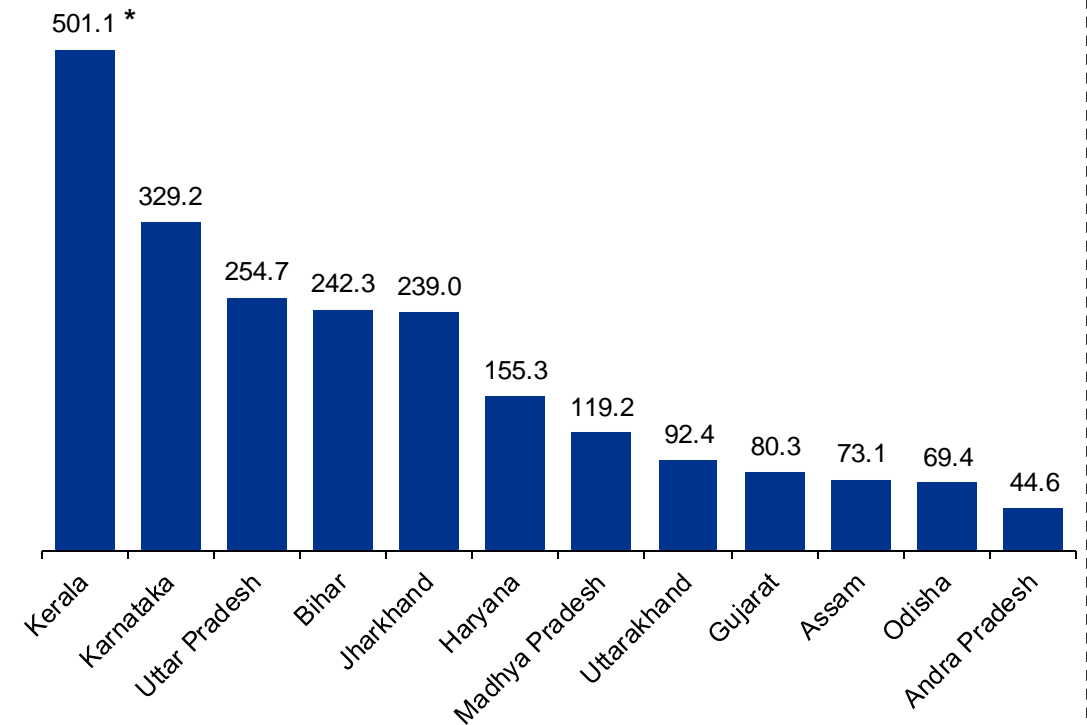

*Interest expense of KSEB includes expenses for Generation, Transmission and Distribution entities

*Source: Distribution tariff orders issued for 12 states by respective commissions

Summary: Internal Factors

Hypothesis: Change in norms for internal factors may lead to significant reduction in electricity tariffs

- ❑ Approved distribution losses accounted for ~**8%-21% of ACoS** for 12 states for FY 2020-21
 - Reduction of approved Distribution losses to 12% would reduce ACoS by **Rs. 0.00-0.66/kWh**
- ❑ Approved O&M costs for DISCOMs accounted for ~**6-21% of ACoS** for 12 states for FY 2020-21
 - Expenditure on O&M per 1000 units of energy handled varied in the range of **300-1,000**
 - In Uttarakhand, expenditure on O&M costs is low mainly due to periodical **preventive maintenance of the feeders** and conductor augmentation activities conducted by the DISCOM
 - In Gujarat, expenditure on O&M costs is low mainly due to adoption of **Substation Automation System**¹ and deployment of **GIS and Hybrid switchgear**²
- ❑ Approved I&F charges for DISCOMs accounted for ~**1-10% of ACoS** for 12 states for FY 2020-21

¹ Human interface at limited points - Manpower optimization

² Maintenance free and economical on life cycle cost basis

Other factors



Retiring old coal based TPPs



Old TPPs: More than 30 years old

Hypothesis: Retiring of old power plants may lead to significant reduction in electricity tariff

❑ List of TPPs more than 30 Years Old, as on 31.03.2020 (1/2)

Sl. No.	State	Sector	Owner	Name of Project	Prime Mover	Unit No.	Total Units	Installed Capacity (MW)	Year of Comm.
1	UP	State Sector	UPRVUNL	ANPARATPS	Steam	1 to 3	3	630	1986 to 1989
2	UP	State Sector	UPRVUNL	HARDUAGANJ TPS	Steam	7	1	105	1978
3	UP	State Sector	UPRVUNL	OBRA TPS	Steam	7	1	94	1974
4	UP	State Sector	UPRVUNL	OBRA TPS	Steam	9 to 13	5	1,000	1977 to 1982
5	UP	State Sector	UPRVUNL	PARICHHA TPS	Steam	1 & 2	2	220	1984, 1985
6	UP	Central Sector	NTPC	RIHAND STPS	Steam	1 & 2	2	1,000	1988, 1989
7	UP	Central Sector	NTPC	SINGRAULI STPS	Steam	1 to 7	7	2,000	1982 to 1987
8	UP	Central Sector	NTPC	TANDA TPS	Steam	1 to 3	3	330	1988 to 1990
9	UP	Central Sector	NTPC	UNCHA HAR TPS	Steam	1 & 2	2	420	1988, 1989
10	UP	Central Sector	NTPC	AURAIYA CCPP	GT-Gas	1 to 6	6	663	1989, 1990
11	Gujarat	State Sector	GSECL	UKAI TPS	Steam	3 to 5	3	610	1979, 1985
12	Gujarat	State Sector	GSECL	WANAKBORI TPS	Steam	1 to 6	6	1,260	1982 to 1987
13	Gujarat	Private Sector	Torrent Power Ltd	SABARMATI (D-F STATIONS)	Steam	1 to 3	3	360	1978 to 1988

Old TPPs: More than 30 years old

Hypothesis: Retiring of Old Power Plants may lead to significant reduction in Electricity Tariff

❑ List of TPPs more than 30 Years Old, as on 31.03.2020 (2/2)

Sl. No.	State	Sector	Owner	Name of Project	Prime Mover	Unit No.	Total Units	Installed Capacity (MW)	Year of Comm.
14	MP	State Sector	MPPGCL	SATPURA TPS	Steam	6 to 9	4	800	1979 to 1984
15	MP	Central Sector	NTPC	VINDHYACHAL STPS	Steam	1 to 5	5	1,050	1987 to 1990
16	AP	State Sector	APGENCO	Dr. N.TATARA O TPS	Steam	1 to 4	4	840	1979 to 1990
17	Karnataka	State Sector	KPCL	RAICHUR TPS	Steam	1 & 2	2	420	1985, 1986
18	Bihar	Central Sector	NTPC	BARAUNI TPS	Steam	6 & 7	2	210	1983
19	Bihar	Central Sector	KBUNL	MUZAFFARPUR TPS	Steam	1 & 2	2	220	1985
20	Odisha	Central Sector	NTPC	TALCHER (OLD) TPS	Steam	1 to 6	6	460	1967 to 1983
21	Assam	State Sector	APGCL	NAMRUP CCPP	GT-Gas	2 to 6, 8	6	99	1965 to 1985
Thermal Plants for 12 states selected for Study > 30 Years Old								12,791	

Installed Capacity (MW)		
Total All India Thermal + Hydro + Nuclear (MW) AS ON 31.03.2020	283,078	100%
Total All India Thermal (MW) AS ON 31.03.2020	230,600	81%
All India Thermal Plants > 30 Years Old (MW)	27,334	12%
Thermal Plants for 12 states selected for Study > 30 Years Old (MW)	12,791	6%

Retiring old coal based TPPs: Andhra Pradesh

Hypothesis: Retiring of old power plants may lead to significant reduction in electricity tariff

- ❑ Detailed analysis of key parameters (as per norms) of old vs. latest coal based Thermal Power Plants

State	Sector	Owner	Name of Project	Prime Mover	Unit No.	Total Units	Installed Capacity (MW)	Year of Comm.
Andhra Pradesh	State Sector	APGENCO	Dr. N.TATARAOTPS	Steam	1 to 4	4	840	1979 to 1990

Dr. N.TATARAOTPS - Particulars	Unit	Actual Norms, as per TO	Norms, as per TO applicable for Latest Generating Station
Installed Capacity	MW	840	840
Plant Load Factor (%)	%	80%	80%
Gross Generation	MU	5886.72	5886.72
Auxiliary Consumption	%	9.00%	8.50%
Net Generation	MU	5,356.92	5,386.35
Station Heat Rate	kCal/kWh	2550	2430
Secondary Fuel Oil Consumption	ml/kWh	NA	NA
Price of oil	Rs./kL	NA	NA
Price of coal	Rs./MT	3,450.00	3,450.00
Energy Charge Rate (Ex-bus)	Rs./kWh	2.92	2.77
Reduction in Energy Charge Rate @ (Ex-bus)			5%

- ❑ There is a reduction of about 5% in the Energy Charges, in case the norms for latest thermal generating station is applied to old thermal generating station which is more than 30 years old.
- ❑ There is an Old Coal based TPPs having capacity of 840 MW, the same can be discontinued as there is an energy surplus of ~ 7,800 MU or ~ 890 MW, which leads to significant reduction in Electricity Tariff.

Energy Availability & Requirement						
State	FY	Energy Availability (MU)	Energy Requirement (MU)	Energy Surplus (MU)	Surplus in MW	Old Coal based TPPs (>30 Years Old), MW
AP	2018-19	68,672	60,843	7,829	893.72	840

Analysis for the states of GJ, MP, Bihar, Odisha and UP

Summary: Retiring old coal based TPPs

Hypothesis: Retiring of old power plants may lead to significant reduction in electricity tariff

- ❑ Thermal Plants > 30 Years Old account for **12% of the total installed capacity at the national level**
- ❑ Energy charges may reduce by **~4-23%** for 12 states in case the norms for latest thermal generating station are applied to old thermal generating station (> 30 years old)
- ❑ Old coal-based TPPs can be discontinued in the states of **Gujarat, Madhya Pradesh and Andhra Pradesh** as there is an energy surplus to the tune of 1,000 - 3,000 MW during FY 2018-19

Installed Capacity & Peak Demand



Installed Capacity & Peak Demand (GW)

Comparison of Region Wise Installed Capacity and Peak Demand (FY 2018-19)

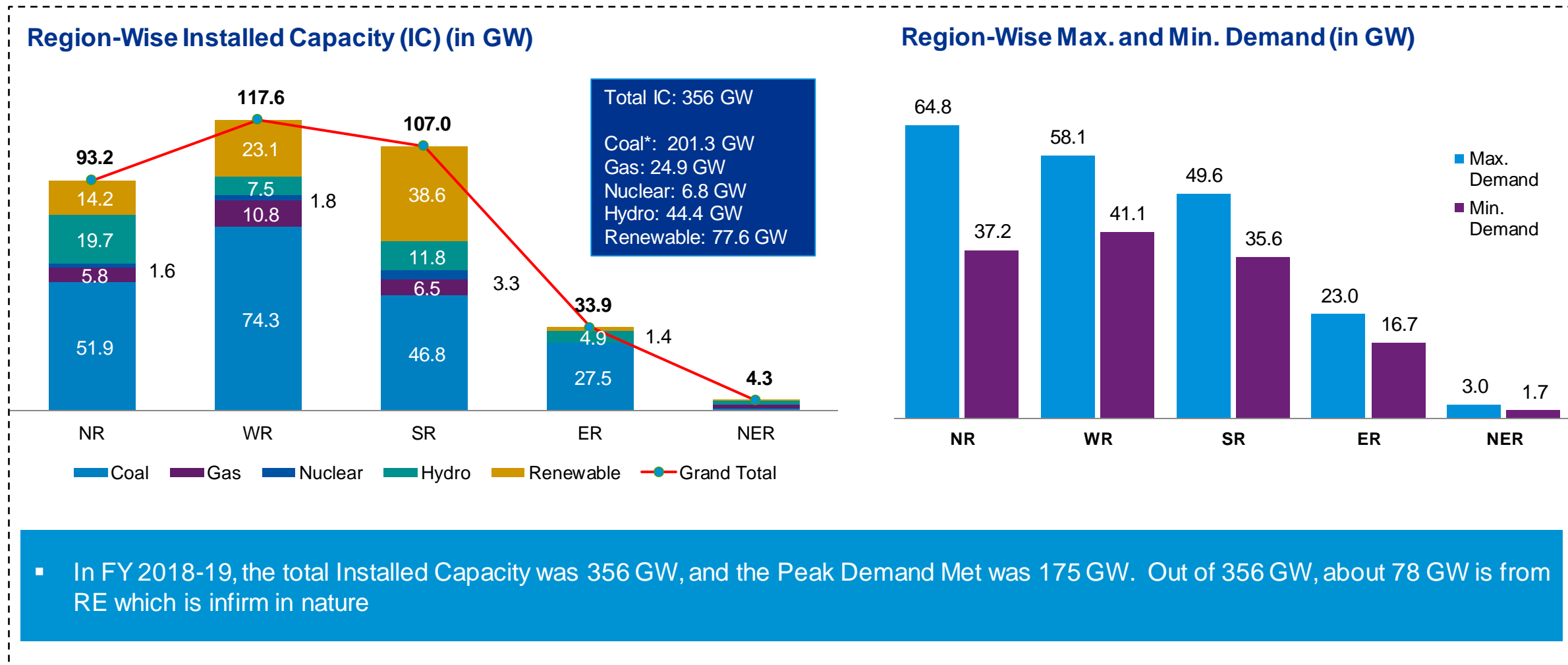

* Coal including Lignite and Diesel

Installed Capacity & Peak Demand (MW)

Comparison of Region Wise Installed Capacity and Peak Demand (FY 2019-20)

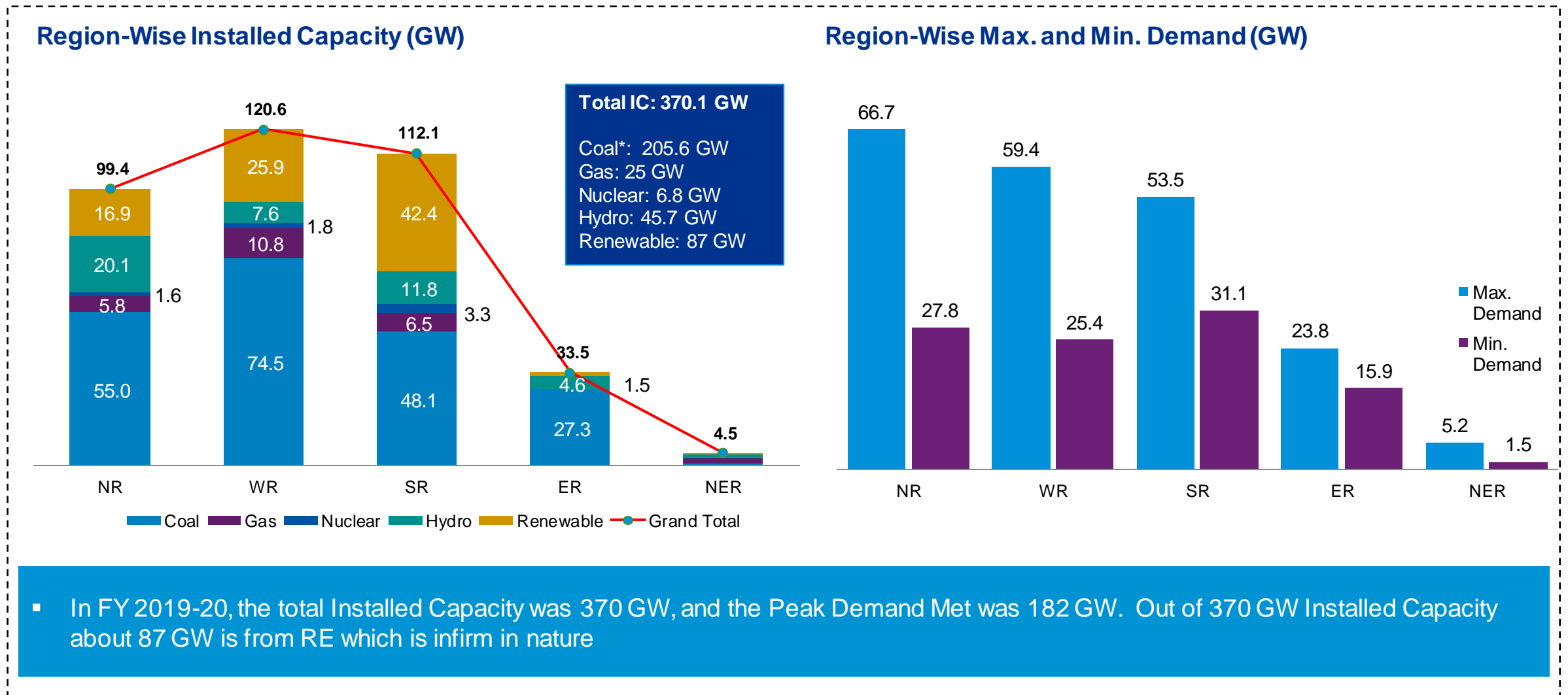

* Coal including Lignite and Diesel

Under-utilization of generating stations



Under-utilization of generating stations

Hypothesis: Optimal utilization of TPPs may lead to reduction in electricity tariffs

Reason for under-utilization of generating station

1 Shortage of coal

3 Not following Merit Order Dispatch properly

2 Generating plants running on technical minimum due to higher energy availability.

4 Targets set by Ministry of Power for RE procurement

Issue of coal shortage and technical minimum can be handled by retiring old coal based TPP as discussed in previous section. States like Madhya Pradesh, Gujarat, Andhra Pradesh etc. are surplus states.

Recently, MERC has issued guidelines for operation of Merit Order Dispatch under availability-based tariff order. Other states can examine the same in their state as per their Energy Gap scenario. Detailed regarding the guidelines issued by MERC are provided in subsequent slides. Proper implementation of MOD can improve the utilization of Generating Station.

Procurement of Renewable Energy is one of the reason for under-utilization of Generating Stations.

Stranded Cost of Power Purchase: Punjab

Breakup of Power Purchase Cost for FY 2018-19

Particulars	Energy Received by the Licensee	Variable Cost	Fixed Cost	Other Cost	Total Cost	
Unit	MUs	Rs. Crore	Rs. Crore	Rs. Crore	Rs. Crore	Rs./Unit
Thermal	37,017	9,346	5,147	134	14,628	3.95
Hydro	5,020	777	840	255	1,872	3.73
Renewable	2,200	1,443	-	10	1,452	6.60
Others	1,502	1,014	1,056	525	2,596	17.28
Total Power purchase	45,739	12,580	7,044	923	20,547	4.49
Less : Previous Year Payments	-	-	-	-	350	
Less: Disallowance for under achievement of Losses	-	-	-	-	228	
Less : Others	-	-	-	-	63	
Approved Power Purchase Cost	45,739	12,580	7,044	923	19,906	4.35

- Fixed charges contributed about 35% of PPC and Energy cost contributed about 63%
- Approved ARR for FY 2018-19 is Rs.30,620 Crore and PP Cost contributes 65 % of the ARR.

Source : Tariff Order for FY 2020-21

Stranded Cost of Power Purchase: Punjab

Details of Surrendered Power for FY 2018-19

Particulars	Units	Value
Energy Requirement	MU	57,277
Energy Availability	MU	65,848
Energy Surrendered	MU	8,571
Fixed Cost Paid	Rs. Crore	977
Actual Fixed Cost Per Unit Availed	Rs./Unit	1.41
Fixed Cost Per Unit (basis of total energy*)	Rs./Unit	1.14

Details of surrendered power						
Generating Stations	Energy Received (MU)	Energy Surrendered (MU)	Total Energy (MU)	Fixed Cost (Rs Crore)	Per Unit Fixed Cost of Energy Availed (Rs./unit)	Per Unit Fixed Cost for Total Energy (Availed + Surrendered) (Rs./unit)
NTPC Stations	5,614	2,481	8,095	712	1.27	0.88
IPP's	20,712	5,086	25,799	3,481	1.68	1.35
Pragati Gas Plant	246	586	832	92	3.72	1.10
DVC	2,997	210	3,207	570	1.90	1.78
UMPP's	7,485	207	7,692	367	0.49	0.48
Total	37,054	8,571	45,625	5,222	1.41	1.14

- The state has surrendered 8,571 MUs of power (15% of the total energy requirement in 2018-19)

Source: True-up petition for FY 2018-19

*Total energy is the computed as sum of energy availed and energy surrendered.

Stranded Cost of Power Purchase: Odisha

Details of Power Purchase

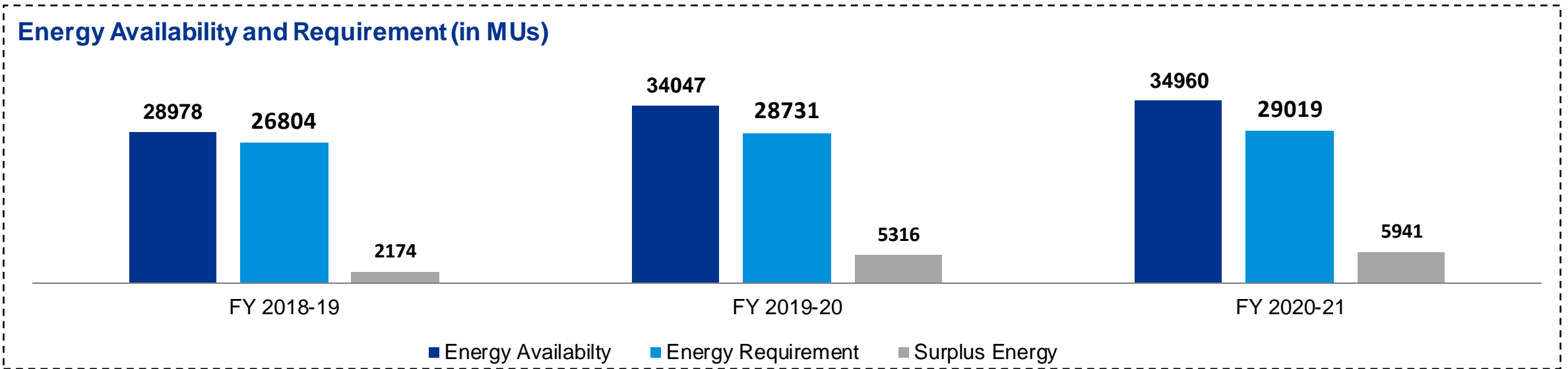

Power Purchase approved for GRIDCO(FY 2020-21)			
Particulars	MU	Rs. Crore	Rs./Unit
Thermal	19,730	5,729	2.90
Hydro	7,052	860	1.22
Renewable	2,237	866	3.87
Transmission Charges		629	
Total	29,019	8,084	2.79

- Surplus Energy is approximately 16-17% of the Energy availability for FY 20 and FY 21.

Stranded Cost of Power Purchase: Orissa

Details of Surrendered Power for FY 2020-21

Particulars	Units	Value
Energy Requirement	MU	29,019
Energy Availability	MU	34,960
Energy Surrendered	MU	5,941
Fixed Cost	Rs. Crore	348
Actual Fixed Cost Per Unit Availed	Rs./Unit	2.12
Fixed Cost Per Unit (basis of total energy)	Rs./Unit	0.92

Details of surrendered power						
Generating Stations	Energy Received (MU)	Energy Surrendered (MU)	Total Energy (MU)	Fixed Cost (Rs Crore)	Per Unit Fixed Cost of Energy Availed (Rs./unit)	Per Unit Fixed Cost for Total Energy (Availed + Surrendered) (Rs./unit)
Vedanta	3,053	1,986	5,039	399	1.31	0.79
TSTPS-1	1,509	677	2,186	219	1.45	1
FSTPS-I & II	-	1,542	1,542	132	-	0.86
FSTPS-III	-	586	586	91	-	1.54
KhTPS-I	-	880	880	96	-	1.09
KhTPS-II	-	269	269	30	-	1.13
Total	4,562	5,941	10,503	967	2.12	0.92

- The state has surrendered 5,941 MUs of power (17% of the total energy requirement in 2020-21)

Stranded Cost of Power Purchase : Madhya Pradesh

Breakup of Power Purchase Cost for FY 2019-20

Particulars	Energy Received by the Licensee	Variable Cost	Fixed Cost	Total Cost*	
Unit	MUs	Rs. Crore	Rs. Crore	Rs. Crore	Rs./Unit
Thermal	79,744	16,375	9,733	26,108	3.27
Hydro	5,798	-	1,343	1,343	2.32
Renewable	7,644	4,211	-	4,211	5.51
Others	2,282	673	-	673	2.95
Total Power purchase	95,468	21,259	11,076	32,335	3.39
Revenue for Surplus Power				9,888	
MPPMCL Cost				(730)	
Net Power Purchase Cost allowed	95,468	21,259	11,076	21,717	2.27

- Approved ARR for FY 2019-20 is Rs.32,797 Crore and PP Cost contributes 66 % of the ARR (excluding Transmission Charges).

Source : Tariff Order for FY 2019-20

* Per unit total cost has been estimated using input energy for the DISCOM

Stranded Cost of Power Purchase: Madhya Pradesh

Details of Surrendered Power for FY 2019-20

Particulars	Units	Value
Energy Requirement	MU	69,353
Energy Availability	MU	97,989
Energy Surrendered	MU	28,636
Fixed Cost of Surplus Energy	Rs. Crore	4,325
Actual Fixed Cost Per Unit Availed	Rs./Unit	1.11
Fixed Cost Per Unit (basis of total energy)	Rs./Unit	0.73

Details of surrendered power						
Generating Stations	Energy Received (MU)	Energy Surrendered (MU)	Total Energy (MU)	Fixed Cost (Rs Crore)	Per Unit Fixed Cost of Energy Availed (Rs./unit)	Per Unit Fixed Cost for Total Energy (Availed + Surrendered) (Rs./unit)
NTPC Stations	26,947	7,062	34,010	3,141	1.17	0.92
IPP's	22,815	19,053	41,868	2,396	1.05	0.57
Others		2,521				
Total	49,762	28,636	75,877	5,537	1.11	0.73

- The surplus energy is around 29% of the energy availability
- As per the tariff order for 2019-20, the State Commission has approved sale of surplus energy (25,658 MU) through power exchange at Rs. 3.85/unit leading to an additional revenue of Rs.9,888 Crore.

Stranded Cost of Power Purchase : JBVNL, Jharkhand

Breakup of Power Purchase Cost for FY 2020-21

Particulars	Energy Received by the Licensee	Variable Cost	Fixed Cost	Total Cost	
Unit	MUs	Rs. Crore	Rs. Crore	Rs. Crore	Rs./Unit
Thermal	9,206	1,902	1,898	3,800	4.13
Hydro	910	154	53	208	2.28
Renewable	1,632	535	-	535	3.28
Total Power purchase	11,749	2,591	1,951	4,543	3.87

Particulars	Units	Value
Energy Availability*	MU	17,059
Energy Requirement	MU	11,372

Ratio of Surplus Fixed Cost to ARR		
Particulars	Units	
Approved Sales for FY 2020-21	MU	9,894
Approved ARR	Rs. Crore	6,326
Approved ACoS	Rs./Unit	6.39
Fixed Cost for Surplus Power	Rs. Crore	563
Ratio of Fixed Cost Paid to ARR	%	8.90%

- Approved ARR for FY 2020-21 is Rs.6,326 Crore and PP Cost contributes 72 % of the ARR (excluding Transmission Charges).

Source : Tariff Order for FY 2020-21

*Energy availability has been estimated by considering on the basis of previous year's generation from tied-up power plants (including Central, State-owned and other Generating Stations)

Stranded Cost of Power Purchase : Assam

Breakup of Power Purchase Cost for FY 2018-19

Particulars	Energy Received by the Licensee	Fixed Cost	Variable Cost	Other Cost	Total Cost	
Unit	MUs	Rs. Crore	Rs. Crore	Rs. Crore	Rs. Crore	Rs./Unit
Thermal	6,604	1,299	1,475		2,774	4.20
Hydro	1,541	202	220		421	2.74
Renewable	92	-	53		53	5.74
Others	1,493	4	641	51	696	4.66
Total Power purchase	9,730	1,505	2,388	51	3,944	4.05
Transmission Charges					1,161	
Less: Delayed Payment Surcharge					36	
Net Power Purchase Cost allowed	9,730	1,505	2,388	51	5,069	5.21

- Approved ARR for FY 2018-19 is Rs. 5,374 Crore and PP Cost contributes 94% of the ARR including Transmission Charges and 73 % excluding Transmission Charges.

Source : True up Order for FY 2018-19

Stranded Cost of Power Purchase: Assam

Details of Surrendered Power for FY 2018-19

Particulars	Units	Value
Energy Requirement	MU	8,866
Energy Availability	MU	9,730
Energy Surplus	MU	864
Fixed Cost of Surplus Energy	Rs. Crore	294*
Actual Per Unit Fixed Cost	Rs./Unit	3.40
Fixed Cost Per Unit (basis of total energy)	Rs./Unit	2.19

Ratio of Surplus Fixed Cost to ARR		
Particulars	Units	
Approved Sales for FY 2018-19	MU	6,968
Approved ARR	Rs. Crore	5,374
Approved ACoS	Rs./Unit	7.71
Fixed Cost for Surplus Power	Rs. Crore	294*
Ratio of Fixed Cost Paid to ARR	%	5.47%

- The Surplus Energy is around 9% of the energy availability; The income earned from the sale of Surplus Power is **Rs.171 Crore @ Rs. 1.97 per Unit.**
- Impact of Surplus Power on ACOS is around **42 paise/unit.**

Source : True up Order for FY 2018-19

*Computed based on assumptions

Stranded Cost of Power Purchase : Uttarakhand

Breakup of Power Purchase Cost for FY 2020-21

Particulars	Energy Received by the Licensee	Variable Cost	Fixed Cost	Total Cost	
Unit	MUs	Rs. Crore	Rs. Crore	Rs. Crore	Rs./Unit
Thermal	6,225	1,991	734	3,800	4.13
Hydro	6,312	953	577	208	2.28
Renewable	1,477	672	-	535	3.28
Others	282	101	-		
Total Power purchase	14,295	3,717	1,311	5,028	3.52
Short Term (Tied Up) & Deficit Purchase	487	195			
Banking including OA Charges	49	30			
Net Power Purchase Cost allowed	14,832	3,942	1,311	5,252	3.54

Particulars	Units	Value
Energy Requirement	MU	14,832
Energy Availability	MU	14,295
Energy Deficit	MU	536

- Approved ARR for FY 2020-21 is Rs.6,957 Crore and PP Cost contributes 75% of the ARR.

Stranded Cost of Power Purchase: Bihar

Breakup of Power Purchase Cost for FY 2020-21

Particulars	Energy Received by the Licensee	Fixed Cost	Variable Cost	Other Cost	Total Cost	
Unit	MUs	Rs. Crore	Rs. Crore	Rs. Crore	Rs. Crore	Rs./Unit
Thermal	25,425	5,489	5,552	135	11,175	4.40
Hydro	3,117	150	833		983	3.15
Renewable	3,026	-	1,084		1,084	3.58
Others	816	-	342		342	4.19
Total Power purchase	32,384	5,639	7,811	135	13,584	4.19

- Approved ARR for FY 2020-21 is Rs. 18,528 Crore and PP Cost contributes 73% of the ARR excluding Transmission Charges

Stranded Cost of Power Purchase: Bihar

Details of Surrendered Power for FY 2020-21

Particulars	Units	Value
Energy Requirement	MU	32,384
Energy Availability	MU	46,686
Energy Surplus	MU	14,301
Fixed Cost of Surplus Energy	Rs. Crore	1,294*
Actual Fixed Cost Per Unit Availed	Rs./Unit	1.95
Fixed Cost Per Unit (basis of total energy)	Rs./Unit	1.26

Details of surrendered power						
Generating Stations	Energy Received (MU)	Energy Surrendered (MU)	Total Energy	Fixed Cost (Rs Crore)	Per Unit FC of Energy Availed (Rs./unit)	Per Unit FC of Total Energy (Availed + Surrendered) (Rs./unit)
CGS	22,398	11,507	33,905	4,311	1.92	1.27
SGS	3,484	2,794	6,278	742	2.13	1.18
Total	25,882	14,301	40,183	5,053	1.95	1.26

- The surplus energy is around 31% of the energy availability,

*Computed on the basis of Station wise Surplus Energy

Source : Tariff Order for FY 2020-21

Stranded Cost of Power Purchase: Uttar Pradesh

Breakup of Power Purchase Cost for FY 2020-21

Particulars	Energy Received by the Licensee	Fixed Cost	Variable Cost	Total Cost	
Unit	MUs	Rs. Crore	Rs. Crore	Rs. Crore	Rs./Unit
Thermal	101,328	19,863	24,366	44,229	4.36
Hydro	13,899	2,911	2,476	5,387	3.88
Renewable	7,523	-	3,088	3,088	4.10
Others	8,994	-	605	605	0.67
Total Power purchase	131,744	22,774	30,535	53,309	4.05

- Approved ARR for FY 2020-21 is Rs. 65,175 Crore and PP Cost contributes 82% of the ARR excluding Transmission Charges

Stranded Cost of Power Purchase: Uttar Pradesh

Details of Surrendered Power for FY 2020-21

Particulars	Units	Value
Energy Requirement	MU	1,09,328
Energy Availability	MU	1,31,744
Energy Surplus	MU	22,416
Fixed Cost of Surplus Energy	Rs. Crore	4,394*
Actual Per Unit Fixed Cost	Rs./Unit	1.96
Fixed Cost Per Unit (basis of total energy)	Rs./Unit	1.61

Ratio of Surplus Fixed Cost to ARR		
Particulars	Units	
Approved Sales	MU	92,409
Approved ARR	Rs. Crore	65,175
Approved ACoS	Rs./Unit	7.05
Fixed Cost for Surplus Power	Rs. Crore	4,394*
Ratio of Fixed Cost Paid to ARR	%	6.74%

- The surplus energy is around 17% of the energy availability,
- Impact of surplus power on ACOS is 6.74% (47 paise/unit)

*Computed on the basis of Fixed Cost per Unit of Thermal Energy

Source : Tariff Order for FY 2020-21

Stranded Cost of Power Purchase : Haryana

Breakup of Power Purchase Cost for FY 2020-21

Particulars	Energy Received by the Licensee	Fixed Cost	Variable Cost	Total Cost	
Unit	MUs	Rs. Crore	Rs. Crore	Rs. Crore	Rs./Unit
Thermal	51,354	5,937	15,554	21,491	4.18
Hydro	7,984	912	1,273	2,185	2.74
Renewable	3,588	-	1,251	1,251	3.49
Others	740	4	273	276	3.73
Total Power purchase	63,667	6,852	18,351	25,203	3.96
Approved PP Cost				20,868	3.28

- Approved ARR for FY 2020-21 is Rs. 27,836 Crore and PP Cost contributes 75% of the ARR excluding Transmission Charges

Stranded Cost of Power Purchase: Haryana

Details of Surrendered Power for FY 2020-21

Particulars	Units	Value
Energy Requirement	MU	48,796
Energy Availability	MU	63,667
Energy Surplus	MU	14,870
Fixed Cost of Surplus Energy	Rs. Crore	1,719*
Actual Per Unit Fixed Cost	Rs./Unit	1.16
Fixed Cost Per Unit (basis of total energy)	Rs./Unit	0.90

Ratio of Surplus Fixed Cost to ARR		
Particulars	Units	
Approved Sales	MU	38,474
Approved ARR	Rs. Crore	27,836
Approved ACoS	Rs./Unit	7.23
Fixed Cost for Surplus Power	Rs. Crore	1719*
Ratio of Fixed Cost Paid to ARR	%	6.18%

- The surplus energy is around 23% of the energy availability,
- Impact of surplus power on ACOS is 6.18% (45 paise/unit)

*Computed on the basis of Fixed Cost per Unit of Thermal Energy

Source : Tariff Order for FY 2020-21

Stranded Cost of Power Purchase : Andhra Pradesh

Breakup of Power Purchase Cost for FY 2020-21

Particulars	Energy Received by the Licensee	Fixed Cost	Variable Cost	Total Cost	
Unit	MUs	Rs. Crore	Rs. Crore	Rs. Crore	Rs./Unit
Thermal	50,545	7,894	16,016	23,910	4.73
Hydro	3,169	601	-	601	1.90
Renewable	14,392	-	6,597	6,597	4.58
Others	795	984	175	1,159	14.57
Total Power purchase	68,902	9,479	22,788	32,268	4.68

- Approved ARR for FY 2020-21 is Rs. 42,494 Crore and PP Cost contributes 76% of the ARR excluding Transmission Charges

Stranded Cost of Power Purchase: Andhra Pradesh

Details of Surrendered Power for FY 2020-21

Particulars	Units	Value
Energy Requirement	MU	68,902
Energy Availability	MU	78,406
Energy Surplus	MU	9,504
Fixed Cost of Surplus Energy	Rs. Crore	917*
Actual Fixed Cost Per Unit Availed	Rs./Unit	2.41
Fixed Cost Per Unit (basis of total energy)	Rs./Unit	1.88

Details of surrendered power						
Generating Stations	Energy Received (MU)	Energy Surrendered (MU)	Total Energy (MU)	FC (Rs Crore)	Per Unit FC of Energy Availed (Rs./unit)	Total Per Unit FC (Rs./unit)
NTPC Stations	21,510	7,928	29,437	5,048	2.35	1.71
IPP's	12,017	1,577	13,594	3,043	2.53	2.24
Total	33,527	9,504	43,031	8,090	2.41	1.88

- The surplus energy is around 12% of the energy availability,

*Computed on the basis of Fixed Cost per Unit of Station wise Thermal Energy

Source : Tariff Order for FY 2020-21

Stranded Cost of Power Purchase: Gujarat

Breakup of Power Purchase Cost for FY 2020-21

Particulars	Energy Received by the Licensee	Fixed Cost	Variable Cost	Total Cost	
Unit	MUs	Rs. Crore	Rs. Crore	Rs. Crore	Rs./Unit
Thermal	88,217	12,017	19,173	31,190	3.54
Hydro	599	115	-	115	1.92
Renewable	16,533	40	6,813	6,853	4.15
Others	302	-	121	121	4.02
Total Power purchase	105,652	12,173	26,105	38,277	3.62

- Approved ARR for FY 2020-21 is Rs. 51,712 Crore and PP Cost contributes 74% of the ARR excluding Transmission Charges

Stranded Cost of Power Purchase: Gujarat

Details of Surrendered Power for FY 2020-21

Particulars	Units	Value
Energy Requirement	MU	1,05,652
Energy Availability	MU	1,16,872
Energy Surplus	MU	11,220
Fixed Cost of Surplus Energy	Rs. Crore	1,528*
Actual Per Unit Fixed Cost	Rs./Unit	1.36
Fixed Cost Per Unit (basis of total energy)	Rs./Unit	1.21

Ratio of Surplus Fixed Cost to ARR		
Particulars	Units	
Approved Sales	MU	87,824
Approved ARR	Rs. Crore	51,712
Approved ACoS	Rs./Unit	5.89
Fixed Cost for Surplus Power	Rs. Crore	1,528*
Ratio of Fixed Cost Paid to ARR	%	2.96%

- The surplus energy is around 10% of the energy availability,
- Impact of surplus power on ACOS is 2.96% (17 paise/unit)

*Computed on the basis of Fixed Cost per Unit of Thermal Energy

Source : MTR for FY 2019-20 to FY 2020-21

Stranded Cost of Power Purchase: Kerala

Breakup of Power Purchase Cost for FY 2020-21

Particulars	Energy Received by the Licensee	Fixed Cost	Variable Cost	Other Cost	Total Cost	
Unit	MUs	Rs. Crore	Rs. Crore	Rs. Crore	Rs. Crore	Rs./Unit
Thermal	19,975	3,090	5,293	(119)	8,264	4.14
Hydro	88	-	-		31	3.48
Renewable	1,397	-	-		384	2.75
Others	385	-	-		216	5.62
Total Power purchase	21,845	3,090	5,293	(119)	8,895	4.07

- Approved ARR for FY 2020-21 is Rs. 15,936 Crore and PP Cost contributes 56% of the ARR excluding Transmission Charges

Stranded Cost of Power Purchase: Kerala

Details of Surrendered Power for FY 2020-21

Particulars	Units	Value
Energy Requirement	MU	26,674
Energy Availability	MU	27,456
Energy Surplus	MU	782
Fixed Cost of Surplus Energy	Rs. Crore	121*
Actual Per Unit Fixed Cost	Rs./Unit	1.55
Fixed Cost Per Unit (basis of total energy)	Rs./Unit	1.49

Ratio of Surplus Fixed Cost to ARR		
Particulars	Units	
Approved Sales	MU	23,454
Approved ARR	Rs. Crore	15,936
Approved ACoS	Rs./Unit	6.77
Fixed Cost for Surplus Power	Rs. Crore	121*
Ratio of Fixed Cost Paid to ARR	%	0.76%

- The Surplus Energy is around 3% of the Energy Availability
- Impact of Surplus Power on ACOS is 0.76%

*Computed on the basis of Fixed Cost per Unit of Thermal Energy

Source : Revised Forecast for FY 2020-21 to FY 2021-22 issued by KERC

Stranded Cost of Power Purchase: Summary

Ratio of Fixed Cost Paid to ARR

Ratio of Surplus Fixed Cost to ARR		
State	Year	Fixed Cost Paid for Surplus Power (in Rs. Crore)
Madhya Pradesh	FY 2019-20	4,325
Jharkhand	FY 2020-21	563
Bihar	FY 2020-21	1,294
Uttar Pradesh	FY 2020-21	4,394
Haryana	FY 2020-21	1,719
Assam	FY 2018-19	294
Punjab	FY 2018-19	977
Odisha	FY 2020-21	348
Gujarat	FY 2020-21	1,528
Andhra Pradesh	FY 2020-21	917
Kerala	FY 2020-21	121
Total		16,480

- Fixed cost paid for surplus power varied in the range of 1-13% of the total ARR for the 12 states

Summary: Under-utilization of generating stations

Hypothesis: Optimal utilization of TPPs may lead to reduction in electricity tariffs

- ❑ Under-utilization of generating stations could be attributed to various factors such as shortage of coal, non-compliance with Merit Order Dispatch, generating plants running on technical minimum due to higher energy availability, etc.
- ❑ Fixed cost paid for surplus power for 12 states was about **Rs 16,480 crores** varying in the range of **1-13% of the total ARR** for the 12 states

Maharashtra: Merit Order Dispatch (MOD) guidelines

Maharashtra Electricity Regulatory Commission (MERC) issued guidelines for operation of Merit Order Dispatch (MOD) under availability-based tariff order. These guidelines came into effect from the month of April 2019.

The following key aspects have been identified and addressed in the guidelines:

Guidelines for Reserve Shut Down (RSD) instructions to the Generating Units.

Guidelines for Zero Schedule instructions to the Generating Units.

Other aspects:

- Periodicity and date of preparation of MOD stack.
- Basis of preparation of MOD stack, including the variable charge to be considered
- Guidelines for operating the Generating Units.
- Guidelines for capacity declaration by Generating units
- Identification of Must Run Stations, and guidelines for operating Hydro Stations
- Technical Minimum of Generating Units.

[Detailed Guidelines](#)

Compliance of new environmental norms



Benchmarking of capital cost for FGD-capital cost specified by CEA

- CEA has specified an indicative capex cost¹ in Rs. lakh/MW for FGD installation for various unit sizes and it is discovered through open competitive bidding for the projects already awarded
- CEA has specified that the Base Cost may further vary as per the following conditions:
 - No. of Units
 - Range of SO₂ removal
 - Chimney Layout such as using existing chimney as wet stack, new wet stack with single or multi flue cans, Chimney above absorber, and chimney material
 - Choice of Corrosion protection lining in chimney, absorber and other sections of FGD.
- Also, the cost may further come down in future due to increased number of vendors/suppliers as the market matures.

FGD Base Cost specified by CEA

Capacity Group (MW)	CAPEX (Rs. Lakh/MW)
210	45
250	
300	43.5
500	40.5
525	
600	37
660	
800	30
830	

¹This capex is "Base Cost" only with cost of new chimney and does not include Taxes-Duties and IDC

Benchmarking of capital cost for FGD- capital cost petitioned by DISCOMs

- Cost estimates projected by the other generating stations for installing FGD system are provided in the Table
- **CERC has considered the Capital Cost (CC) range of Rs. 43- 75 lakh/MW for various CGS**
- For Tiroda TPS, MERC has considered CC of Rs. 65 lakh/MW
- For Rosa plant, the petitioner has requested approval of CC of Rs. 0.60 Crore/MW¹

Cost specified by CSE

- CSE² in its publication³ cited the cost of FGD as Rs. 50 to 60 lakh/MW.

Total Cost including Taxes and IDC

Sr. No.	Name of Generating Station	Installed Capacity	Estimated Cost		Reference
1	Vindhyachal Super Thermal Power Station Stage V	500 MW	Rs. 201.30 Crore	Rs. 0.40 Crore/MW	CERC Order dated 31.08.2016 in Petition No. 234/GT/2015
2	Rosa Power Supply Company Ltd.	1200 MW	Rs. 730.49 Crore	Rs. 0.60 Crore/MW	UPERC Order dated 16.01.2020 in Petition No. 1465 of 2019
3	Maithon Power Ltd.	1050 MW	Rs. 777.14 Crore	Rs. 0.74 Crore/MW	CERC Order dated 11.11.2019 in Petition No. 152/MP/2019
4	Bongaigaon Thermal Power Station Unit 1	250 MW	Rs. 108 Crore	Rs. 0.43 Crore/MW	CERC Order dated 22.05.2017 in Petition No. 45/GT/2016
5	Udupi Thermal Power Station	1200 MW	Rs.899 Crore	Rs. 0.75 Crore/MW	CERC Order dated 20.11.2019 in Petition No. 346/MP/2018
6	Adani Power Maharashtra Ltd- Tiroda TPS	3300 MW	Rs. 2159 Crore	Rs. 0.65 Crore/MW	MERC Order dated 06.02.2019 in Case No. 300 of 2018
7.	Sasan Power Limited	3960 MW	Rs. 2434 Crore	Rs. 0.615 Crore/ MW	CERC Order dated 23.04.2020 in Petition No. 446/MP/2019

Total Cost in range of Rs 40-75 lakh/MW may be considered for evaluating DPRs by SERCs

¹The commission has not approved the capital cost because additional capital cost approval due to change in law can be considered only after compliance and prudence check as per UPERC Generation Tariff Regulations 2019

² Centre of Science and Environment

³ Released during the conference titled 'New Environmental Norms: The Way Forward' held on 7 September 2016

CERC staff paper on FGD

Additional Capital Expenditure (ACE-ECS)

- Additional capital expenditure include **base cost of Emission Control Systems (ECS), taxes and duties, IDC and miscellaneous costs associated with installation of ECS.**
- Increase in monthly tariff spread over useful life of the ECS through Supplementary Capacity Charges (SCC) which includes:
 - a) Depreciation (ACEDep)
 - Life of 25 years 90% (considering salvage value of 10%) of additional CAPEX on account of installation of ECS is proposed to be recovered by the generating company in 25 years as depreciation {straight line method @3.6% (90%/25) per year} starting from date of operation of ECS.
 - b) Cost of Capital Employed for ECS (ACEcoc)
 - Additional CAPEX on installation of emission control system is proposed to be serviced on Net Fixed Assets (NFA) basis (value of fixed assets reducing each year by the depreciation value) @ weighted average rate of interest of loans raised by the generator or at the rate of Marginal Cost of Lending Rate of State Bank of India (for one-year tenure) plus 350 basis points, as on 1st April of the year in which emission control system is put into operation, whichever is lower.

Note: Where the technology is installed with "Gas to Gas" heater, AUX specified above shall be increased by 0.3% of gross generation

CERC staff paper on FGD

Norms for O&M expenses & working capital

Additional O&M Expenses

- First year O&M expenses @2% of capital expenditure for installation of FGD (excluding IDC and FERV) admitted by the Commission after prudence check.
- For subsequent years, the first year O&M expenses may be escalated @3.5% or any other escalation rate as may be specified by the Commission

Additional Working Capital

- Working Capital may include:
 - i) Cost of limestone or reagent towards stock for 20 days corresponding to the normative annual plant availability factor and advance payment for 30 days towards cost of reagent for generation corresponding to the normative annual plant availability factor;
 - ii) Operation and maintenance expenses in respect of emission control system for one month and maintenance spares @20% of operation and maintenance expenses in respect of emission control system; and
 - iii) Receivables equivalent to 45 days of supplementary capacity charge and supplementary energy charge for sale of electricity calculated on the normative annual plant availability factor.

CERC staff paper on FGD

Auxiliary consumption

Auxiliary consumption

Name of Technology	AUX (as % of Gross Generation)
a) Wet Limestone based FGD system (without Gas to Gas heater)	1.0%
b) Lime Spray Dryer or Semi dry FGD System	1.0%
c) Dry Sorbent Injection System (using Sodium bicarbonate)	NIL
d) For CFBC Power plant (furnace injection)	NIL
e) Sea water based FGD system (without Gas to Gas heater)	0.7%

Note: Where the technology is installed with “Gas to Gas” heater, AUX specified above shall be increased by 0.3% of gross generation

Estimated impact on tariff

- Impact on tariff on account of Wet Limestone based FGD has been computed for a sample 3*500 MW of Thermal Power Project
- For impact of tariff, capital cost of Rs. 800.23 Crore (Rs 0.53 Lakh/MW) has been considered based on CEA specified base cost of Rs. 40.5 Lakh/MW for 500 MW Unit size and additional cost of Taxes-Duties and IDC
- Operation of plant has been considered for 25 years
- The total per unit Levelized Tariff Impact for 25 years works out to be around Rs. 0.247/kWh**

Impact on Tariff (Rs./kWh)

S. No.	Tariff Component	Levelized Tariff for 25 years (Rs./kWh)
1	<i>Differential energy charge (for additional Aux. cons. due to FGD)</i>	0.034
2	<i>Limestone cost</i>	0.098
A	Variable cost	0.132
3	<i>O&M cost</i>	0.015
4	<i>Interest on debt</i>	0.034
5	<i>Depreciation</i>	0.035
6	<i>Return on equity</i>	0.027
7	<i>IoWC</i>	0.004
B	Fixed cost	0.115
C	Total Impact on Tariff (A+B)	0.247

Tentative levelized Tariff Impact of around 20-30 paise/kWh may be considered by SERCs for evaluating DPRs

Phasing of FGD as per CEA concept paper

- CEA, in its Paper on “Plant Location Specific Emission Standards” has observed that there should be **graded action plan for adopting new emission norms for TPS** rather than adopting a single deadline for large base of power plants across the country
- CEA recommended that Phasing of FGD Installation should be done based on **Ambient Air Quality (AAQ) and SO₂ Levels** in that location
- CEA proposed to implement FGD for the thermal power plants region-wise as given in the table:
 - In areas where the development is high, the atmospheric air quality is poor and is prone to serious atmospheric pollution problems, strict control of emissions shall be required in such key areas for TPS as categorised under Region 1.
 - In next phase may be after one year commissioning of 1st phase units, observing the effectiveness of installed equipment, to be implemented in the power plant which are located under Region 2
 - Presently no action is required for power plant those are situated under Region 3,4 & 5

Phasing of FGD Installation based on Ambient Air Quality SO₂ Levels

Region	Ambient Air SO ₂ Levels	Remarks
1	Level - I (>40µg/m ³)	FGD shall be installed immediately
2	Level-II (>30µg/m ³ & ≤40µg/m ³)	FGD shall be installed in 2nd phase
3	Level-III (>20µg/m ³ & ≤30µg/m ³)	FGD is not required at present
4	Level-IV (>10µg/m ³ & ≤20µg/m ³)	FGD is not required at present
5	Level-V (>0µg/m ³ & ≤10µg/m ³)	FGD is not required at present

Phasing of FGD may be considered as per Ambient Air Quality in vicinity of Power Plant

Summary: Compliance of new environmental norms

- ❑ CEA has specified an indicative capex cost in Rs. lakh/MW for FGD installation for various unit sizes in the range of Rs. 30-45 Lakh/MW
- ❑ CERC has considered the Capital Cost (CC) range of **Rs. 43- 75 lakh/MW** for various CGS for installing FGD system
- ❑ Total per unit Levelized Tariff Impact for 25 years on account of Wet Limestone based FGD is estimated to be around **Rs. 0.247/kWh**
- ❑ CEA has observed that there should be **graded action plan** for adopting new emission norms for TPS rather than adopting a single deadline for large base of power plants across the country

Cost optimization through greater use of market



Cost optimization through greater use of market

Power Portfolio Cost Optimization: Benefits achieved post implementation in Rajasthan

1 Background

As a part of PSR program, one of the activities involved supporting the Rajasthan Urja Vikas Nigam Ltd (RUVNL) in:

- Optimizing power purchase costs,
- Institutionalizing power market intelligence and decision-making tools

Therefore, a '**Power Sale and Purchase Decision Support Tool**' has been developed and successfully deployed in Rajasthan.

2 Objective

- The key objective of this tool is to create a platform which provides a consolidated data repository of data for states (available in public domain) and triangulate between these data sets to aid in decision making and **uncovering market opportunities for trading in short and medium term.**
- The tool identifies the best trading partners and avenues for sale and purchase on the basis of the demand and supply side complementarity

3 Key Benefits

- Quantitative benefits of the tool are provided below:

Reduction in power procurement costs (A)	Rs. 315 Cr.¹
Increment in sale revenue on exchange (B)	Rs. 406 Cr.²
Estimated savings from sale of increased sale on exchange (C)	Rs. 40 Cr.³
Total Savings (A+C):	Rs. 355 Cr.
Annual Power Procurement Cost for FY 18-19	Rs. 27,804 Cr.⁴
Total savings as % of Annual Procurement Cost	1.3%
Reduction in per unit PPC due to savings from tool	5.9 Paise per unit⁵

¹ Analyzed for sample days from Nov'18 to Mar'19 and extrapolated over these 5 months.

² Average increment in % obtained using analysis of data for sample days between April'19 to Aug'19 and extrapolated using total annual sales from FY 18-19 (applying the % increment obtained on the last year's sale for the months between Sep & March)

³ A margin of 10% has been taken for calculation of profits on sale of power on exchange

⁴ Power purchase cost (after adjustment of sale of power). Source: ARR for Rajasthan for FY 2018-19 (Page 62)

⁵ The benefits have been extrapolated on a best guess basis. As the demand supply dynamics change on a day-to-day basis, the benefits observed of a given day / month may not be same as that of some other day / month. The benefits may significantly vary between the states.

Conclusion

Power purchase cost

- PPC accounts for ~67% to 78% of the total ACoS.
- Share of PPC in ACoS has reduced over the last 4 years, mainly due to increase in contribution of other cost components (such as O&M, interest & finance, depreciation, etc.)
- Fixed charges contribute around 25-40% whereas energy charges contribute around 60-70% to the overall PPC



Coal prices

- Coal price accounts for around 25% of landed cost of fuel.
- Coal prices (in last 4 yrs.) were about 28%¹ higher as compared to the price based on WPI and wt. avg. of WPI and CPI.



Railway freight

- Rail freight accounts for ~40% of landed cost of fuel
- Railway freight (in last 4 yrs.) was about ~30%² higher as compared to freight based on WPI and wt. avg. of WPI and CPI.



Clean Energy Cess

- Clean energy cess has increased from Rs. 50/Tonne in 2010 to Rs. 400/Tonne in 2016.
- Reduction of clean energy cess by Rs 50/MT may reduce the ACoS by around 3 paise per unit



Change in GCV

- Every 100 kcal/kg loss in GCV results in ~3% increase in energy charges



¹ Actual coal prices compared to coal prices based on WPI and wt. avg. of WPI & CPI during Jan' 2018

² Actual railway freight compared to freight based on WPI and wt. avg. of WPI & CPI during Nov' 2018

Conclusion

Depreciation

- Depreciation (for G, T & D utilities) accounted for 6% of the total ARR in FY 2020-21 for 12 states.
- Reduction of depreciation rate to 4.67% and 4.34% may reduce ACoS by Rs. 0.08kWh (1.2%) and Rs. 0.10kWh (1.4%) respectively



ROE

- ROE (for G, T & D utilities) accounted for 5% of the total ARR in FY 2020-21 for 12 states.
- Reduction of approved rate of ROE to 14% and 12% may reduce ACoS by Rs. Rs. 0.02/kWh (0.4%) and 0.07/kWh (1.0%) respectively



Distribution loss

- Approved distribution losses accounted for ~8% - 21% of ACoS for 12 states for FY 2020-21.
- Reduction of approved Distribution losses to 12% would reduce ACoS by Rs. 0.00-0.66/kWh (3%).



Transmission charges

- Inter-state transmission capacity has increased based on projected demand.
- Inter-state transmission charges have increased @ CAGR of 17% in last 10 years
- Competitive bidding has resulted in ~ 45-50% reduction in transmission charges



Other factors

- Retiring of inefficient old thermal power plants (>30 years old) may reduce energy charges by 4-23%.
- Fixed cost paid for surplus power for 12 states is about Rs 16 thousand crores varying in the range of 1-13% of the total ARR.
- The total per unit levelized tariff impact for 25 years due to FGD installation is estimated to be around Rs. 0.247/kWh



Thank You

Contact Details

Udit Mathur

Energy Adviser

Foreign, Commonwealth & Development Office

udit.mathur1 @fcdo.gov.uk

Anish De

Programme Director - Power Sector Reforms Programme

KPMG India

anishde@kpmg.com



Supporting Structural
Reforms in the
Indian Power Sector



<https://psrindia.com/>



https://twitter.com/psr_india



www.facebook.com/PSR-India-122338261759998/

Approved Power Purchase Cost for 12 States (Excluding Transmission Charges) for FY 2016-17 & FY 2017-18

S No.	States/UTs	2016-17		
		Sales (MU)	PPC (Rs. Cr)	PPC (Rs/kWh)
1	Uttarakhand	11,188	4,047	3.62
2	Assam	6,684	2,909	4.35
3	Kerala	20,626	7,818	3.79
4	Bihar	19,957	10,751	5.39
5	Madhya Pradesh	48,552	18,143	3.74
6	Odisha	19,302	6,703	3.47
7	Karnataka	52,769	22,649	4.29
8	Andhra Pradesh	49,991	21,151	4.23
9	Haryana	35,981	19,436	5.40
10	Jharkhand	8,651	4,489	5.19
11	Uttar Pradesh	94,599	50,698	5.36
12	Gujarat	69,658	29,266	4.20
	Total	437,958	198,060	4.52

S No.	States/UTs	2017-18		
		Sales (MU)	PPC (Rs. Cr)	PPC (Rs/kWh)
1	Uttarakhand	11,849	4,376	3.69
2	Assam	7,524	3,184	4.23
3	Kerala	21,840	7,453	3.41
4	Bihar	20,358	9,591	4.71
5	Madhya Pradesh	49,725	19,910	4.00
6	Odisha	19,775	6,969	3.52
7	Karnataka	54,699	22,776	4.16
8	Andhra Pradesh	50,077	21,491	4.29
9	Haryana	36,573	19,878	5.44
10	Jharkhand	9,223	4,859	5.27
11	Uttar Pradesh	92,094	48,017	5.21
12	Gujarat	85,962	31,215	3.63
	Total	459,699	199,719	4.34

[Back](#)

Approved Power Purchase Cost for 12 States (Excluding Transmission Charges) for FY 2018-19 & FY 2019-20

S No.	States/UTs	2018-19		
		Sales (MU)	PPC (Rs. Cr)	PPC (Rs/kWh)
1	Uttarakhand	11,888	4,930	4.15
2	Assam	7,784	3,235	4.16
3	Kerala	21,647	7,848	3.63
4	Bihar	22,527	12,370	5.49
5	Madhya Pradesh	52,652	20,287	3.85
6	Odisha	20,448	7,190	3.52
7	Karnataka	57,180	24,739	4.33
8	Andhra Pradesh	54,932	24,565	4.47
9	Haryana	36,549	20,654	5.65
10	Jharkhand	10,197	4,644	4.55
11	Uttar Pradesh	104,380	50,604	4.85
12	Gujarat	84,580	33,043	3.91
	Total	484,764	214,109	4.42

S No.	States/UTs	2019-20		
		Sales (MU)	PPC (Rs. Cr)	PPC (Rs/kWh)
1	Uttarakhand	12,938	5,176	4.00
2	Assam	7,930	3,821	4.82
3	Kerala	22,970	8,614	3.75
4	Bihar	27,512	12,875	4.68
5	Madhya Pradesh	55,638	21,718	3.90
6	Odisha	21,893	7,530	3.44
7	Karnataka	59,471	28,747	4.83
8	Andhra Pradesh	59,162	26,430	4.47
9	Haryana	41,786	21,207	5.08
10	Jharkhand	11,011	5,525	5.02
11	Uttar Pradesh	94,518	47,493	5.02
12	Gujarat	94,422	36,472	3.86
	Total	509,251	225,608	4.43

Estimation of national average power purchase cost data-CERC

State	Data Sources for APPC estimation for FY2019-20 by CERC	Source of data for analysis of key factors impacting tariff
J&K	No details available	PPC and transmission charges from retail tariff order for FY 2019-20.
Arunachal Pradesh	Tariff Order for FY 2018-19	
Bihar	PPC for FY2019-20 from APR order for FY 2019-20	
Jharkhand*	Power Purchase and Cost for FY2019-20 from APR Order for FY 2019-20 have been considered for JBVNL , TSL, TSUISL and DVC. For SAIL Bokaro, PPC for FY2019-20 has been considered from MYT Order for FY 2016-17 – FY 2020-21.	
Meghalaya	PPC for FY2019-20 from MYT Order for Control Period FY 2018-19 to FY 2020-21	
Nagaland	PPC for FY2019-20 from Order on review for the FY 2019-20 (20th March 2020)	
Tamil Nadu	PPC for FY2018-19 from Order on Determination of Tariff for Generation and Distribution (11th August 2017)	
Telangana	PPC for FY2018-19 from Tariff Order for FY 2018-19 (27th March 2018)	
Tripura	PPC for FY2019-20 from Order on ARR for FY 2016-17 – FY 2020-21 (1st Sep 2020)	
West Bengal	PPC from Tariff Orders of FY 2017-18	

*For the state of Jharkhand, only JBVNL has been considered for the PPC computation.

Transmission charges

Hypothesis: Inter-state transmission charges have increased disproportionately as compared to intra-state transmission charges

❑ Capital costs per ckt. Km for inter-state and intra-state transmission lines

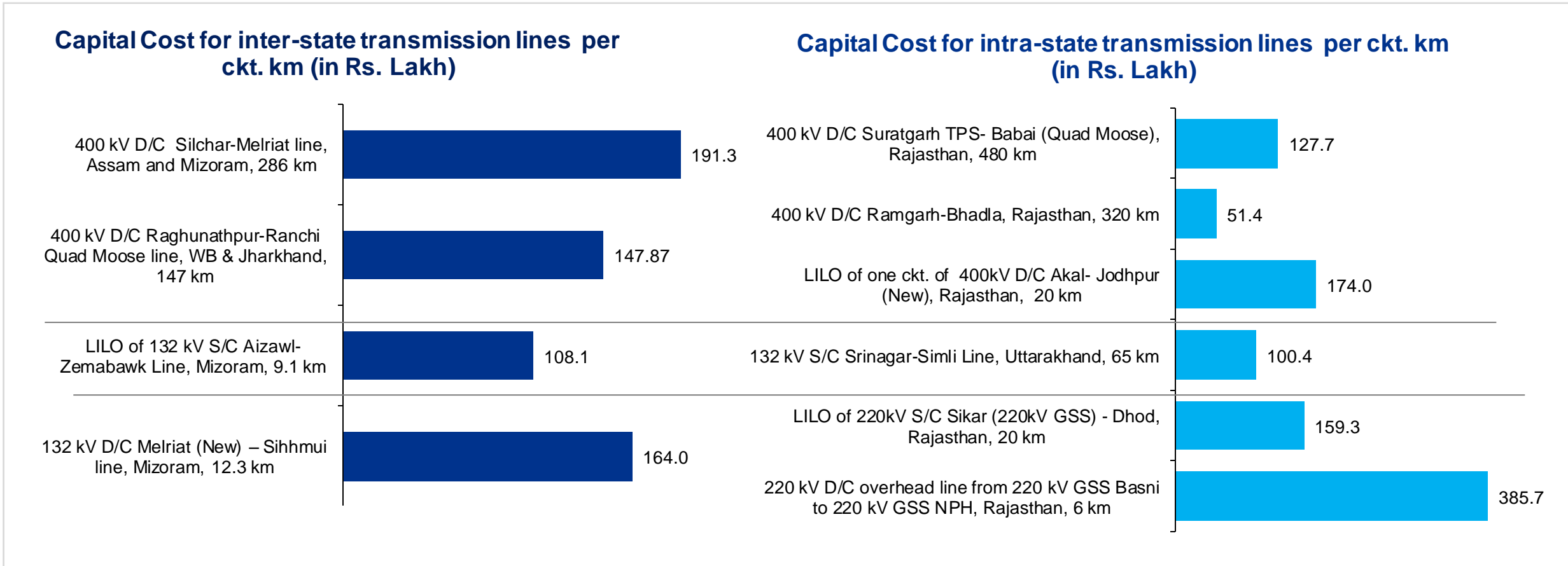

Capital costs per ckt. Km depends on the scope of transmission project (number of substations, transformation capacity, etc.).

*Source: Respective transmission tariff orders

Sector wise generation and inter state transmission charges

Sector wise generation (in MUs)	2011-12	2012-13	2013-14	2014-15	2015-16	2016-17	2017-18	2018-19	2019-20
Central (A)	364,005	375,970	384,905	395,110	409,343	433,744	449,512	461,125	460,268
State	367,953	347,154	350,403	366,803	344,995	350,938	377,726	401,132	387,966
Private	139,647	184,138	226,245	281,752	348,240	369,842	374,290	382,672	396,756
Imported	5,285	4,795	5,598	5,008	5,244	5,617	4,778	4,407	5,794
Grand Total	876,888	912,057	967,150	1,048,673	1,107,822	1,160,141	1,206,306	1,249,337	1,250,784

Year	2011-12	2012-13	2013-14	2014-15	2015-16	2016-17	2017-18	2018-19	2019-20
Annual Transmission charges (Rs Cr.) (B)	8,743	12,797	15,118	17,680	22,476	27,838	31,405	35,599	39,285
Per Unit transmission charges (B*10/A)	0.24	0.34	0.39	0.45	0.55	0.64	0.70	0.77	0.85

[Back](#)

State-wise ABR and ACoS values across the years

S. No.	State	2017-18			2018-19			2019-20			CAGR	
		ACoS	ABR	Gap	ACoS	ABR	Gap	ACoS	ABR	Gap	ACoS	ABR
1	Andhra Pradesh	5.54	5.54	0.00	5.88	5.88	0.00	6.06	6.06	0.00	4%	4%
2	Assam	7.42	7.35	0.07	7.35	6.68	0.67	7.05	7.05	0.00	6%	5%
3	Bihar	6.70	7.12	(0.42)	7.21	7.16	0.05	6.59	7.14	(0.55)	6%	9%
4	Gujarat	5.19	5.63	(0.44)	5.89	5.70	0.19	5.98	5.68	0.30	3%	1%
5	Haryana	5.43	5.50	(0.06)	6.10	6.13	(0.03)	5.59	5.72	(0.13)	4%	2%
6	Jharkhand	6.63	6.48	0.16	7.24	7.89	(0.65)	6.51	5.69	0.81	2%	3%
7	Karnataka	6.41	6.41	0.00	6.75	6.75	0.00	7.20	7.20	0.00	7%	7%
8	Kerala	5.05	5.53	(0.48)	6.11	6.09	0.02	6.51	6.55	(0.04)	6%	7%
9	Madhya Pradesh	6.25	6.25	0.00	6.03	6.03	0.00	6.59	6.59	0.00	4%	4%
10	Odisha	4.69	4.70	(0.01)	4.68	4.69	(0.01)	4.77	4.77	0.00	1%	1%
11	Uttar Pradesh	6.47	5.64	0.83	6.73	5.75	0.98	7.35	6.71	0.64	4%	7%
12	Uttarakhand	4.92	4.92	0.00	5.05	5.06	(0.01)	5.28	5.32	(0.04)	4%	4%

ACoS ABR gap greater than 0	ACoS ABR gap lower than 0
-----------------------------	---------------------------

Key Observations

- While in some states like Uttar Pradesh, Gujarat and Jharkhand approved ACoS-ABR gap has been greater than 0 for the last few years, in other states (like Haryana, Odisha, Bihar, and Kerala), the gap has been lower than 0
- For states such as Karnataka, Andhra Pradesh and Uttarakhand, no ACoS-ABR gap has been approved over the years
- States such as Assam, Karnataka, Bihar and Kerala have witnessed high (>6%) annual growth in ACoS over the last 3 years

[Back](#)

State-wise rate of ROE and approved ROE

S. No.	State	DISCOMs			Intra-state transmission licensees			State GENCOs			Center GENCOs		
		FY	ROE(%)	ROE (in Rs. Crore)	FY	ROE(%)	ROE (in Rs. Crore)	FY	ROE(%)	ROE (in Rs. Crore)	FY	ROE(%)	ROE (in Rs. Crore)
1	Uttarakhand	2020-21	16.50%	115	2020-21	15.50%	39	2020-21	16%	99	2018-19	15.50%	147
2	Assam	2020-21	16.00%	26	2020-21	15.50%	15	2020-21	16%	44	2018-19	15.50%	159
3	Kerala	2020-21	14.00%	254	2020-21	14.00%	120	2020-21	14%	116	2018-19	15.50%	127
4	Bihar	2020-21	15.50%	460	2020-21	15.50%	338	2018-19	14%	245	2018-19	15.50%	273
5	Madhya Pradesh	2019-20	16.00%	787	2018-19	15.50%	388	2015-16	16%	653	2018-19	15.50%	785
6	Odisha	2020-21	16.00%	36	2019-20	15.50%	106	2019-20	16%	151	2018-19	15.50%	-
7	Karnataka	2019-20	15.50%	366	2020-21	15.50%	843	2018-19	16%	31	2018-19	15.50%	615
8	Andhra Pradesh	2020-21	13.23%	1,205	2020-21	14.00%	880	2020-21	12%	586	2018-19	15.50%	-
9	Haryana	2020-21	0.00%	-	2020-21	0.00%	-	2018-19	10%	211	2018-19	15.50%	299
10	Jharkhand	2020-21	15.50%	322	2020-21	15.50%	92	2020-21	16%	3	2018-19	15.50%	314
11	Uttar Pradesh	2019-20	16%	1,851	2020-21	2.00%	162	2018-19	16%	653	2018-19	15.50%	975
12	Gujarat	2020-21	14.00%	1,589	2020-21	14.00%	1,013	2020-21	14%	152	2018-19	15.50%	674

State-wise approved depreciation costs

S. No.	State	DISCOMs		Intra-state transmission licensees		State GENCOs		Central GENCOs	
		FY	Dep (In Rs Crores)	FY	Dep (In Rs Crores)	FY	Dep (In Rs Crores)	FY	Dep (In Rs Crores)
1	Uttarakhand	2020-21	167	2020-21	85	2020-21	167	2018-19	93
2	Assam	2020-21	24	2020-21	9	2020-21	42	2018-19	66
3	Kerala	2020-21	122	2020-21	223	2020-21	174	2018-19	34
4	Bihar	2020-21	386	2020-21	330	2018-19	299	2018-19	124
5	Madhya Pradesh	2019-20	426	2018-19	346	2016-17	797	2018-19	613
6	Odisha	2020-21	249	2019-20	162	2019-20	64	2018-19	-
7	Karnataka	2019-20	1,192	2020-21	840	2018-19	-	2018-19	513
8	Andhra Pradesh	2020-21	1,089	2020-21	623	2020-21	168	2018-19	-
9	Haryana	2020-21	651	2020-21	425	2018-19	368	2018-19	150
10	Jharkhand	2020-21	411	2020-21	266	2020-21	2	2018-19	365
11	Uttar Pradesh	2019-20	1,779	2020-21	989	2018-19	472	2018-19	524
12	Gujarat	2020-21	1,951	2020-21	1,356	2020-21	1,313	2018-19	513

Retiring Old Coal based TPPs: Gujarat

Hypothesis: Retiring of Old Power Plants may lead to significant reduction in Electricity Tariff

❑ Detailed analysis of Key Parameters (as per Norms) of Old Vs. latest Coal based Thermal Power Plants

Sl. No.	State	Sector	Owner	Name of Project	Prime Mover	Unit No.	Total Units	Installed Capacity (MW)	Year of Comm.
1	Gujarat	State Sector	GSECL	WANAKBORI TPS	Steam	1 to 6	6	1260	1982 to 1987
2	Gujarat	Private Sector	Torrent Power Ltd	SABARMATI (D-F STATIONS)	Steam	1 to 3	3	360	1978 to 1988
3	Gujarat	State Sector	GSECL	UKAI TPS	Steam	3 to 5	3	610	1979, 1985

WANAKBORI TPS - Particulars	Unit	Actual Norms, as per TO	Norms, as per TO applicable for Latest Generating Station
Installed Capacity	MW	1260	1260
Plant Load Factor (%)	%	85%	85%
Gross Generation	MU	6838.0	6838.0
Auxiliary Consumption	%	9.00%	8.00%
Net Generation	MU	6222.6	6291.0
Station Heat Rate	kCal/kWh	2625.0	2385.0
Secondary Fuel Oil Consumption	ml/kWh	1	1
Price of oil	Rs./kL	37,330	37330.0
Price of coal	Rs./MT	2,486.75	2486.8
Energy Charge Rate (Ex-bus)	Rs./kWh	1.81	1.63
Reduction in Energy Charge Rate @ (Ex-bus)		10%	

UKAI TPS - Particulars	Unit	Actual Norms, as per TO	Norms, as per TO applicable for Latest Generating Station
Installed Capacity	MW	610	610
Plant Load Factor (%)	%	85%	85%
Gross Generation	MU	3206.8	3206.8
Auxiliary Consumption	%	9.00%	8.00%
Net Generation	MU	2918.2	2950.2
Station Heat Rate	kCal/kWh	2715.0	2385.0
Price of oil	Rs./kL	33170.0	33170.0
Price of coal	Rs./MT	3645.9	3645.9
Energy Charge Rate (Ex-bus)	Rs./kWh	2.87	2.49
Reduction in Energy Charge Rate @ (Ex-bus)		13%	

SABARMATI (D-F STATIONS) - Particulars	Unit	Actual Norms, as per TO	Norms, as per TO applicable for Latest Generating Station
Installed Capacity	MW	360	360
Plant Load Factor (%)	%	87%	87%
Gross Generation	MU	2785.66	2785.66
Auxiliary Consumption	%	9.00%	8.00%
Net Generation	MU	2535.0	2562.8
Station Heat Rate	kCal/kWh	2455.0	2385.0
Secondary Fuel Oil Consumption	ml/kWh	1	1
Price of oil	Rs./kL	37,330	37330.0
Price of coal	Rs./MT	2,486.75	2486.8
Energy Charge Rate (Ex-bus)	Rs./kWh	1.51	1.45
Reduction in Energy Charge Rate @ (Ex-bus)		4%	

- ❑ There is a reduction of about 4% to 13% in Energy Charges, in case the norms for latest thermal generating station is applied to old thermal generating station which is more than 30 years old.
- ❑ As per Distribution company Tariff Order there is an Energy Surplus of ~ 13,240 MU (1500 MW approximately).
- ❑ Supply from Old Power Plants to the extent of Energy Surplus can be discontinued which leads to significant reduction in Electricity Tariff.

Retiring Old Coal based TPPs: Madhya Pradesh

Hypothesis: Retiring of Old Power Plants may lead to significant reduction in Electricity Tariff

❑ Detailed analysis of Key Parameters (as per Norms) of Old Vs. latest Coal based Thermal Power Plants

Sl. No.	State	Sector	Owner	Name of Project	Prime Mover	Unit No.	Total Units	Installed Capacity (MW)	Year of Comm.
1	Madhya Pradesh	State Sector	MPPGCL	SATPURA TPS	Steam	6 to 9	4	800	1979 to 1984
2	Madhya Pradesh	Central Sector	NTPC	VINDHYACHAL STPS*	Steam	1 to 5	5	1050	1987 to 1990

* The approved norms for Vindhyachal STPS is comparable to New Station.

SATPURA TPS - Particulars	Unit	Actual Norms, as per TO	Norms, as per TO applicable for Latest Generating Station
Installed Capacity	MW	830	830
Plant Load Factor (%)	%	85%	85%
Gross Generation	MU	6180.18	6180.18
Auxiliary Consumption	%	10.00%	6.25%
Net Generation	MU	5,562.16	5,793.92
Station Heat Rate	kCal/kWh	2700	2375
Secondary Fuel Oil Consumption	ml/kWh	1.75	0.5
Price of oil	Rs./kL	43934.0	43934.0
Price of coal	Rs./MT	3217.3	3217.3
Energy Charge Rate (Ex-bus)	Rs./kWh	2.83	2.38
Reduction in Energy Charge Rate @ (Ex-bus)		16%	

Energy Availability & Requirement						
State	FY	Energy Availability (MU)	Energy Requirement (MU)	Energy Surplus (MU)	Approx. Surplus in MW	Old Coal based TPPs (>30 Years Old), MW
Madhya Pradesh	2019-20	97,989	69,353	28,636	3,268.95	1850

- ❑ There is a reduction of about 16% in Energy Charges for Satpura thermal station, in case the norms for latest thermal generating station is applied to old thermal generating station which is more than 30 years old.
- ❑ As per Distribution company Tariff Order there is an Energy Surplus of ~ 28,000 MU or ~ 3,200 MW approximately.
- ❑ From the numbers provided in above table, it is observed that the supply from Old Power Plants can be discontinued as Surplus Power is more than the MW capacity of Old Coal based TPPs, which leads to significant reduction in Electricity Tariff.

Retiring Old Coal based TPPs: Bihar

Hypothesis: Retiring of Old Power Plants may lead to significant reduction in Electricity Tariff

❑ Detailed analysis of Key Parameters (as per Norms) of Old Vs. latest Coal based Thermal Power Plants

Sl. No.	State	Sector	Owner	Name of Project	Prime Mover	Unit No.	Total Units	Installed Capacity (MW)	Year of Comm.
1	Bihar	Central Sector	NTPC	BARAUNI TPS*	Steam	6 & 7	2	210	1983
2	Bihar	Central Sector	KBUNL	MUZAFFARPUR TPS	Steam	1 & 2	2	220	1985

MUZAFFARPUR TPS - Particulars	Unit	Actual Norms, as per TO	Norms, as per TO applicable for Latest Generating Station
Installed Capacity	MW	220	220
Plant Load Factor (%)	%	85%	85%
Gross Generation	MU	1638.12	1638.12
Auxiliary Consumption	%	12.00%	9.00%
Net Generation	MU	1,441.55	1,490.69
Station Heat Rate	kCal/kWh	3000	2430
Secondary Fuel Oil Consumption	ml/kWh	1	0.5
Price of oil	Rs./kL	78122.76	78122.76
Price of coal	Rs./MT	4,331.63	4,331.63
Energy Charge Rate (Ex-bus)	Rs./kWh	3.82	2.99
Reduction in Energy Charge Rate @ (Ex-bus)		22%	

- ❑ There is a reduction of about 22% in the Energy Charges, in case the norms for latest thermal generating station is applied to old thermal generating station which is more than 30 years old.
- ❑ There is very less gap between Energy Availability and Requirement, almost all the available Energy is utilized by the State Discom. Retiring Old coal based TPPs in Bihar will have to be replaced with new capacity.

Energy Availability & Requirement						
State	FY	Energy Availability (MU)	Energy Requirement (MU)	Energy Surplus (MU)	Approx. Surplus in MW	Old Coal based TPPs (>30 Years Old), MW
Bihar	2020-21	32,384	31,893	491	56.03	430

* Tariff Oder is not available in public domain because these two units (6 & 7) are temporarily shutdown for R&M since 2015-16.

Retiring Old Coal based TPPs: Odisha

Hypothesis: Retiring of Old Power Plants may lead to significant reduction in Electricity Tariff

❑ Detailed analysis of Key Parameters (as per Norms) of Old Vs. latest Coal based Thermal Power Plants

Sl. No.	State	Sector	Owner	Name of Project	Prime Mover	Unit No.	Total Units	Installed Capacity (MW)	Year of Comm.
1	Odisha	Central Sector	NTPC	TALCHER (OLD) TPS	Steam	1 to 6	6	460	1967 to 1983

TALCHER (OLD) TPS - Particulars	Unit	Actual Norms, as per TO	Norms, as per TO applicable for Latest Generating Station
Installed Capacity	MW	460	460
Plant Load Factor (%)	%	85%	85%
Gross Generation	MU	3425.16	3425.16
Auxiliary Consumption	%	10.50%	8.50%
Net Generation	MU	3,065.52	3,134.02
Station Heat Rate	kCal/kWh	2850	2430
Secondary Fuel Oil Consumption	ml/kWh	0.5	0.5
Price of oil	Rs./kL	52224.37	52224.37
Price of coal	Rs./MT	1,166.20	1,166.20
Energy Charge Rate (Ex-bus)	Rs./kWh	0.99	0.83
Reduction in Energy Charge Rate @ (Ex-bus)			17%

- ❑ There is a reduction of about 17% in the Energy Charges, in case the norms for latest thermal generating station is applied to old thermal generating station which is more than 30 years old.
- ❑ There is very less gap between Energy Availability and Requirement, almost all the available Energy is utilized by the State Discom. Retiring Old coal based TPPs will have to be replaced with new capacity.

Retiring Old Coal based TPPs: Uttar Pradesh

Hypothesis: Retiring of Old Power Plants may lead to significant reduction in Electricity Tariff

❑ Detailed analysis of Key Parameters (as per Norms) of Old Vs. latest Coal based Thermal Power Plants

Sl. No.	State	Sector	Owner	Name of Project	Prime Mover	Unit No.	Total Units	Installed Capacity (MW)	Year of Comm.
1	Uttar Pradesh	Central Sector	NTPC	TANDA TPS	Steam	1 to 3	3	330	1988 to 1990
2	Uttar Pradesh	Central Sector	NTPC	RIHAND STPS*	Steam	1 & 2	2	1000	1988, 1989
3	Uttar Pradesh	Central Sector	NTPC	SINGRAULI STPS	Steam	1 to 7	7	2000	1982 to 1987
4	Uttar Pradesh	State Sector	UPRVUNL	ANPARA TPS*	Steam	1 to 3	3	630	1986 to 1989
5	Uttar Pradesh	State Sector	UPRVUNL	HARDUAGANJ TPS	Steam	7	1	105	1978

* The approved norms for Rihand & Anpara TPS is comparable to New Station.

TANDA TPS - Particulars	Unit	Actual Norms, as per TO	Norms, as per TO applicable for Latest Generating Station
Installed Capacity	MW	330	330
Plant Load Factor (%)	%	85%	85%
Gross Generation	MU	2457.18	2457.18
Auxiliary Consumption	%	12.00%	8.50%
Net Generation	MU	2,162.32	2,248.32
Station Heat Rate	kCal/kWh	2750	2430
Secondary Fuel Oil Consumption	ml/kWh	0.5	0.5
Price of oil	Rs./kL	58248.61	58248.61
Price of coal	Rs./MT	4,035.21	4,035.21
Energy Charge Rate (Ex-bus)	Rs./kWh	2.37	2.01
Reduction in Energy Charge Rate @ (Ex-bus)		15%	

HARDUAGANJ TPS (6 & 7) - Particulars	Unit	Actual Norms, as per TO	Norms, as per TO applicable for Latest Generating Station
Installed Capacity	MW	165	165
Plant Load Factor (%)	%	65%	85%
Gross Generation	MU	939.51	1228.59
Auxiliary Consumption	%	11.00%	9.00%
Net Generation	MU	836.16	1,118.02
Station Heat Rate	kCal/kWh	3150	2475
Secondary Fuel Oil Consumption	ml/kWh	3.7	3.7
Price of oil	Rs./kL	33,122.60	33,122.60
Price of coal	Rs./MT	4,705.49	4,705.49
Energy Charge Rate (Ex-bus)	Rs./kWh	3.86	2.97
Reduction in Energy Charge Rate @ (Ex-bus)		23%	

SINGRAULI STPS - Particulars	Unit	Actual Norms, as per TO	Norms, as per TO applicable for Latest Generating Station
Installed Capacity	MW	2000	2000
Plant Load Factor (%)	%	85%	85%
Gross Generation	MU	14892	14892
Auxiliary Consumption	%	6.88%	5.75%
Net Generation	MU	13,867.43	14,035.71
Station Heat Rate	kCal/kWh	2412.5	2226.09
Secondary Fuel Oil Consumption	ml/kWh	0.5	0.5
Price of oil	Rs./kL	48,311.61	48,311.61
Price of coal	Rs./MT	1,564.66	1,564.66
Energy Charge Rate (Ex-bus)	Rs./kWh	0.88	0.80
Reduction in Energy Charge Rate @ (Ex-bus)		15%	

- ❑ There is a reduction of up to 23% in Energy Charges, in case the norms for latest thermal generating station is applied to old thermal generating station which is more than 30 years old.
- ❑ In case of Uttar Pradesh the surplus energy is only 2.2% of total Energy Requirement but the capacity of Old coal based TPPs are much higher. Retiring Old coal based TPPs will have to be replaced with new capacity

[Back](#)

Merit Order Dispatch (MOD): Issues & Guidelines (1/3)

	IDENTIFIED ISSUES	GUIDELINES
1.	Guidelines for Zero Schedule instructions to the Generating Units	<ul style="list-style-type: none">• In case of anticipated generation availability in surplus, the Distribution Licensee (DL) needs to optimize their cost of power procurement considering the contracted sources for the period of anticipated surplus,• DL may consider giving Zero Schedule to some of its contracted sources. This should be a conscious decision of the DL in consultation with Maharashtra State Load Despatch Centre (MSLDC) taking into account the demand supply position and transmission constraints.• If grid constraints prevent the Zero Scheduling of the unit with highest Variable Charge (VC) in the MOD stack, the unit with the next highest VC needs to be considered.• The DL must give the Generating Company 24 hours prior notice of the Zero Scheduling.• In case a particular unit is, in fact, required to be scheduled during the pre-declared Zero Scheduling period, the DL must intimate the Generating station at least 72 hours in advance for the Unit(s) to come on bar in cold start.• Zero Scheduling to be carried out by DL considering the roles and obligations under the corresponding PPAs• Additional cost implication in Variable Charges that arises on account of Zero Scheduling will not be allowed as pass through

Merit Order Dispatch (MOD): Issues & Guidelines (1/3)

	IDENTIFIED ISSUES	GUIDELINES
2.	Guidelines for Reserve Shut Down (RSD) of Generating Units by MSDLC	<ul style="list-style-type: none"> • A Reserve Margin equivalent to the contracted capacity of the largest unit of the Power Station, contracted by the Distribution Licensee needs to maintained. • The Reserve Shut Down (RSD) should be implemented for the capacity available in excess of the largest Unit contracted by the DL. • The RSD should be applied to Units with higher Variable Charges in the MOD stack, subject to grid conditions permitting the same.
3.	Periodicity and date of preparation of MOD stack	<ul style="list-style-type: none"> • Variable Charge of immediately preceding month and in case the Variable Charge (VC) of immediately month is no available, the average of the latest available VC for the preceding 3 months needs considered for preparation of the MOD stack. • SLDC to prepare the MOD stack by 15th of every month which will be effective from 16th of the month till 15th of subsequent month • The MOD Stack may be subsequently revised by MSLDC-OD on account of new source, revision in Variable Charges due to issuance of Tariff Order by CERC or SERC and impact of change in Law as per PPA
4.	Basis of preparation of MOD stack, including the variable charge to be considered	<ul style="list-style-type: none"> • DL need to submit data for variable charges of generating stations/units to MSLDC. • For Generating Stations (GS) whose tariff is being determined by the Commission under sec 62, the VC for MOD purposes shall be the Energy Charge plus the actual FSA. • For Central GS , the VC for MOD purposes shall be the landed cost at the State Periphery. • For PPAs entered under sec 63, the VC for MOD purposes shall be the Energy Charge plus impact of change in law. • For Intra State OA transactions above 50 MW, 60% of total tariff shall be considered as VC for MOD purpose.

Merit Order Dispatch (MOD): Issues & Guidelines (3/3)

	IDENTIFIED ISSUES	GUIDELINES
5.	Guidelines for operating the Generating Units	<ul style="list-style-type: none"> As a basic principle, MSLDC is required to finalize the despatch schedule based on least-cost principles. DL should try to procure the highest possible capacity from the units permitted by the system, rather than scheduling the Units at Technical Minimum.
6.	Guidelines for capacity declaration by Generating units	<ul style="list-style-type: none"> Apart from the day ahead generation schedule, the Generating Company shall also provide the additional information regarding the fuel and water availability in the provided format. In accordance with the MERC MYT Regulations 2015 provision which specifies the demonstration of Declared capacity by GS, MSLDC shall ask the GS to demonstrate the max DC of Generating unit for the particular time block.
7.	Identification of Must Run Stations, and guidelines for operating Hydro Stations	<ul style="list-style-type: none"> With significant generation capacity addition in the State, MSLDC needs to ensure that the intended purpose of Hydro Generating Stations is not defeated and indiscriminate use of Hydro power is avoided.
8.	Technical Minimum of Generating Units	<ul style="list-style-type: none"> Technical Minimum for operation in respect of a coal fired/gas fired/multi fuel based thermal generating unit connected to the STU shall be 55% of its installed capacity.

CERC Staff Paper on FGD

Norms for Consumption of Reagent (1/2)

The normative consumption of specific reagent for various technologies for reduction of emission of sulphur dioxide shall be as below:

(a) For Wet Limestone based Flue Gas De-sulphurisation (FGD) system

The specific limestone consumption (g/kWh) shall be worked out by following formula:

$$[0.85 \times K \times \text{SHR (kCal/kWh)} \times \text{S (\%)}] \times [\text{GCV (kCal/kg)} \times \text{LP (\%)}]$$

Where,

S = Sulphur content in percentage,

LP = Limestone Purity in percentage,

Provided that value of K shall be equivalent to $(35.2 \times \text{Design SO}_2 \text{ Removal Efficiency}/96\%)$ for units to comply with SO₂ emission norm of 100/200 mg/Nm³ or $(26.8 \times \text{Design SO}_2 \text{ Removal Efficiency}/73\%)$ for units to comply with SO₂ emission norm of 600 mg/Nm³;

Provided further that the limestone purity shall not be less than 85%.

CERC Staff Paper on FGD

Norms for Consumption of Reagent (2/2)

(b) For Lime Spray Dryer or Semi-dry Flue Gas Desulphurisation (FGD) system

The specific lime consumption shall be worked out based on minimum purity of lime (LP) as at 90% or more by applying formula $[6 \times 0.90 / PL (\%)]$ gm/kWh

(c) For Dry Sorbent Injection System (using sodium bicarbonate)

The specific consumption of sodium bicarbonate shall be 12 g per kWh at 100% purity

(d) For CFBC Technology (furnace injection) based generating station

The specific limestone consumption for CFBC based generating station (furnace injection) shall be computed with the following formula:

$[62.9 \times S(\%) \times SHR \text{ (kCal/kWh)} / GCV \text{ (kCal/kg)}] \times [0.85/ LP]$, Where

S = Sulphur content in percentage,

LP = Limestone Purity in percentage

(e) For Sea Water based Flue Gas Desulphurisation (FGD) system

The reagent used is sea water, therefore there is no requirement for any normative formulae for consumption of reagent.

Inter & Intra-State Transmission Charges (Rs. Crore & Rs./kWh)

Change in Transmission Cost over the last 4 years

Madhya Pradesh: Transmission Charges (Rs. Crore)

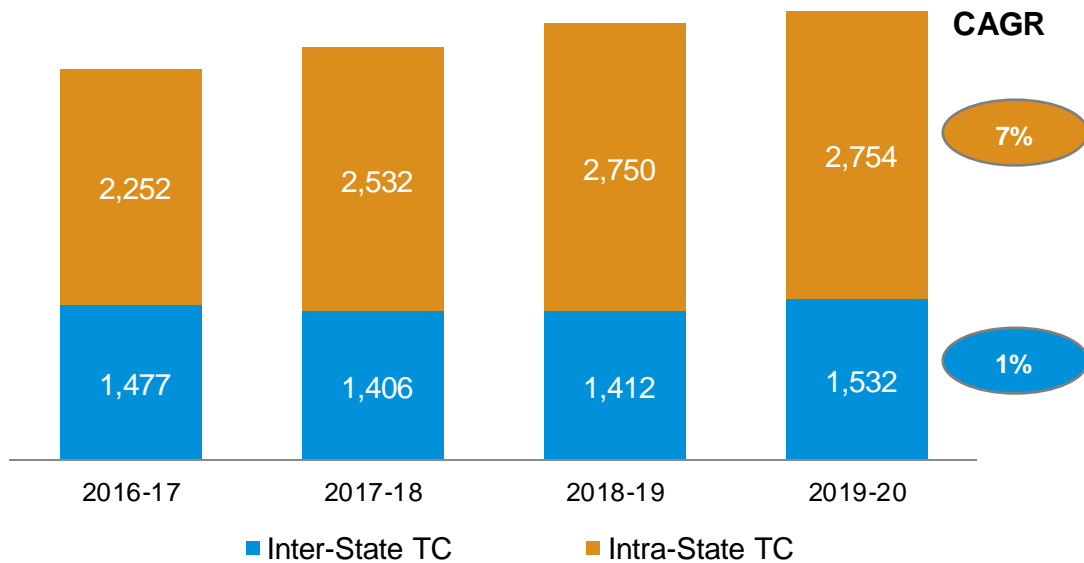

The share of intra-state transmission charges has increased in last 4 years whereas the share of inter-state transmission charges remain constant.

Madhya Pradesh: Transmission Charges* (Rs./kWh)

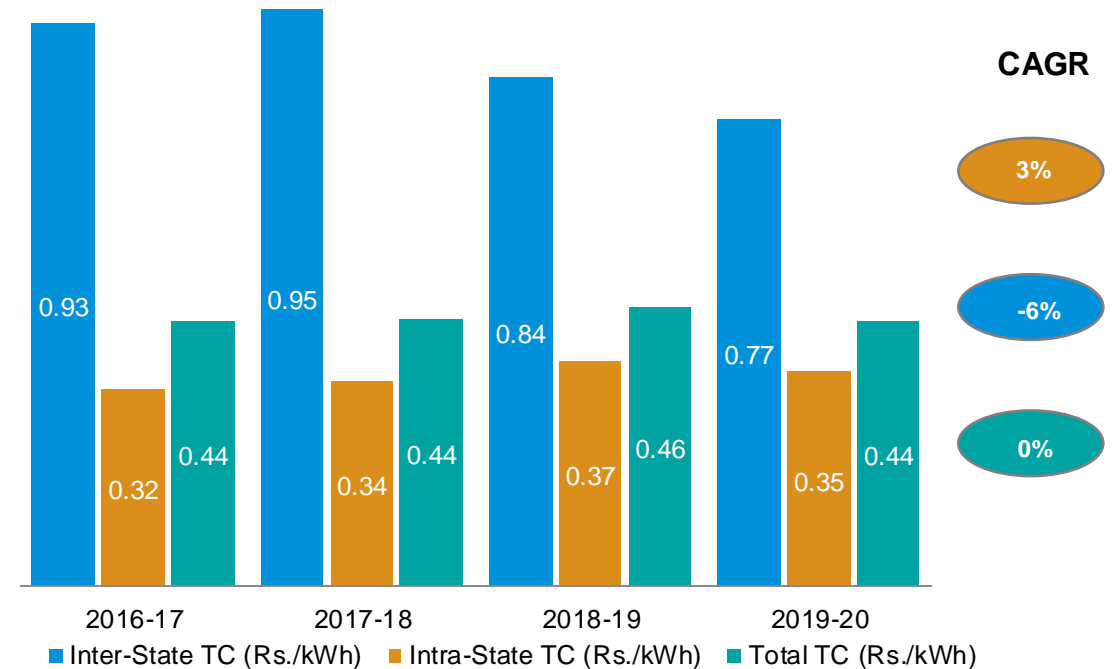

Per unit inter-state TC has reduced over the last 4 years whereas the per unit intra-state TC has increased

Source: Tariff orders issued by respective state commissions for the last 4 years;

*Inter-state TC per unit is computed based on energy procured from ISGS and intra-state TC per unit is computed based on power procured from plants within the state

Inter & Intra-State Transmission Charges (Rs. Crore & Rs./kWh)

Change in Transmission Cost over the last 4 years

Uttarakhand: Transmission Charges (Rs. Crore)

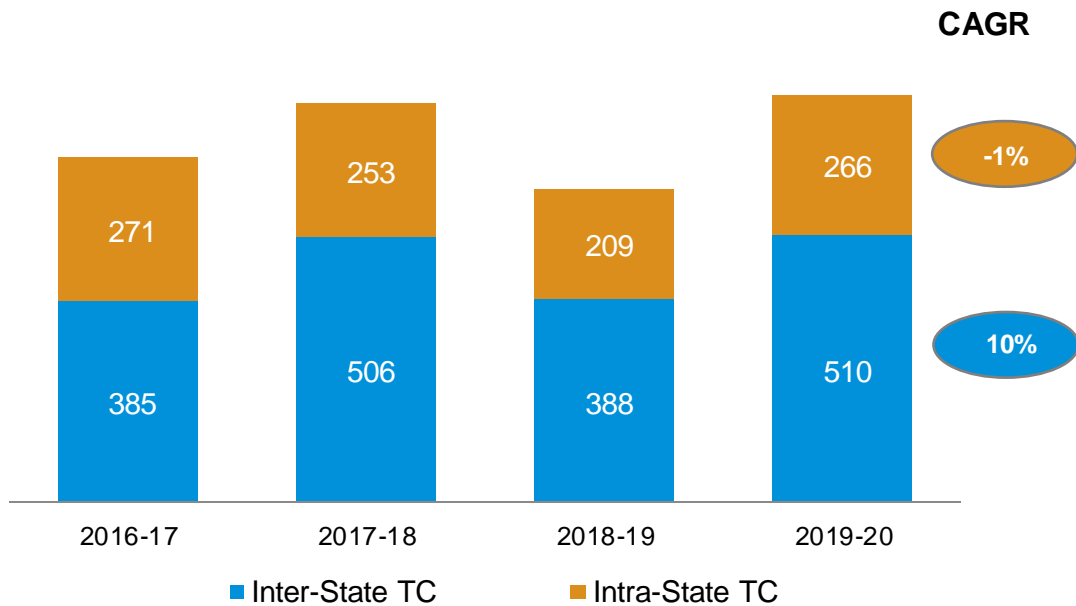

The share of inter-state transmission charges has increased in last 4 years whereas the share of intra-state transmission charges remain constant.

Uttarakhand: Transmission Charges* (Rs./kWh)

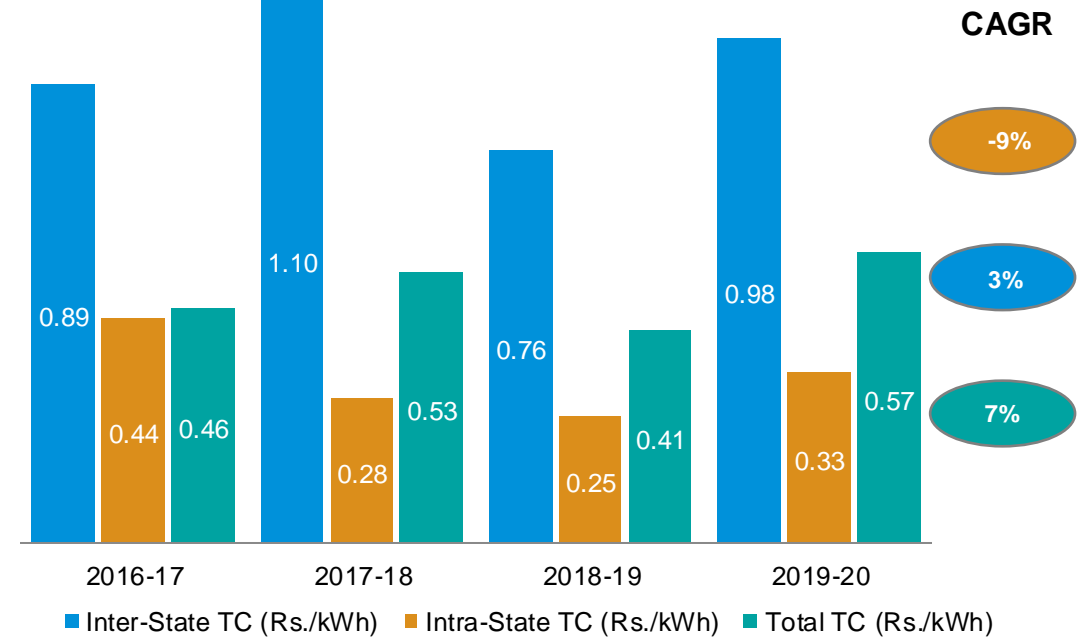

Per unit inter-state TC has increased over the last 4 years whereas the per unit intra-state TC has reduced.

Source: Tariff orders issued by respective state commissions for the last 4 years;

*Inter-state TC per unit is computed based on energy procured from ISGS and intra-state TC per unit is computed based on power procured from plants within the state

Inter & Intra-State Transmission Charges (Rs. Crore & Rs./kWh)

Change in Transmission Cost over the last 4 years

Karnataka: Transmission Charges (Rs. Crore)

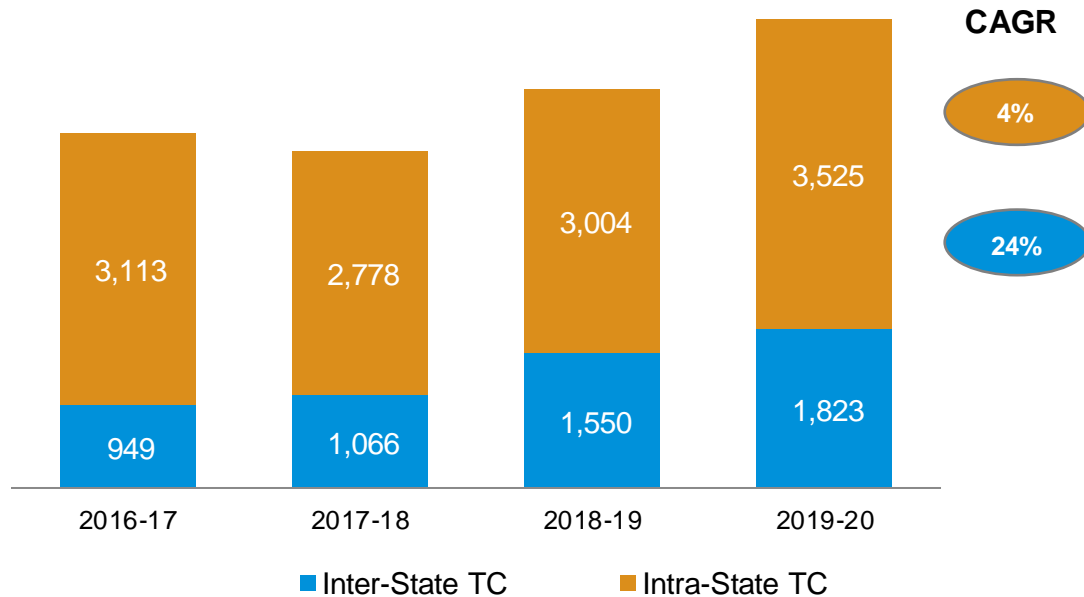

The share of Inter-State transmission charges has increased @ 24% CAGR in last 4 years whereas the share of Intra-State transmission charges has increased @ 4% CAGR only.

Karnataka: Transmission Charges* (Rs./kWh)

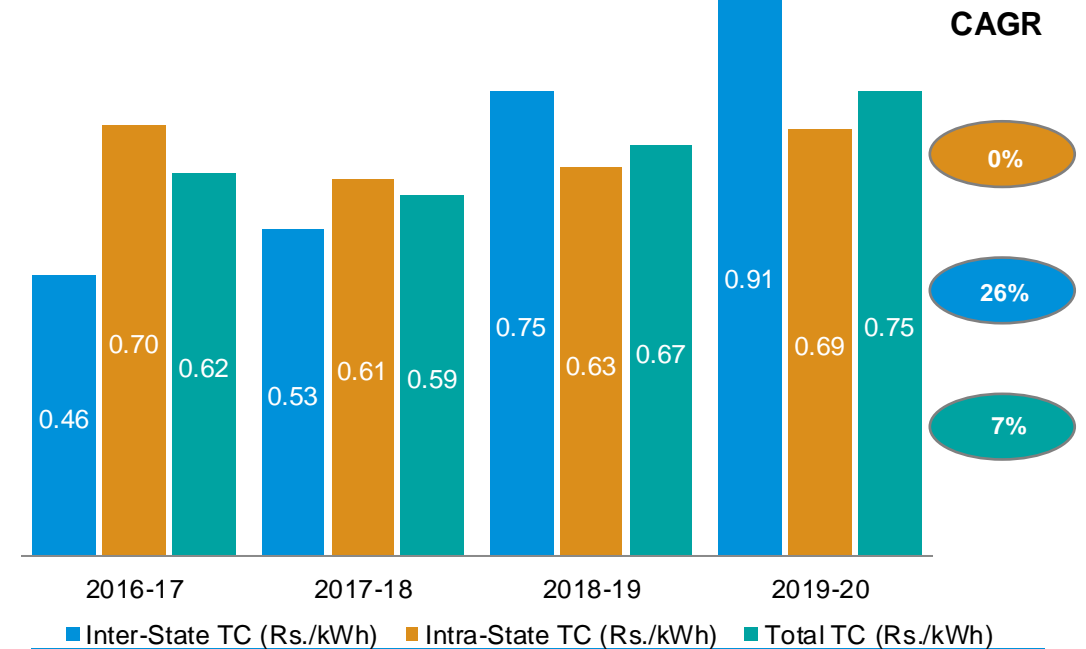

Per unit inter-state TC has increased significantly over the last 4 years whereas the per unit intra-state TC has remained the same

Source: Tariff orders issued by respective state commissions for the last 4 years;

*Inter-state TC per unit is computed based on energy procured from ISGS and intra-state TC per unit is computed based on power procured from plants within the state

Inter & Intra-State Transmission Charges (Rs. Crore & Rs./kWh)

Change in Transmission Cost over the last 4 years

Kerala : Transmission Charges (Rs. Crore)

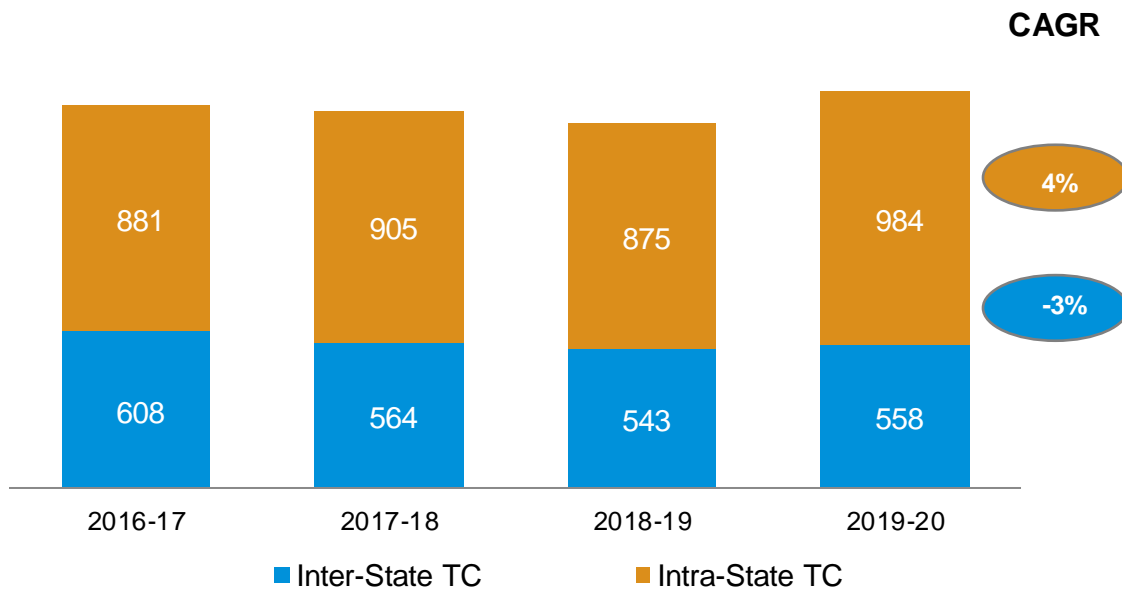

The share of intra-state transmission charges has decreased in last 4 years whereas the share of inter-state transmission charges has increased.

Kerala: Transmission Charges* (Rs./kWh)

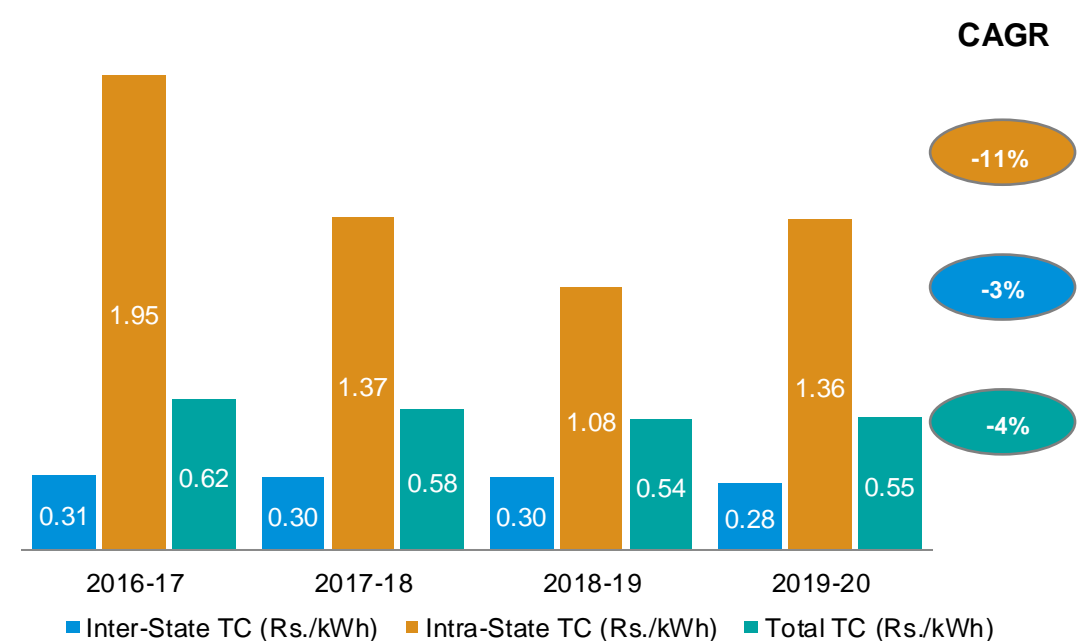

Per unit inter-state TC has decreased over the last 4 years whereas the per unit intra-state TC has reduced at a higher rate

Source: Tariff orders issued by respective state commissions for the last 4 years;

*Inter-state TC per unit is computed based on energy procured from ISGS and intra-state TC per unit is computed based on power procured from plants within the state

Inter & Intra-State Transmission Charges (Rs. Crore & Rs./kWh)

Change in Transmission Cost over the last 4 years

Jharkhand: Transmission Charges (Rs. Crore)

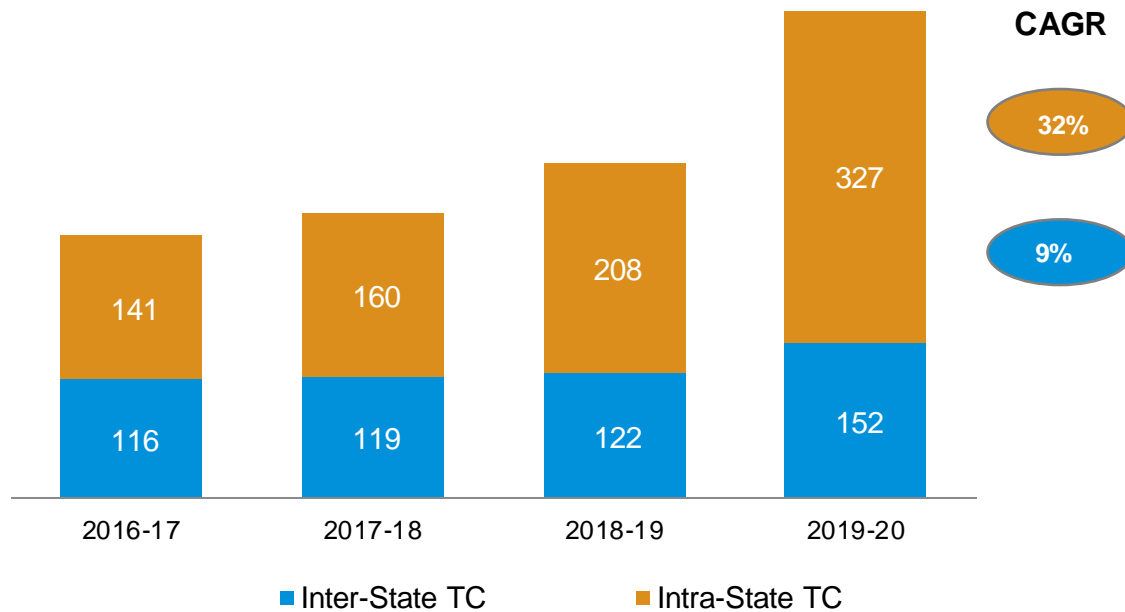

The share of Intra-state transmission charges has increased @ 32% CAGR in last 4 years whereas the share of inter-state transmission charges has increased @ 9% CAGR only.

Jharkhand: Transmission Charges (Rs./kWh)

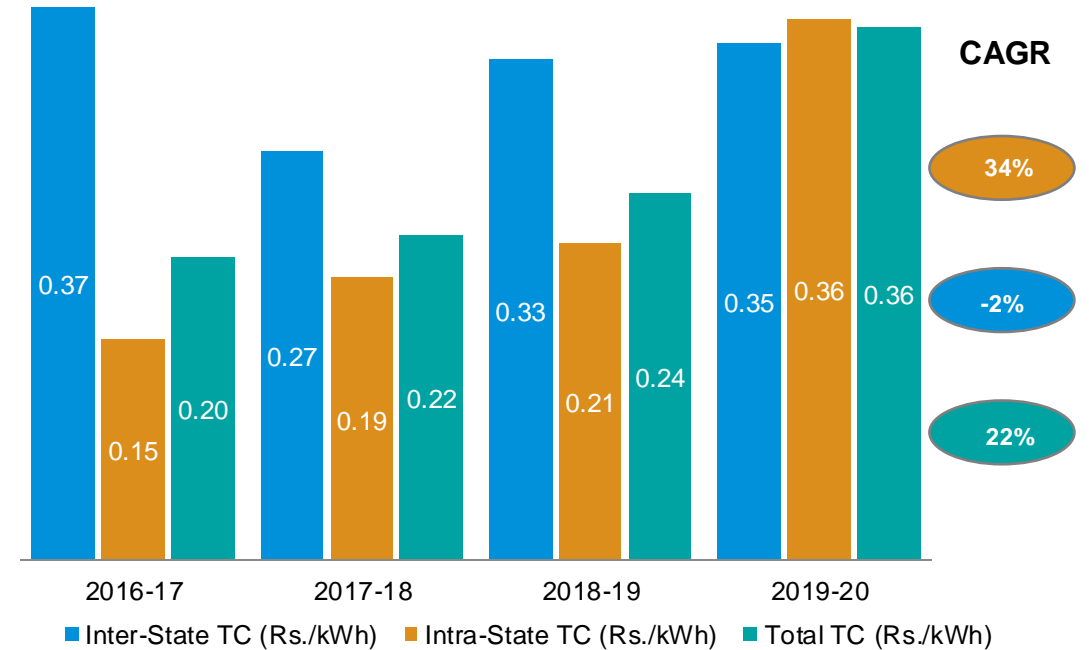

Per unit inter-state TC has decreased marginally over the last 4 years whereas per unit intra-state TC has increased significantly

Source: Tariff orders issued by respective state commissions for the last 4 years;

*Inter-state TC per unit is computed based on energy procured from ISGS and intra-state TC per unit is computed based on power procured from plants within the state

Inter & Intra-State Transmission Charges (Rs. Crore & Rs./kWh)

Change in Transmission Cost over the last 4 years

Odisha: Transmission Charges (Rs. Crore)

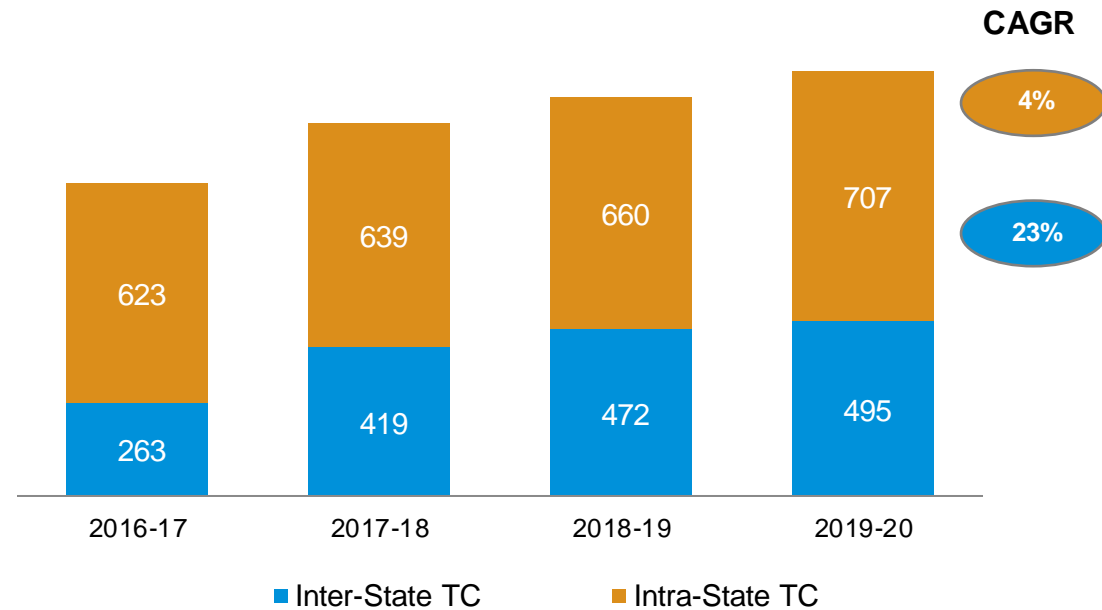

The share of inter-state transmission charges has increased @ 23% CAGR in last 4 years whereas the share of intra-state transmission charges has increased @ 4% CAGR only.

Odisha: Transmission Charges (Rs./kWh)

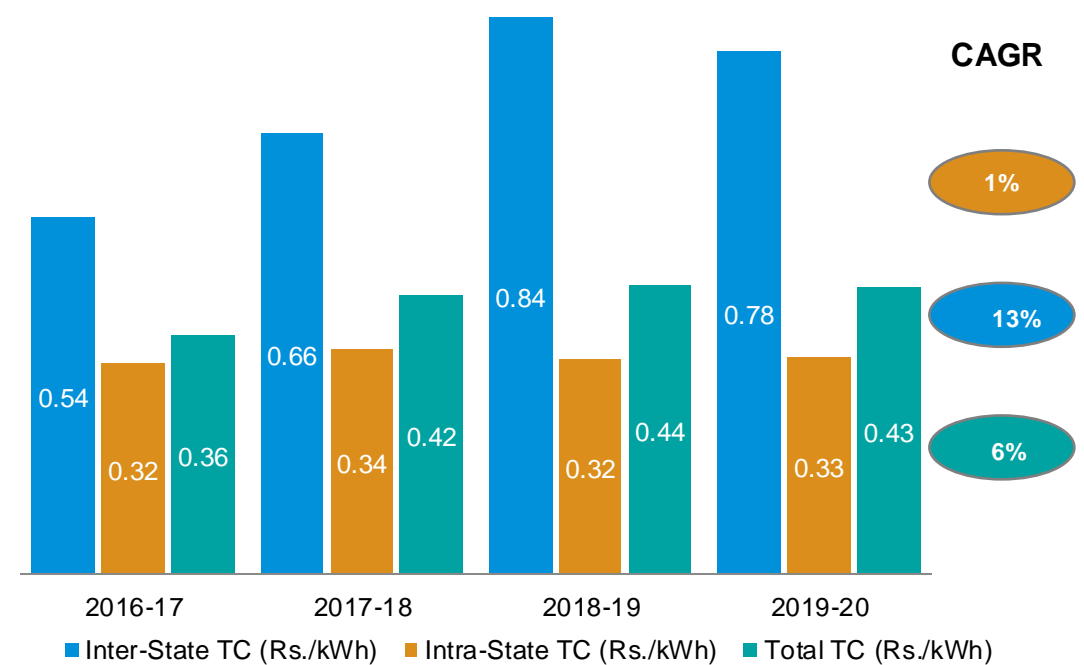

Per unit inter-state TC has increased over the last 4 years whereas per unit intra-state TC has increased marginally

Source: Tariff orders issued by respective state commissions for the last 4 years;

*Inter-state TC per unit is computed based on energy procured from ISGS and intra-state TC per unit is computed based on power procured from plants within the state

Inter & Intra-State Transmission Charges (Rs. Crore & Rs./kWh)

Change in Transmission Cost over the last 4 years

Assam: Transmission Charges (Rs. Crore)

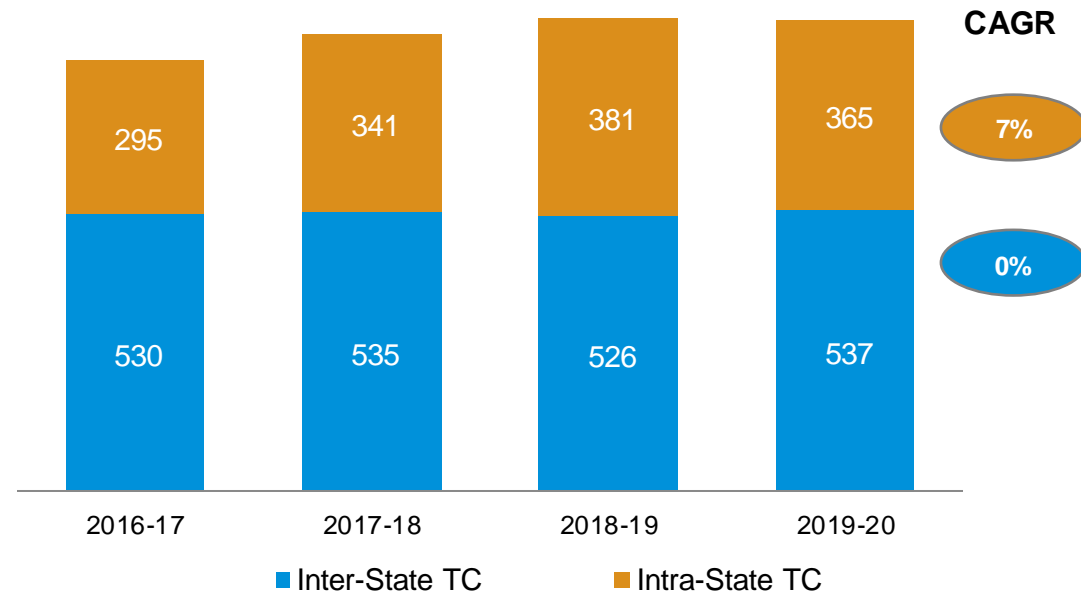

The share of intra-state transmission charges has increased in last 4 years whereas the share of inter-state transmission charges remain constant.

Assam: Transmission Charges (Rs./kWh)

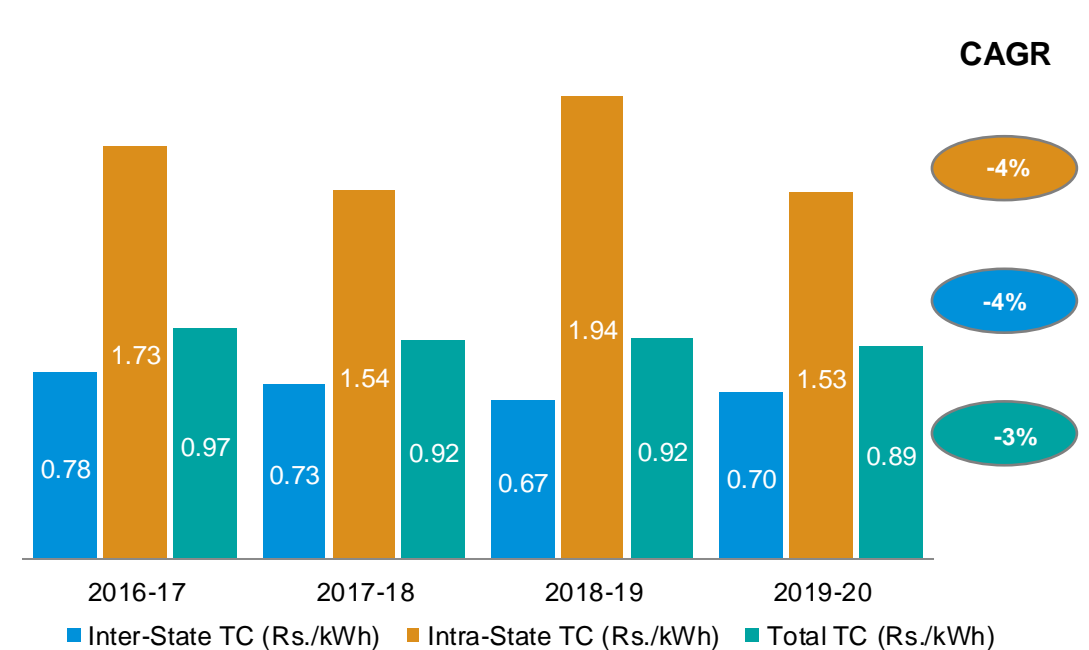

Per unit intra-state TC per unit and per unit inter-state TC has decreased over the last 4 years

Source: Tariff orders issued by respective state commissions for the last 4 years;

*Inter-state TC per unit is computed based on energy procured from ISGS and intra-state TC per unit is computed based on power procured from plants within the state

Inter & Intra-State Transmission Charges (Rs. Crore & Rs./kWh)

Change in Transmission Cost over the last 4 years

Bihar: Transmission Charges (Rs. Crore)

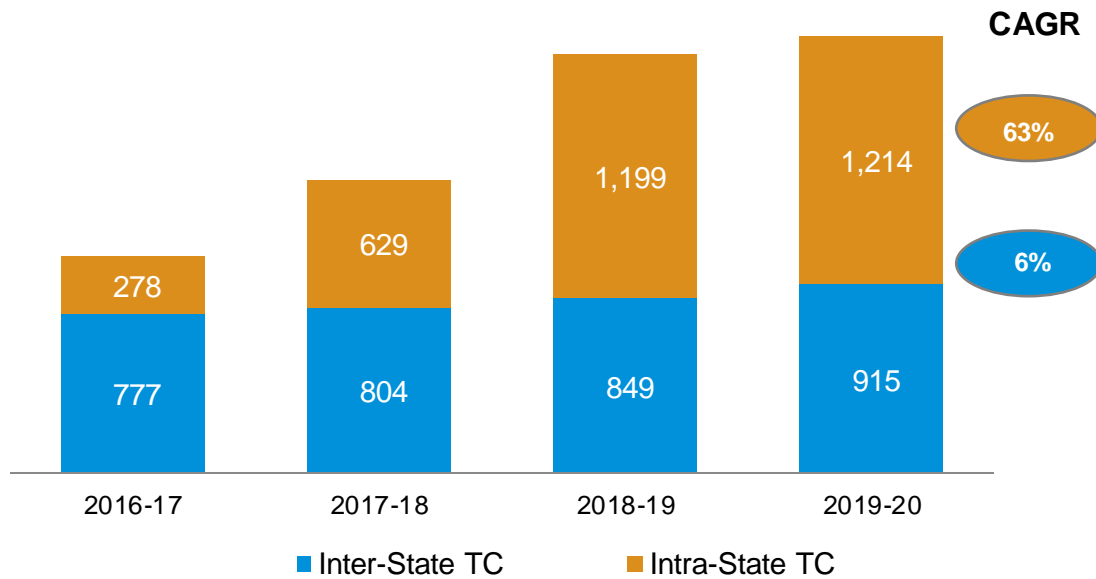

The share of intra-state transmission charges has increased at much higher rate in comparison to inter-state transmission charges in last 4 years.

Bihar: Transmission Charges (Rs./kWh)

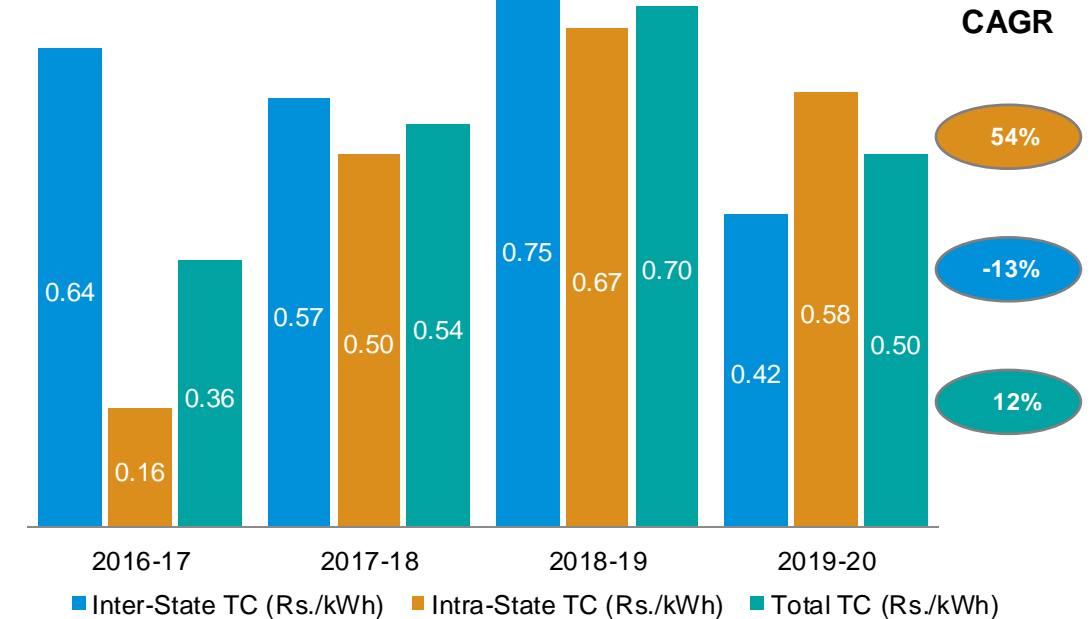

Per unit inter-state TC has decreased over the last 4 years whereas the per unit intra-state TC has increased significantly

Source: Tariff orders issued by respective state commissions for the last 4 years;

*Inter-state TC per unit is computed based on energy procured from ISGS and intra-state TC per unit is computed based on power procured from plants within the state

Inter & Intra-State Transmission Charges (Rs. Crore & Rs./kWh)

Change in Transmission Cost over the last 4 years

Haryana: Transmission Charges (Rs. Crore)

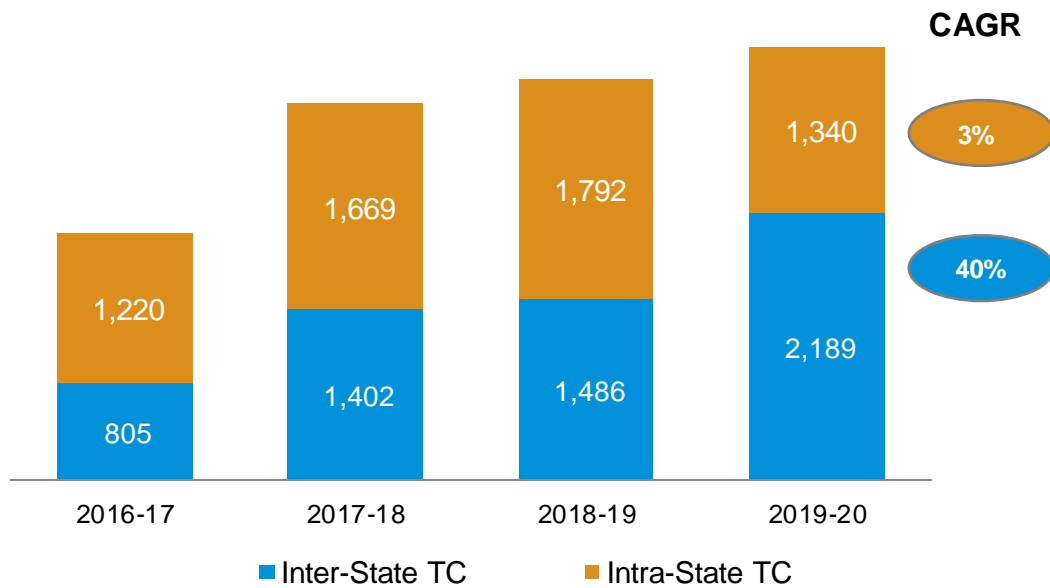

The share of inter-state transmission charges has increased at much higher rate in comparison to intra-state transmission charges in last 4 years,

Haryana: Transmission Charges (Rs./kWh)

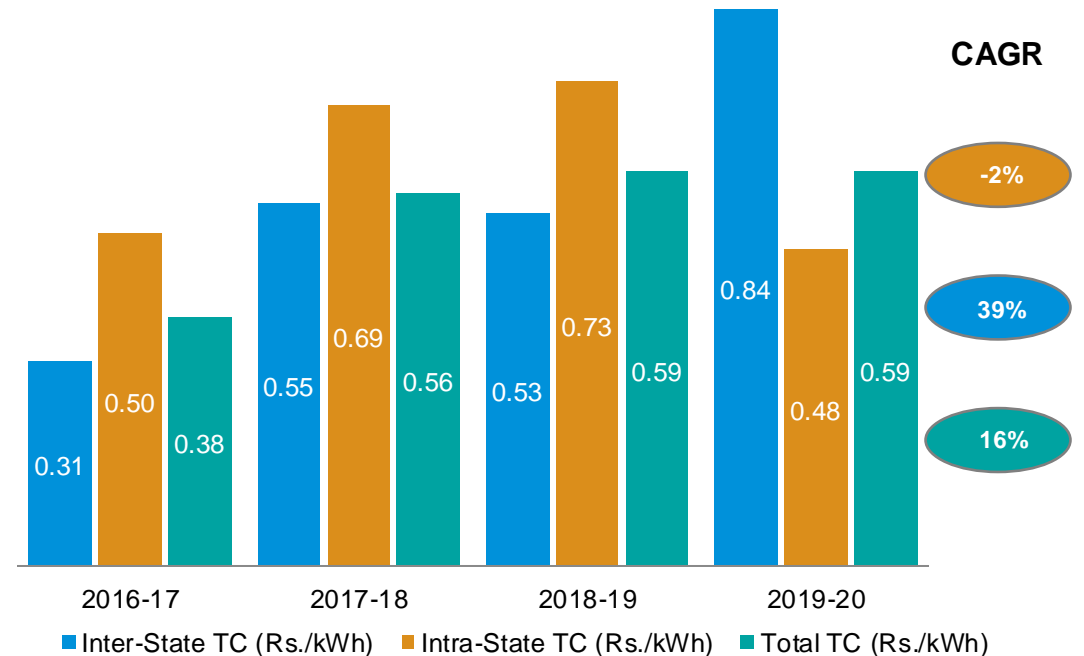

Per unit inter state TC has increased significantly over the last 4 years whereas the per unit intra-state TC has decreased marginally

Source: Tariff orders issued by respective state commissions for the last 4 years;

*Inter-state TC per unit is computed based on energy procured from ISGS and intra-state TC per unit is computed based on power procured from plants within the state

Inter & Intra-State Transmission Charges (Rs. Crore & Rs./kWh)

Change in Transmission Cost over the last 4 years

Uttar Pradesh: Transmission Charges (Rs. Crore)

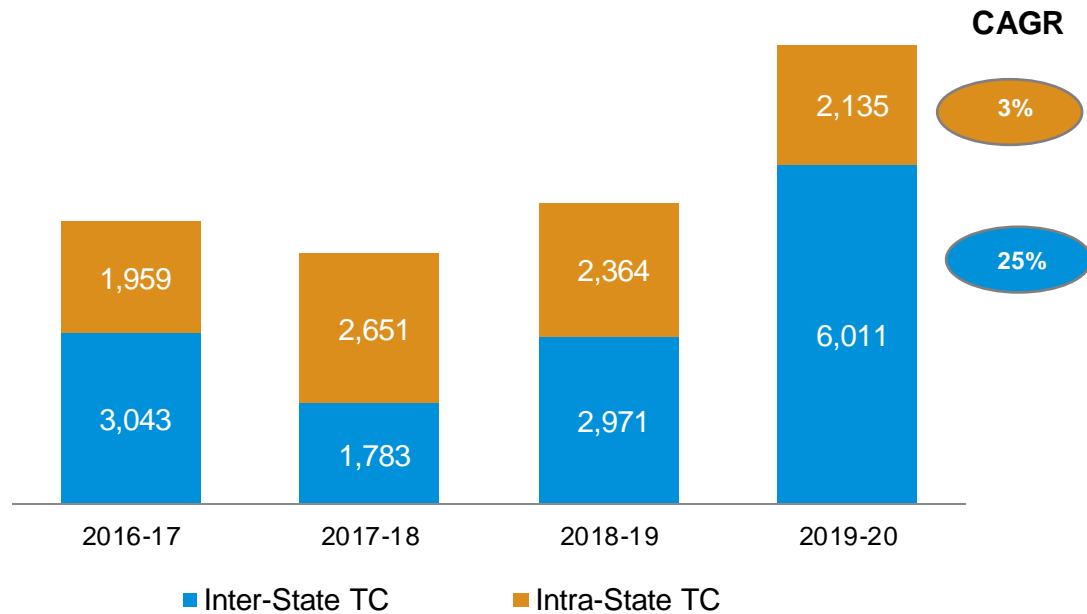

The share of intra-state transmission charges has remains constant in last 4 years, but inter-state transmission charges increased by 25% in last 4 years.

Uttar Pradesh: Transmission Charges (Rs./kWh)

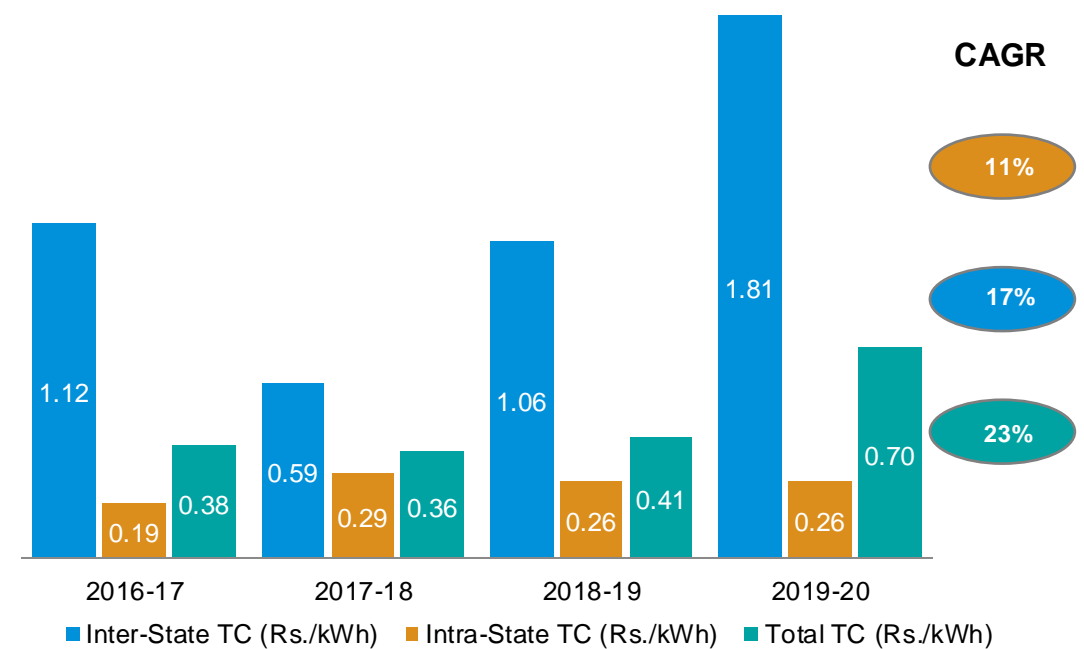

Per unit inter-state TC has increased over the last 4 years whereas the per unit intra-state TC has increased at a lower rate

Source: Tariff orders issued by respective state commissions for the last 4 years;

*Inter-state TC per unit is computed based on energy procured from ISGS and intra-state TC per unit is computed based on power procured from plants within the state

Inter & Intra-State Transmission Charges (Rs. Crore & Rs./kWh)

Change in Transmission Cost over the last 4 years

Andhra Pradesh: Transmission Charges (Rs. Crore)

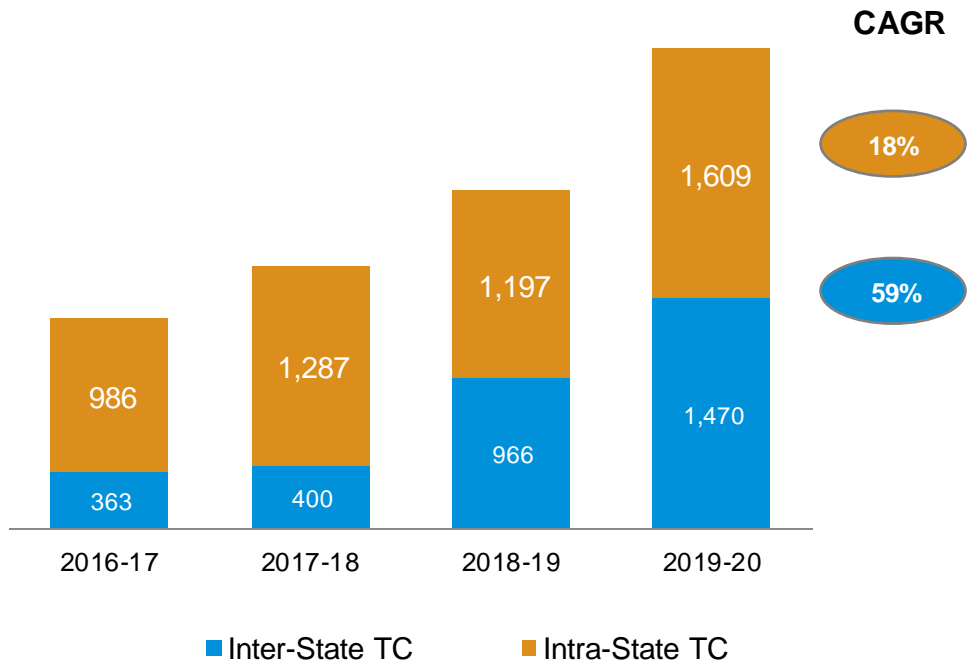

The share of inter-state transmission charges has increased at much higher rate in comparison to intra-state transmission charges in last 4 years,

Andhra Pradesh: Transmission Charges (Rs./kWh)

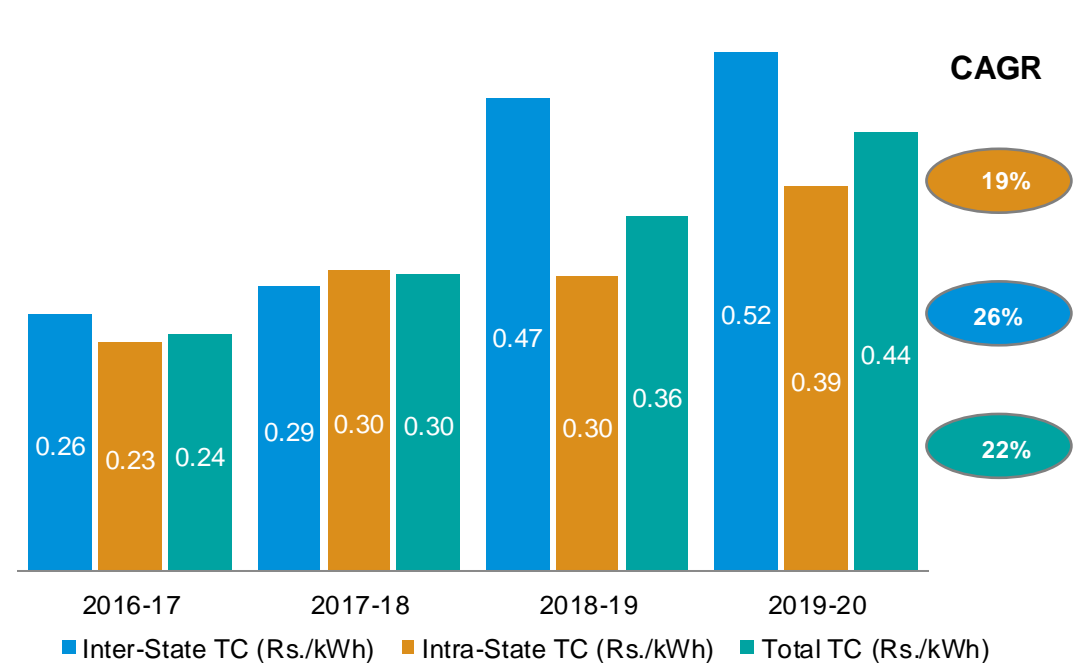

Per unit inter state TC has increased significantly over the last 4 years whereas the per unit intra-state TC has increased at a lower rate

Source: Tariff orders issued by respective state commissions for the last 4 years;

*Inter-state TC per unit is computed based on energy procured from ISGS and intra-state TC per unit is computed based on power procured from plants within the state

Inter & Intra-State Transmission Charges (Rs. Crore & Rs./kWh)

Change in Transmission Cost over the last 4 years

Gujarat: Transmission Charges (Rs. Crore)

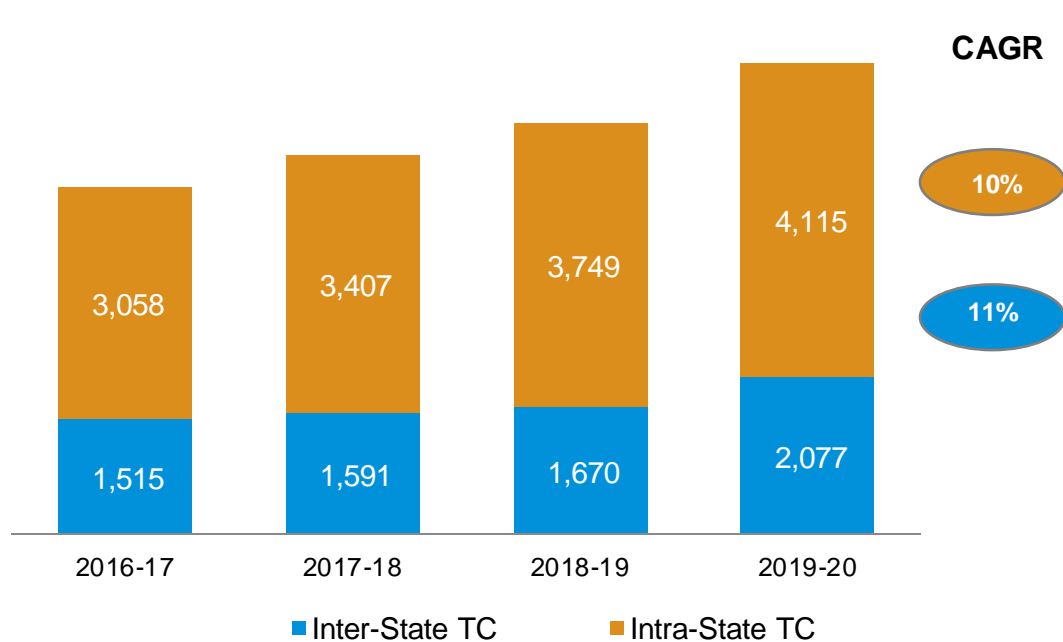

The share of intra & inter-state transmission charges has increased @ ~10% CAGR in last 4 years.

Gujarat: Transmission Charges (Rs./kWh)

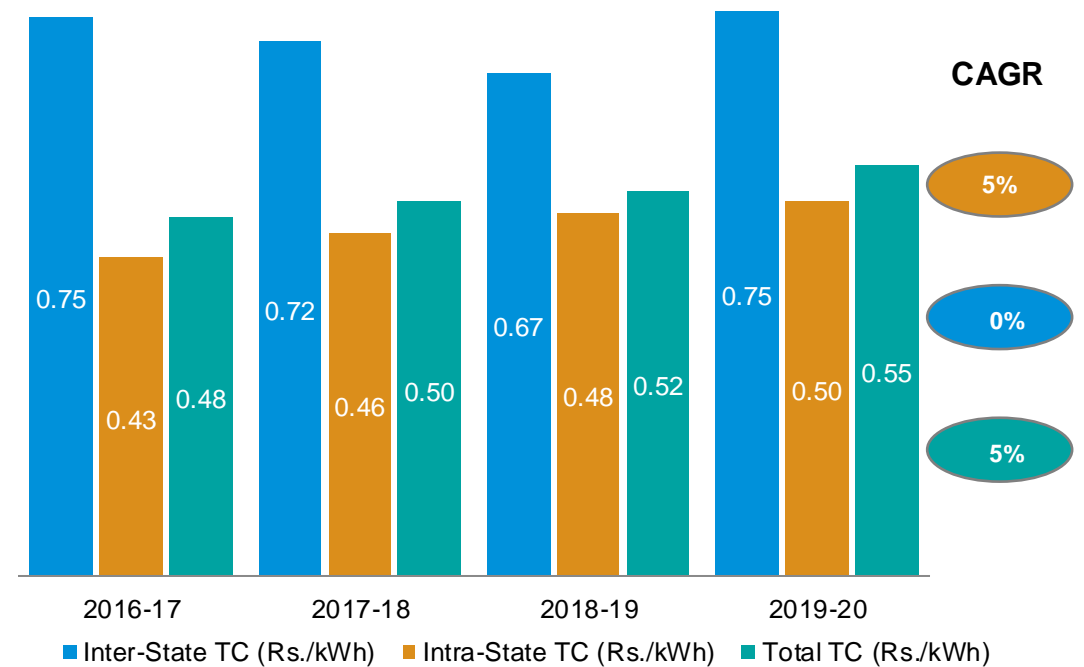

Per unit inter state TC has remained constant over the last 4 years whereas the per unit intra-state TC has increased

Source: Tariff orders issued by respective state commissions for the last 4 years;

*Inter-state TC per unit is computed based on energy procured from ISGS and intra-state TC per unit is computed based on power procured from plants within the state



EFFECT OF CAPACITORS

IN AGRICULTURE SEGMENT IN REDUCTION

OF TECHNICAL LOSS

BY WAY OF

VAR COMPENSATION

Presented by
Chairman/TNERC

The energy Conservation Act 2001

India is the second country in the world next to USA to enact an ACT called '**The energy Conservation Act 2001**'.

A lot of electrical energy can be conserved by improving the efficiency of the electrical system. One of the methods is the reactive power management.

The core objective of all power reforms schemes like, RAPDRP, IPDS, UDAY etc., is to reduce the AT&C loss in the network.

Reactive power management



At present the power factor correction is internationally termed as the **reactive power management**.

An induction motor draws power from a far off generating station. This power consists of two components, one is the active power (kW) and the other one is the reactive power (kVAr – or simply var). When the two powers are added the power obtained is the apparent power (kVA). This apparent power (kVA) is to be delivered by the generating station. -contd..

Thus the generated apparent power is factorized into two powers as above by a factor called power factor.

The active power (kW) is to do the actual work, the other one the reactive power (kVAr) is to meet the magnetizing requirement of the inductive circuit of the induction motor.

The reactive power is just necessary to put the motor into action on the principle of electromagnetic induction but **never spent** by the motor and this reactive power returns to the generating station after a few milliseconds in a cycle of 20 millisecond. -contd..

During the next cycle this power is again required by the motor and drawn from the far away generating station.

The reactive power flow from the generating station to the motor and then returned to the generating station is repeated for every cycle of the system frequency of 50 cycles per second.

This is called magnetic reversal and responsible for bringing down the efficiency of the system as a whole.

The reduction of reactive power drawn from the generating station is called the reactive power management.

Role of capacitor in reducing the reactive power drawn from generating station:

When a capacitor is connected across a motor, the power returned to the generating station by the motor during magnetic reversal is made use of charging the capacitor instead of flowing to the generating station.

During the next cycle, the reactive power required by the motor will be supplied by the capacitor itself by discharging, instead of drawing the reactive power from the generating station.

The reactive power flow between the generating station and the motor is thus reduced.

The maximum benefit could be achieved if the capacitors are connected across the motor/ load.



WORKING PRINCIPLE OF CAPACITOR

BEFORE INSTALLING

CAPACITOR

Supply Bus

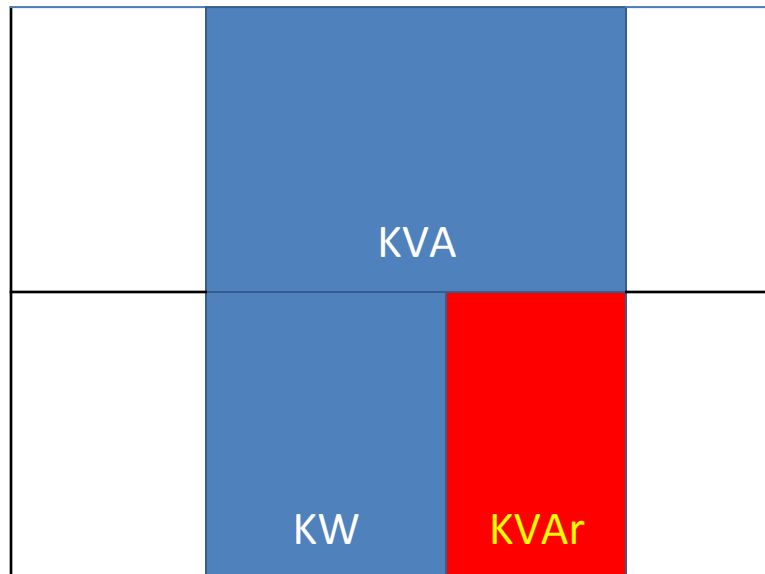

Input = **KVA - 10** Output =

KW - 9 Power Factor =

9/10 = 0.9

Efficiency = **90%**

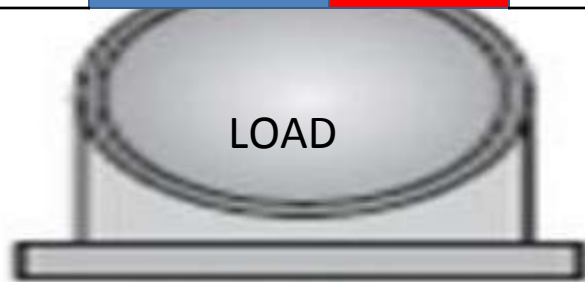

Motor

AFTER INSTALLING

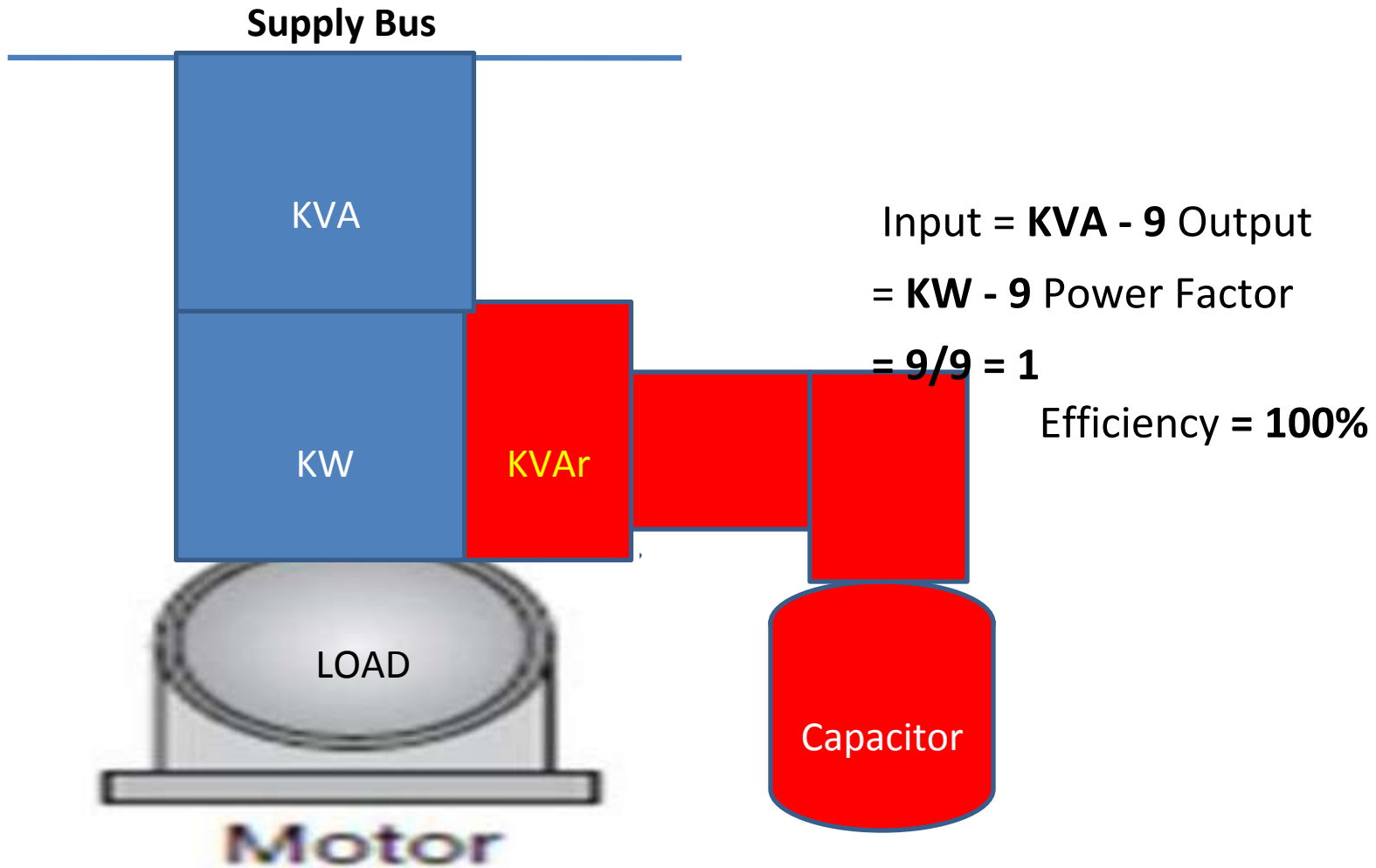

When No Capacitors are Connected in Electrical Network

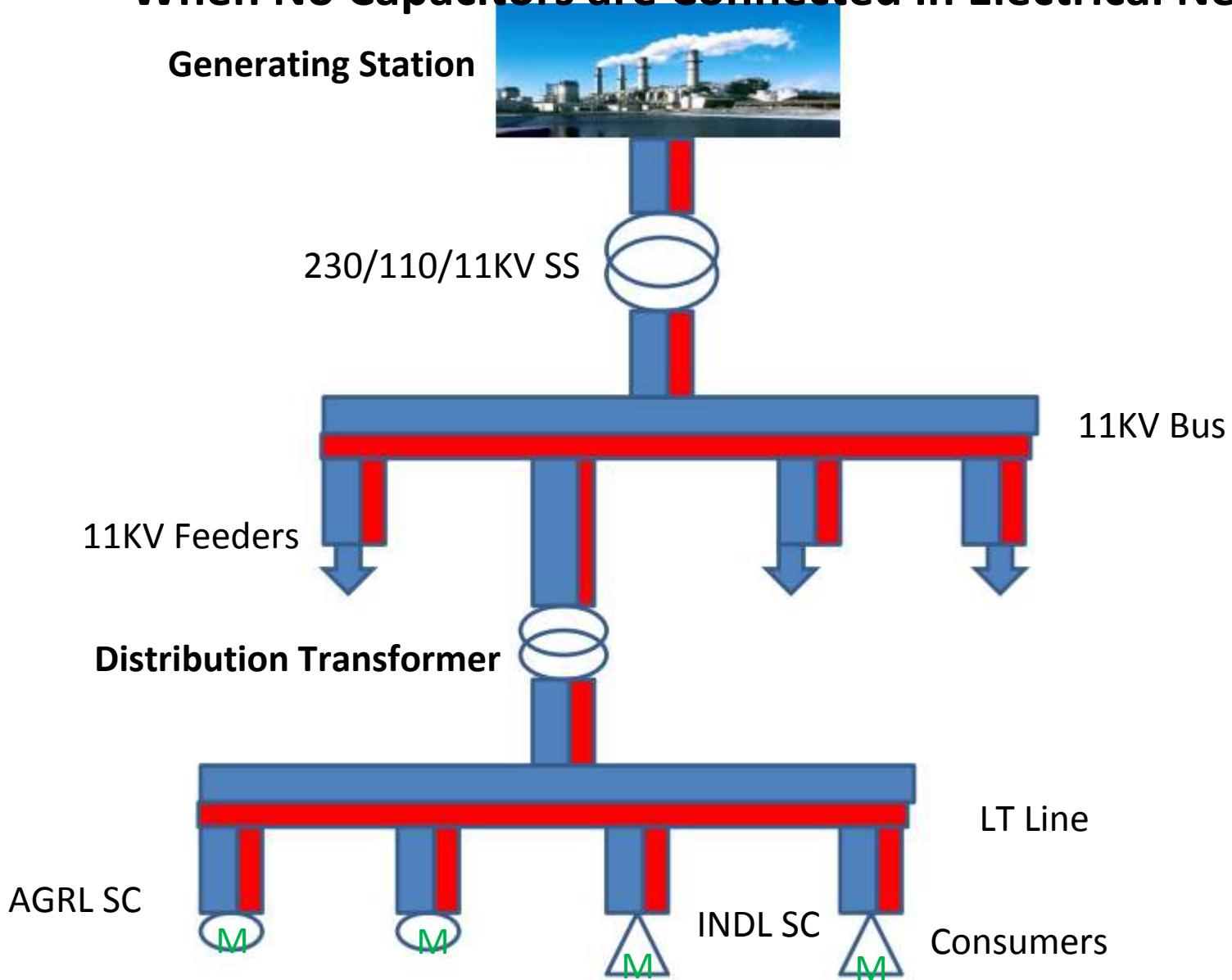

When Capacitors are Connected at Sub-Station

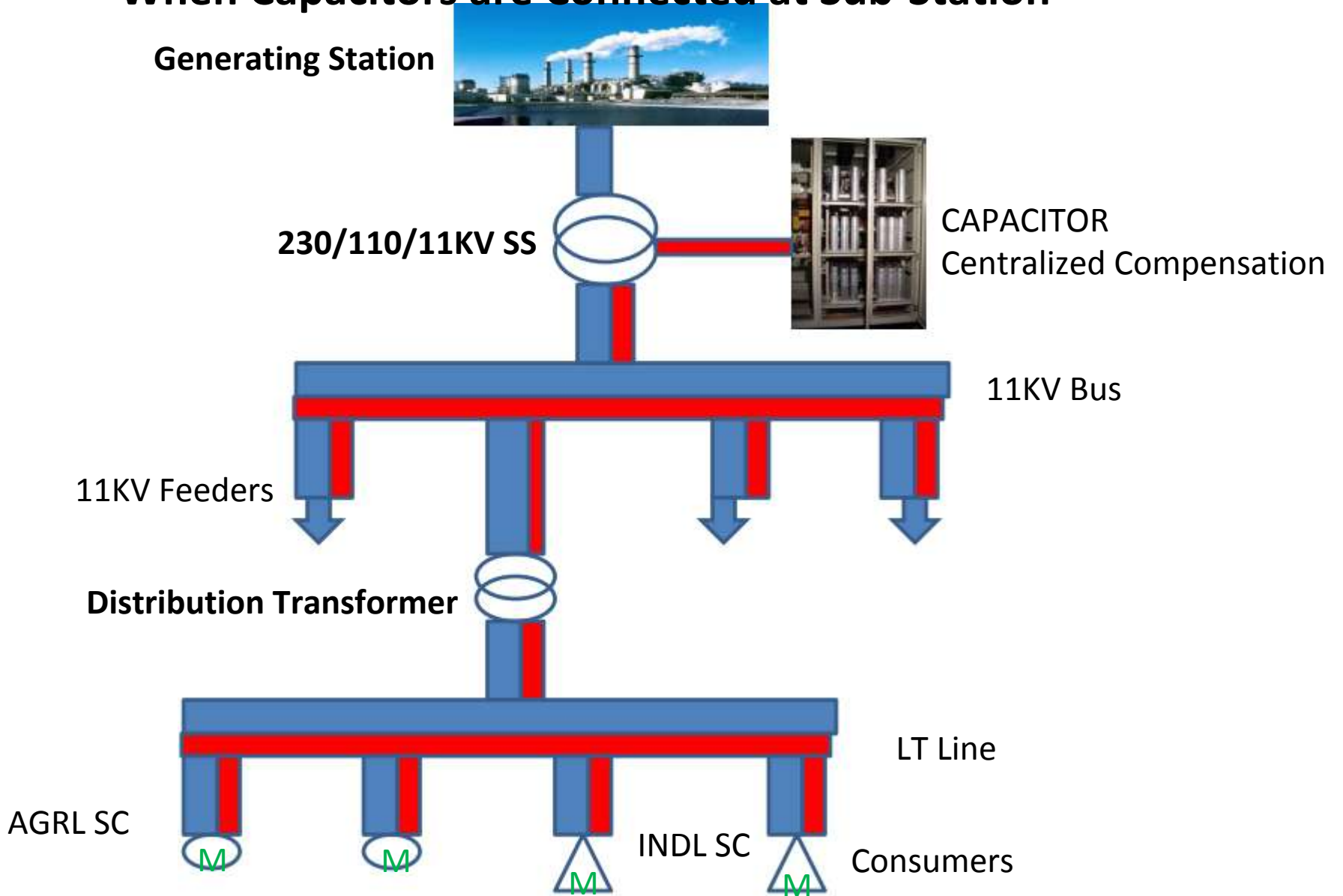

When Capacitors are Connected at Distribution

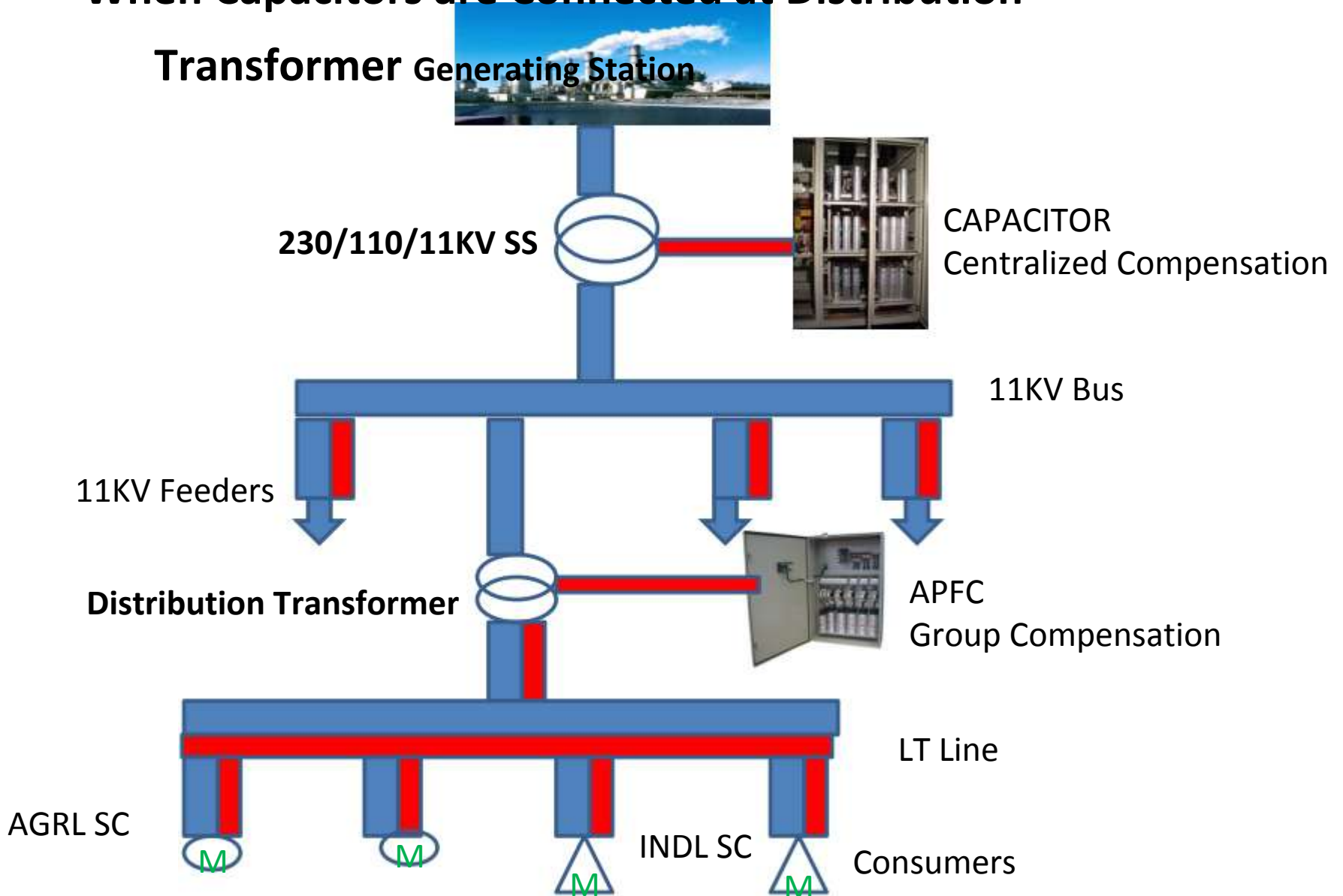

When Capacitors are Connected at Load End

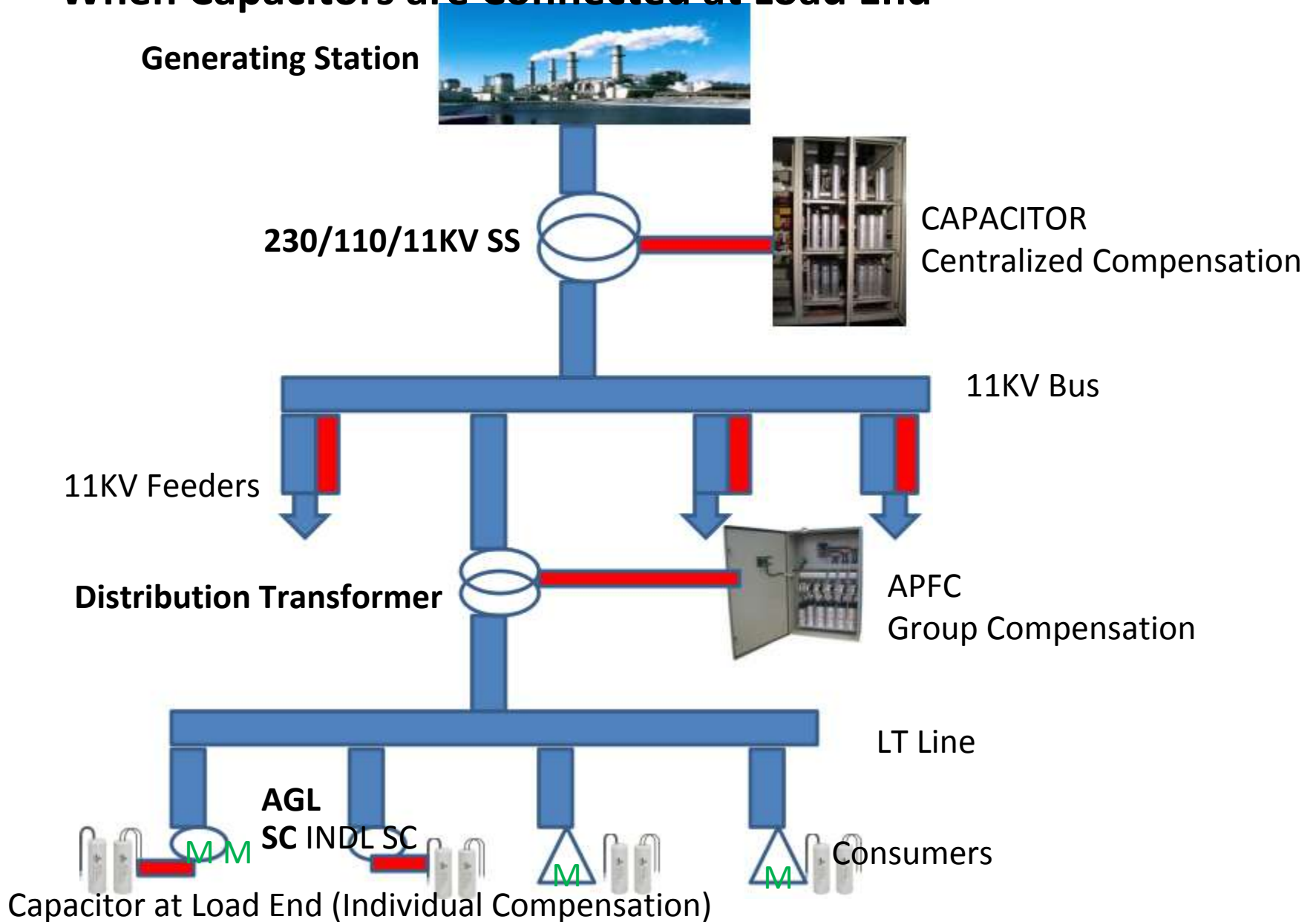

Installing capacitors at the terminals of each agricultural motors

The reactive power draw from the generating stations can be reduced to a maximum by installing capacitors at the agriculture motors numbering to 20.34 lakhs and hence a lot of revenue saving to the TNEB can be easily achieved. The payback period towards the cost of installation of capacitors will be a few months only.

PILOT STUDY:

To emphasize the benefits of the reactive power management and demonstrate practically the effect of capacitor in reduction of loss in agricultural segment, a pilot study was executed in 5 Nos. HT feeders of predominant agriculture load in each Electricity Distribution Circle of Erode Region in TANGEDCO.

Feeders selected for the study:

Name of circle	Name of substation	Name of feeder
Erode	Nadupalayam 110/22-11 KV	Punjai Kalamangalam 22 KV
Gobi	Kugalur 110/22-11 KV	Athani 22 KV
Mettur	Poolampatty 110/22 KV	Poolampatty 22 KV
Namakkal	Velur 110/11 KV	Suriyampalayam 11 KV
Salem	Karuppur 110/22 KV	Sengaradu 22 KV

Procurement of Capacitors:

Procurement of capacitors have been done through e-tendering for the amount of Rs 28.68 Lakhs for the above feeders.

Profile of Sample study in one of the five feeders- Poolampaati 22KV feeder of Mettur Circle:

Provision of capacitors in all agricultural services have been completed in Poolampatty 22 KV feeder of Poolampatty SS in Mettur EDC from 13.07.2018 to 13.08.2018.

Number of services Capacitor provided :

3 HP	5HP	7.5 HP	10 HP	Total
44	517	240	77	878

Ratings of Capacitors Provided

1 KVAR	2 KVAR	3 KVAR	4 KVAR	Total
44	517	240	77	878

Total amount

1 KVAR	2 KVAR	3 KVAR	4 KVAR	Total
44xRs 415.36= Rs 18,276	517xRs 519.20 =Rs 2,68,426	240xRs 654.90 =Rs 1,57,176	77xRs 848.42 =Rs 65,328	Rs 5,09,206

Method of assessment

The required data of 22Kv feeder such as KVA, KVAR, KW , Amp, Voltage, P.F etc., were recorded with high precision electronic meter installed in its feeder panel for both period before and after installation of capacitors. The stored data were downloaded by CMRI Data for comparative analysis. Similarly, electrical parameters in the LT side were measured and documented by using Clamp on meters by taking readings at the spot itself before and after installing the capacitors and analysed.

Date wise installation of Capacitors

Capacitor provided in Pollampatty 22 KV

Date of commissioned	1 KVAR	2KVAR	3 KVAR	4 KVAR	Total
13-Jul-18		13			13
16-Jul-18		9		1	10
17-Jul-18	3	19			22
19-Jul-18	9	24	11		44
20-Jul-18		23	14		37
21-Jul-18		22	5	11	38
23-Jul-18		27	9	6	42
24-Jul-18	7	25	12		44
25-Jul-18		30	16	12	58
26-Jul-18		35	7	1	43
27-Jul-18	3	35	12	12	62
01-Aug-18		34	9		43
02-Aug-18		25	5	7	37
03-Aug-18	2	28	30	5	65
06-Aug-18		27	22		49
07-Aug-18		35	19		54
08-Aug-18	5	27	29		61
09-Aug-18		25	20		45
10-Aug-18	7	14	10	6	37
11-Aug-18	8	12	10	9	39
13-Aug-18		28		7	35
Total	44	517	240	77	878
TOTAL KVAR	44x1=44	517X2=1034	240X3=720	77X4=308	2106



**STUDY
REPORT**

The pre and post data of the study emerge the following results

1. The power factor during the one month of installation gradually improved from 0.85 to 0.96, as the installation progressed day by day.

2. The quantum of reduction in Amp/Kw and allied line loss is around 13% and can be conservatively concluded more than 10%.

3. The reduction in Kvar pumped from the Generation station, flowed through the upstream Grid making loss all the way and finally confluenced in to the Poolampatti feeder AND the reduction in overall Kva are proportionate to the reduction in feeder current.

4. Improvement and stability in voltage profile is evident both in HT and downstream , post the event.

Power factor Improvement before and after capacitor erection at regular intervals:

Readings taken through CMRI		
Date	Average PF	Remarks
01.07.2018	0.855	
05.07.2018	0.862	
10.07.2018	0.855	
12.07.2018	0.856	
20.07.2018	0.860	After erection of capacitor
25.07.2018	0.877	
30.07.2018	0.910	
05.08.2018	0.918	
10.08.2018	0.948	
13.08.2018	0.966	

Power factor Before and After capacitor erection

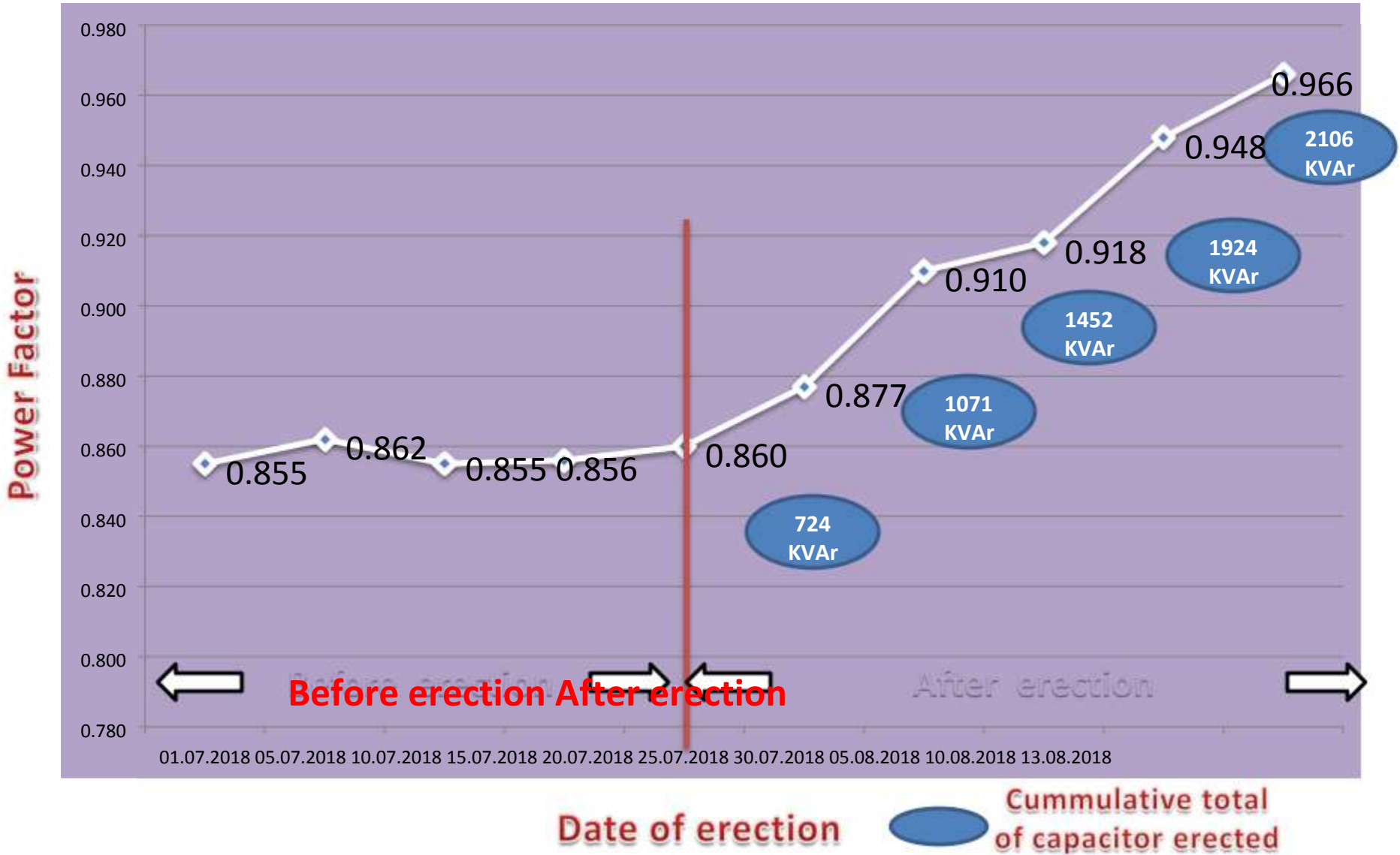

Reduction of Amps/Kw

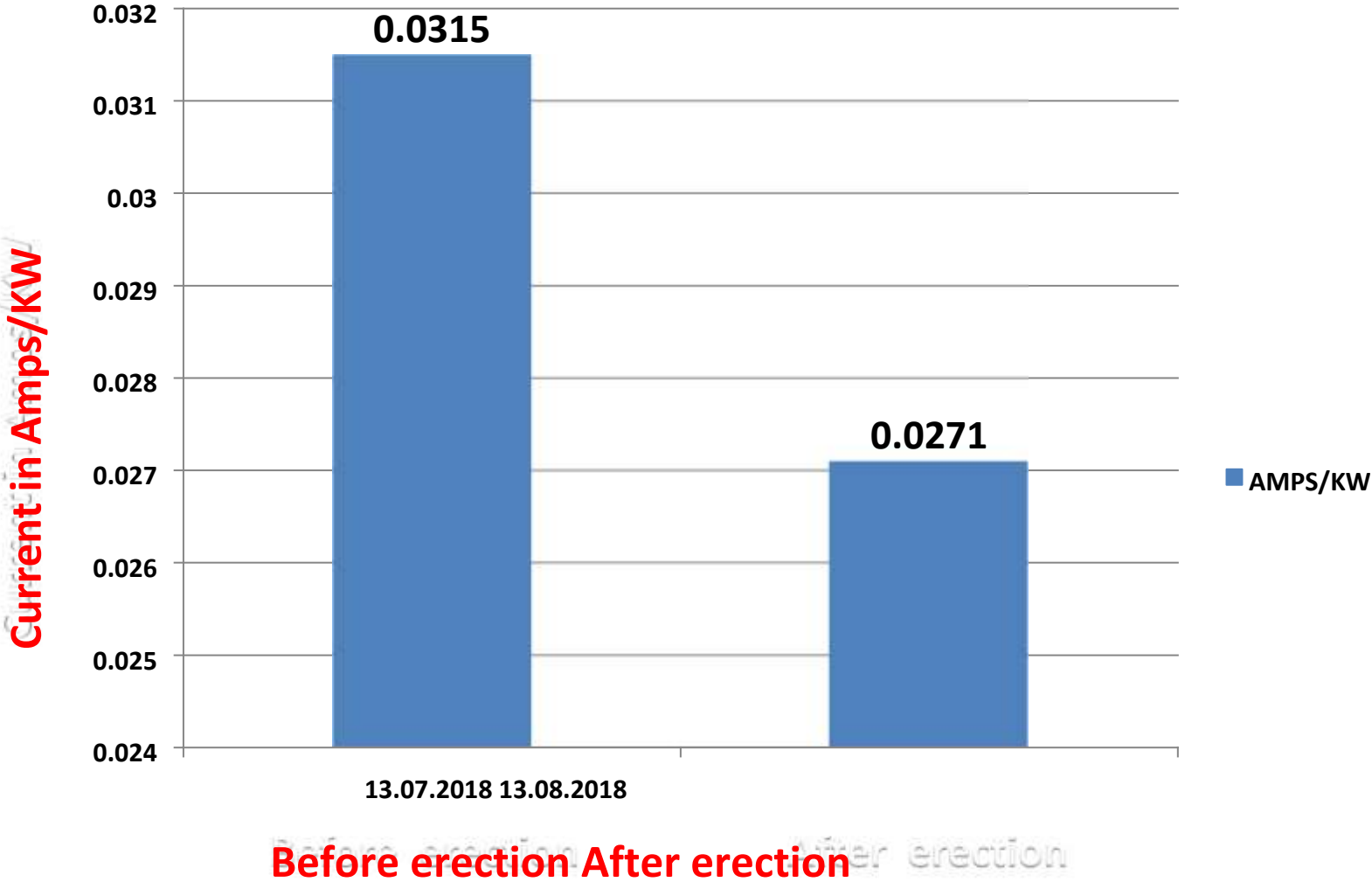

Units savings in HT (Amps/KW)

Date	Amps	Kw	Amps/Kw
13.07.2018 (Before erection of Capacitor)	55.69	1768.13	0.0315
13.08.2018(After erection of Capacitor)	50.44	1859.38	0.0271

$$\begin{aligned} \text{Percentage of reduction of Amps/Kw} &= \frac{0.0315 - 0.0271}{0.0315} \times 100 \\ &= 13.90 \% \end{aligned}$$

Savings with the current

1	Reduction in 11Kv feeder Current at Max Load after installation of capacitor	10 Amps
2	Reduction in 11Kv feeder Current at Min Load after installation of capacitor	5 Amps
3	Average	7.5 Amps
4	Savings in Units for One hour	$7.5A \times 22KV \times 1.732 \times 0.96$
		275 Units

Vector Diagram showing Reduction in KVA and KVAr for same KW

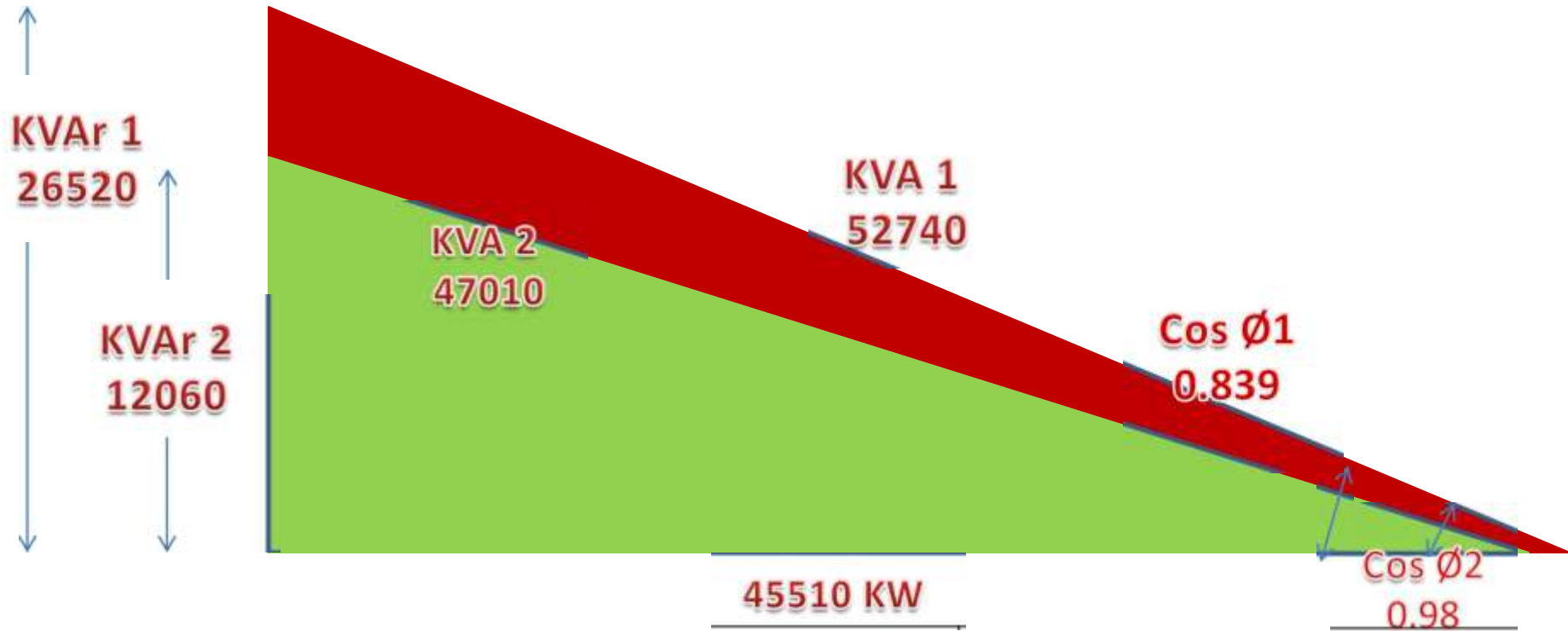

PARAMETERS	DAILY KWH CONSUMPTION	DAILY KVARH CONSUMPTION	DAILY KVAH CONSUMPTION	PF
Before erection (30.6.2018)	45510	26520	52740	0.839
After Erection (14.08.2018)	45390	12060	47010	0.980

Reduction in KVARH and KVAH for the same KWH after capacitor installation

PARAMETERS	DAILY KWH CONSUMPTION	DAILY KVARH CONSUMPTION	DAILY KVAH CONSUMPTION
Before erection (30.6.2018)	45510	26520	52740
After Erection (14.08.2018)	45390	12060	47010

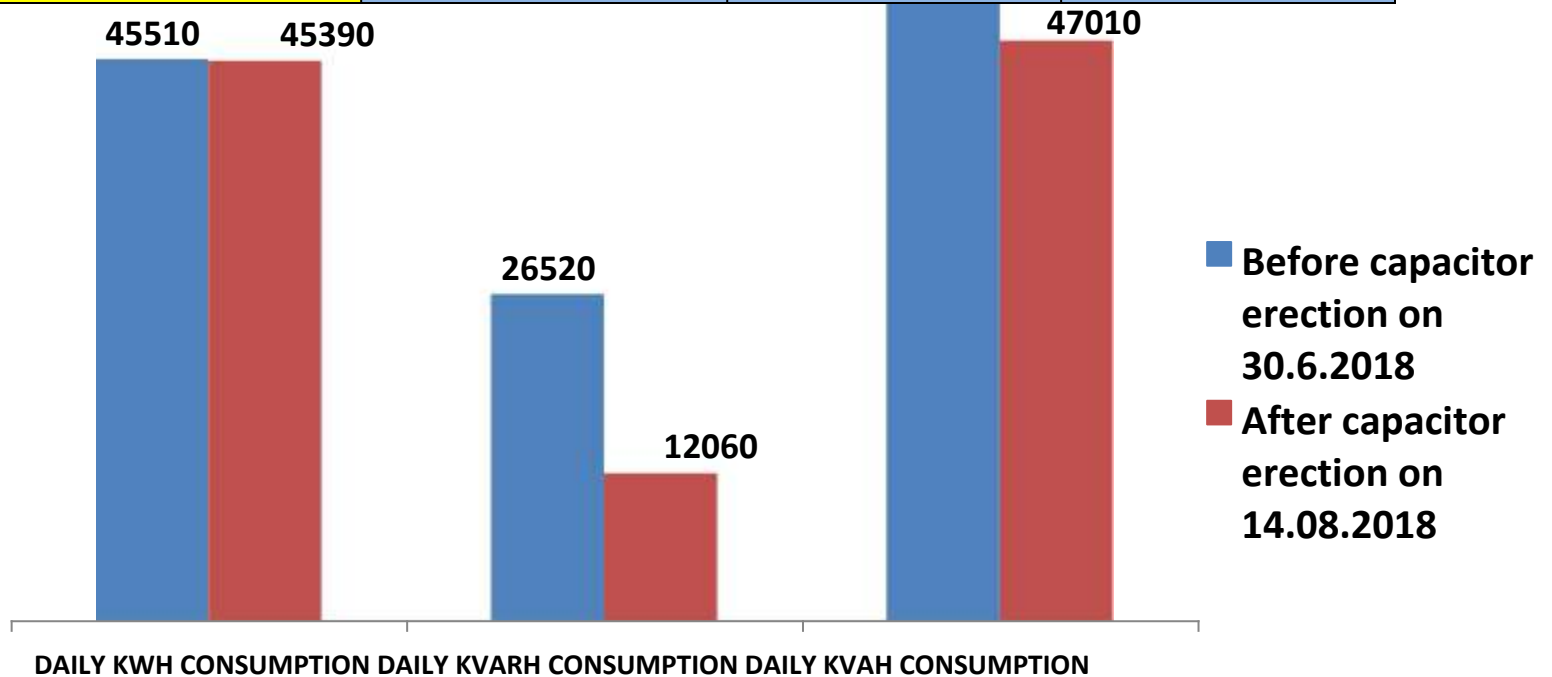

DAILY KVAH CONSUMPTION FOR SAME

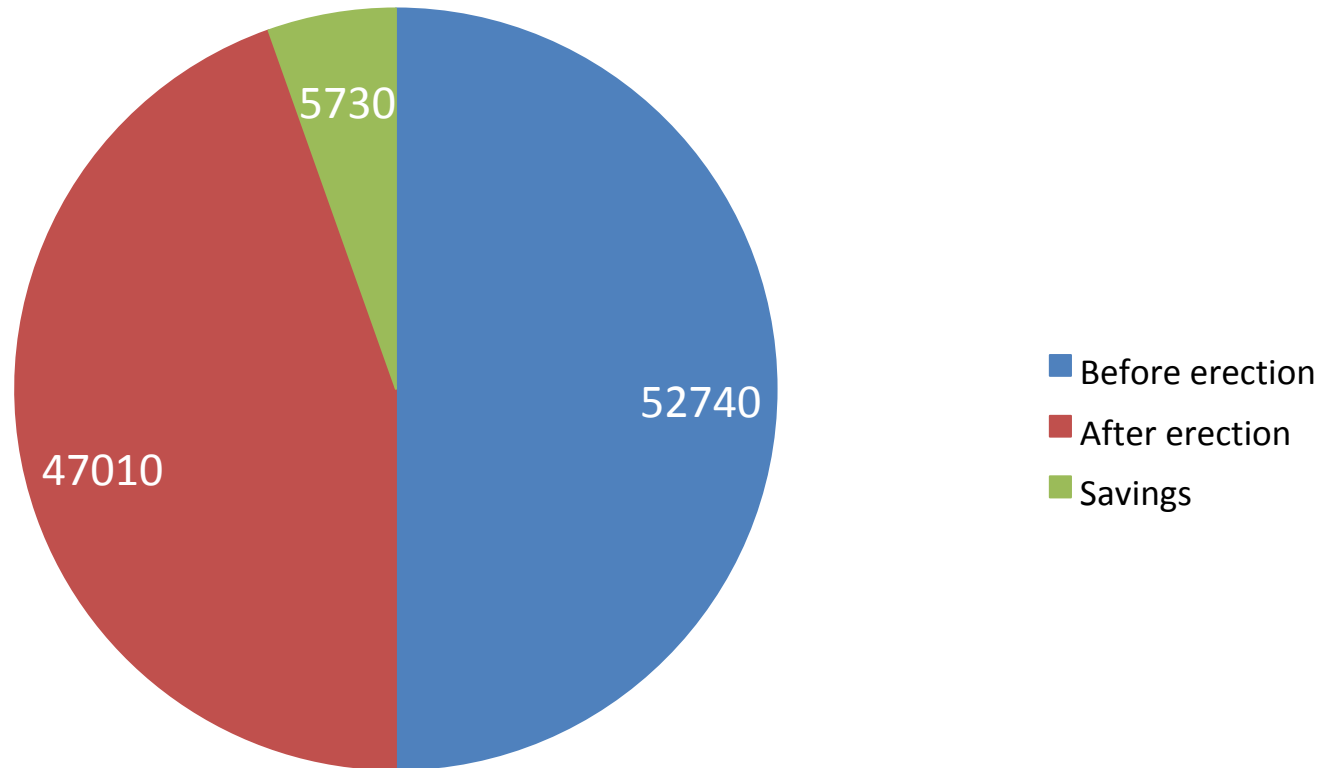

DAILY KVAH CONSUMPTION	
Before erection	52740
After erection	47010
Savings	5730
Savings in %	10.86%

DAILY KVARH CONSUMPTION FOR SAME

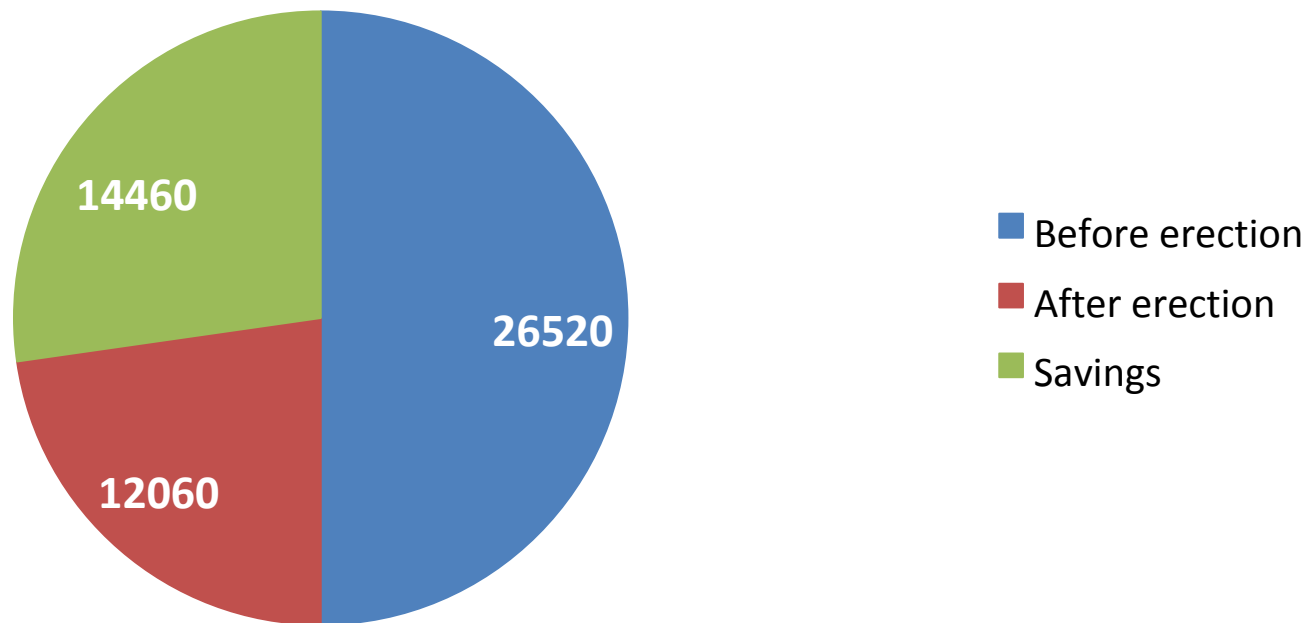

DAILY KVARH CONSUMPTION	
Before erection	26520
After erection	12060
Savings	14460
Savings in %	54.52%

Data showing improved capability of feeder with additional KWh for the same KVAH after installation of

Date	KWH READING	DAILY KWH CONSUMPTION (WITH MF 600)	HOURLY KWH CONSUMPTION	KVARH READING	DAILY KVARH CONSUMPTION (WITH MF 600)	HOURLY KVARH CONSUMPTION	KVAHR READING	DAILY KVAH CONSUMPTION (WITH MF 600)	HOURLY KVAH CONSUMPTION	PF
Before capacitor erection										
27.6.18	1047.85	37260	1552.5	616.55	21780	907.55	1216.25	43200	1800	0.8625
28.6.18	1109.95	64350	2681.25	652.85	37710	1571.25	1288.25	74610	3108.75	0.8624
29.6.18	1217.2	66960	2790	715.7	39810	1658.75	1412.6	77880	3245	0.8597
	3375	168570	7023.75	1985.1	99300	4137.5	3917.1	195690	8153.75	

1.	KWh after erection of capacitor for the same KVAh		189360	
2.	KWh Before erection of capacitor for the same KVAh		168570	
3.	Additional KWh earned for 3 days		20790	
4.	Additional KWh earned per day	20790/3 days	6930	
5.	Savings in terms of value/Month	6930X RS 5.00	34650	
6.	Savings in terms of value/Year		1,26,47,250	= 1.26 Crores per year
7.	Investment made		5,09,206	
8.	Return on investment with in a month			

For the same 1,95,690 KVA the quantum of KWh has increased from 168570 to 189360. i.e

Revenue realization

- **Nearly 11 % of apparent power (KVAhr) is saved from this feeder which could be sold to other new prospective consumers without any investment towards the network improvement . To that extent the Grid demand will also be reduced and consequently the gap between supply and demand is narrowed . The revenue realized through sale of additional power from the saved units with existing network will be many times to that of the investment made to the capacitors.**
- **In addition to the above, the revenue saved through line loss savings, if taken into account, the capital investment made towards reactive power management is meager.**
- **The investment made for this feeder is Rs. 5,09,206/- by installation of capacitors. There is no recurring running and maintenance cost. The capital investment will be recovered within a few months and thereafter there will be accrual of savings only.**

Capacitor voltage rating

The rated voltage at the motor terminal is 400V as per IS12360. However during light loads, and due to voltage fluctuations on the electric system on various causes and occasions, the voltage may be beyond the permissible limit.

As a precautionary measure it is safer to install capacitors of **voltage rating 525 volt** to agricultural motors in rural feeders. This will avoid premature failure of capacitors on account of over voltage and longer life of capacitors is also ensured.

Strategies to be adopted for effective Implementation

- 1. Three phase Agriculture predominant feeders should be selected.**
- 2. Feeders feeding to town Panchayat should be selected so as to book the expenditure under IPD Scheme .**
- 3. To be erected only in working AGL SC .**
- 4. Provision of capacitor to both motors if the SC with DPDT switch.**
- 5. Consumers should be educated regarding benefits of the erection of capacitors.**
- 6. Consumers are also to be sensitised not to disconnect the capacitors at any circumstances.**
- 7. The periodic inspection is to be carried out in the AGL SCs where the capacitors provided to ensure the mechanism in place.**

Contd..

- 8. The feeders' reading should be taken through CMRI before and after capacitors erection for analysis.**
- 9. Capacitors should be connected after main switch. If the motor is star delta connection, capacitor should be connected in Delta connection side.**
- 10. Capacitor to be purchased under e tendering .Labour rate should be approved at regional level. i.e Rs 150/- per service including tax.**
- 11. Clamp on meter to be purchased and issued to field for taking readings.**

Readings to be recorded before and after installation of

- **Hourly reading of feeder meter for the parameters voltage, current, Frequency, PF, KWHr, KVAHr, KVArh to be taken for the selected feeders and to be recorded in a separate register .**
- **DLMS compliant feeder meter to be provided in the selected feeder.**
- **No. of Distribution Transformer connected in the feeder along with DT metering arrangement.**
- **HP wise agriculture service connection in the selected feeders to be recorded.**

Pilot study readings and other documents

Before capacitor Installation (HT feeder 's

Date	KWH READING	DAILY KWH CONSUMPTION (WITH MF 600)	HOURLY KWH CONSUMPTION	KVARH READING	DAILY KVARH CONSUMPTION (WITH MF 600)	HOURLY KVARH CONSUMPTION	KVAHR READING	DAILY KVAH CONSUMPTION (WITH MF 600)	HOURLY KVAH CONSUMPTION	PF
18-06-2018	122	48810	2033.75	74.95	29310	1221.25	143.3	56940	2372.5	0.857218
19-06-2018	203.35	53220	2217.5	123.8	31290	1303.75	238.2	61770	2573.75	0.861583
20-06-2018	292.05	62700	2612.5	175.95	37260	1552.5	341.15	72960	3040	0.859375
21-06-2018	396.55	66060	2752.5	238.05	38070	1586.25	462.75	76260	3177.5	0.866247
22-06-2018	506.65	67710	2821.25	301.5	39360	1640	589.85	78360	3265	0.864089
23-06-2018	619.5	64530	2688.75	367.1	37350	1556.25	720.45	74580	3107.5	0.865245
24-06-2018	727.05	66090	2753.75	429.35	38400	1600	844.75	76440	3185	0.8646
25-06-2018	837.2	60210	2508.75	493.35	35190	1466.25	972.15	69780	2907.5	0.862855
26-06-2018	937.55	66180	2757.5	552	38730	1613.75	1088.45	76680	3195	0.863067
27-06-2018	1047.85	37260	1552.5	616.55	21780	907.5	1216.25	43200	1800	0.8625
28-06-2018	1109.95	64350	2681.25	652.85	37710	1571.25	1288.25	74610	3108.75	0.862485
29-06-2018	1217.2	66960	2790	715.7	39810	1658.75	1412.6	77880	3245	0.859784
30-06-2018	1328.8	45510	1896.25	782.05	26520	1105	1542.4	52740	2197.5	0.862912
01-07-2018	1404.65	52140	2172.5	826.25	31440	1310	1630.3	60900	2537.5	0.856158
02-07-2018	1491.55	32400	1350	878.65	19590	816.25	1731.8	37860	1577.5	0.855784

Set of Readings of same feeder to analyse Amp/KW .

DATE	VOLTAGE	AVG PF	KVA	KVAr	AMPS	KW	AMP/KW
01.07.2018	21.51	0.855	2537.63	1309.88	68.29	2172.75	0.0314
02.07.2018	21.86	0.847	1577.63	815.25	42.11	1349.75	0.0312
03.07.2018	21.82	0.847	1555.13	820.88	41.18	1319.63	0.0312
04.07.2018	21.50	0.858	2271.25	1161.50	62.11	1950.88	0.0318
05.07.2018	21.21	0.862	2755.25	1389.88	75.23	2379.00	0.0316
06.07.2018	20.63	0.866	3062.50	1527.88	84.06	2653.50	0.0317
07.07.2018	21.61	0.854	3266.88	1692.63	87.49	2793.63	0.0313
08.07.2018	21.89	0.844	3255.50	1739.63	86.01	2750.75	0.0313
09.07.2018	21.78	0.838	2725.75	1476.25	72.65	2289.88	0.0317
10.07.2018	21.83	0.835	2295.38	1257.13	60.92	1919.00	0.0317
11.07.2018	21.77	0.836	1616.50	884.25	42.94	1352.63	0.0317
12.07.2018	21.79	0.836	1661.75	902.00	44.14	1393.88	0.0317
13.07.2018	21.47	0.856	2063.75	1063.88	55.69	1768.13	0.0315
14.07.2018	21.47	0.857	2357.63	1208.25	63.62	2024.50	0.0314
15.07.2018	21.70	0.855	2834.38	1468.75	75.53	2424.25	0.0312
16.07.2018	21.53	0.854	2960.75	1534.00	81.04	2531.63	0.0320
17.07.2018	21.50	0.857	2960.75	1534.00	88.37	2531.63	0.0349
18.07.2018	21.51	0.904	3153.93	1619.62	87.82	2705.43	0.0325
19.07.2018	21.23	0.859	3510.88	1788.25	95.94	3019.75	0.0318
20.07.2018	21.30	0.857	3445.50	1768.50	93.74	2955.63	0.0317

Contd..

Set of Readings of same feeder to analyse Amp/KW .

DATE	VOLTAGE	AVG PF	KVA	KVAr	AMPS	KW	AMP/KW
21.07.2018	21.62	0.851	3591.88	1879.38	96.11	3059.00	0.0314
22.07.2018	21.55	0.856	3455.63	1781.88	92.73	2960.25	0.0313
23.07.2018	21.31	0.860	3366.13	1709.75	91.44	2898.88	0.0315
24.07.2018	21.07	0.871	3155.00	1543.00	86.75	2750.88	0.0315
25.07.2018	21.21	0.877	3031.13	1450.88	82.79	2660.75	0.0311
26.07.2018	21.46	0.889	2339.75	1072.88	62.98	2077.13	0.0303
27.07.2018	21.32	0.899	2226.75	972.88	60.54	2002.38	0.0302
28.07.2018	21.34	0.901	2570.00	1102.88	69.86	2320.88	0.0301
29.07.2018	21.66	0.901	605.38	1395.69	74.59	2515.13	0.0297
30.07.2018	21.41	0.910	2651.63	1098.25	71.78	2412.13	0.0298
31.07.2018	21.73	0.910	2240.88	1022.88	65.69	2464.00	0.0267
01.08.2018	21.92	0.908	2931.00	1230.13	77.56	2659.50	0.0292
02.08.2018	21.81	0.915	2933.13	1182.63	77.56	2683.25	0.0289
03.08.2018	22.16	0.913	2872.88	1171.88	74.81	2622.38	0.0285
04.08.2018	22.07	0.916	2669.50	1069.25	71.31	2445.63	0.0292
05.08.2018	22.11	0.918	2373.50	944.38	62.06	2178.13	0.0285
06.08.2018	21.69	0.923	2589.75	989.50	69.00	2392.88	0.0288
07.08.2018	21.62	0.930	2463.50	900.88	65.88	2292.13	0.0287
08.08.2018	22.04	0.929	2549.00	954.75	67.38	2362.63	0.0285
09.08.2018	21.76	0.933	2515.88	910.25	66.75	2345.75	0.0285
10.08.2018	21.55	0.948	2459.38	787.88	66.50	2328.63	0.0286
11.08.2018	21.93	0.964	1979.63	538.75	52.00	2328.63	0.0223
12.08.2018	22.09	0.967	1938.38	486.38	50.69	2328.63	0.0218
13.08.2018	22.06	0.966	1924.38	493.75	50.44	1859.38	0.0271

Study at LT side in Sample Services

SL NO	DATE	SC NO	CAPACITOR RATING IN KVAR	AMPS/KW (Before errection)	AMPS/KW (After errection)	Reduction in AMPS
1	19.07.2018	83	2	5.53	5.13	7.84%
2	19.07.2018	61	2	5.00	4.41	10.68%
3	19.07.2018	4	3	5.49	5.00	8.51%
4	19.07.2018	296	3	7.41	5.22	27.69%
5	20.07.2018	455	3	5.57	4.79	12.61%
6	20.07.2018	567	2	5.56	4.84	11.92%
7	20.07.2018	470	3	5.34	4.48	17.92%

Study at LT side in sample

SL NO	DATE	SC NO	CAPACITOR RATING IN KVAR	AMPS/KW (Before errection)	AMPS/KW (After errection)	Reduction in AMPS
10	23.07.2018	576	4	5.13	4.11	15.00%
11	24.07.2018	295	2	5.69	4.73	16.42%
12	24.07.2018	359	2	5.13	4.79	19.20%
13	24.07.2018	329	2	6.01	4.93	19.44%
14	25.07.2018	172	4	5.48	4.52	13.10%
15	25.07.2018	254	3	5.85	5.05	14.04%
16	30.07.2018	548	3	5.76	4.88	14.92%

Estimate for total implementation for all Agri Pumpsets in TN

Sl.No	Agri Pumpsets HP	Nos. As on 31.03.2013	CL as on 31.03.2013	Nos. As on 31.03.2017	KVAR / Pump	Total KVAR REQUIRED	Price for KVAR as per P.O	Total Price	Labour cost	TOTAL
1	3	5,82,189	16,43,673	5,99,367	1	599367	415.36	24,89,53,210	89905098	33,88,58,308
2	5	9,80,959	49,99,685	10,09,904	2	2019807	519.2	1,04,86,83,897	151485540	1,20,01,69,437
3	7.5	3,00,760	22,83,390	3,09,634	3	928903	654.9	60,83,38,616	46445153	65,47,83,769
4	10	1,06,361	10,15,630	1,09,499	4	437997	848.42	37,16,05,698	16424900	38,80,30,598
5	12.5	29,911	3,33,987	30,794	5	153968	848.4	13,06,26,311	4619035	13,52,45,346
6	15	23,990	3,52,785	24,698	6	148187	1365.26	20,23,13,996	3704679	20,60,18,675
7	17.5	1,042	31,412	1,073	7	7509	1681.5	1,26,26,753	160912	1,27,87,665
8	20	6,148	1,62,040	6,329	8	50635		8,51,43,163	949411	8,60,92,574

Capacitor erected in AGL SC



Capacitor

Reading parameters recorded by using clamp on meter.









Clamp-on meter

Thank you
Small things matter



**PERSPECTIVE OF MSEDCL
(MAHARASHTRA)
ON
REAL TIME MARKET**



- CERC has introduced a Real Time Market (RTM) platform from 01st June-2020 in the Country.
- MSEDCL welcomes the good initiative taken by MoP & CERC for implementation of Real Time Market in the Country .
- RTM is a Half Hourly market
 - ❖ Conducted every half an hour (48 times per day)
 - ❖ Delivery for 30 minutes in two time blocks of 15 minutes each
- RTM is helpful for the management of real-time Load Generation Balance.

- **Management of Real time deviations:**
 - Shortfall due to forced outages/unexpected rise in demand.
 - Surplus due to sudden drop in demand.
 - Unexpected variation in RE generation
- **Cost optimization :**
 - Backing down of costly thermal generation & utilizing cheap power in RTM
- **Hydro Resource optimization:**
 - Koyna Hydro generation is utilized to meet peak demand and in real time deviation, due to limited allocation of water quota, cheap RTM power helps to save the water .
- **Meeting out the shortfall in DAM purchase :**
 - Meeting out Balance Power requirement when complete Power in DAM is not cleared.
- **DSM sign change:**
 - RTM helps for DSM sign change to some extent.

Case-I – Management of UI with RTM after force outage of 660 MW APML unit & unavailable of Koyna Hydro 4 M/cs(1000 MW) – Dt 14th July 2020

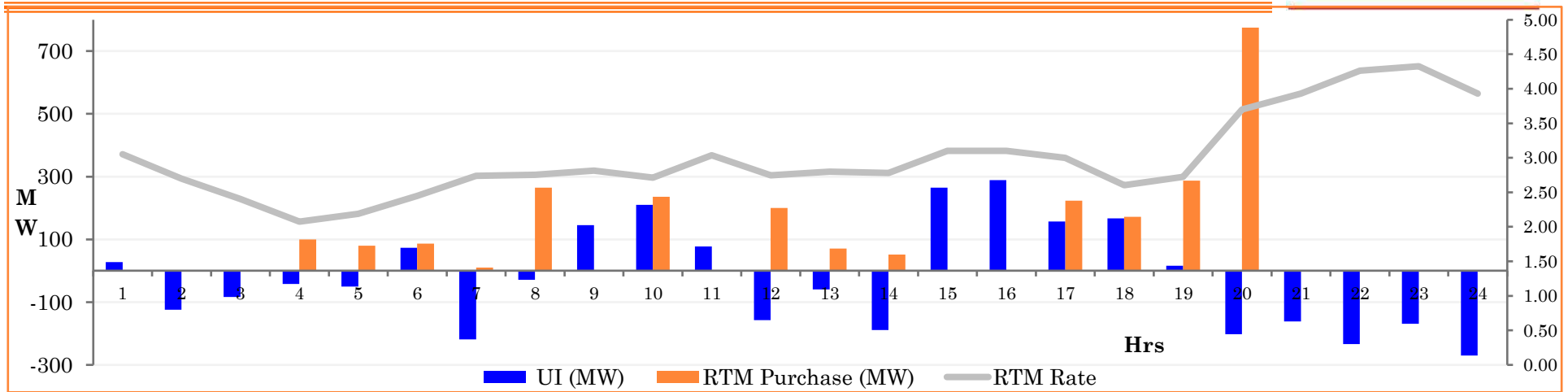

Case-II – Cost Optimization with RTM – by back-down of on-bar thermal generation (19th July 20

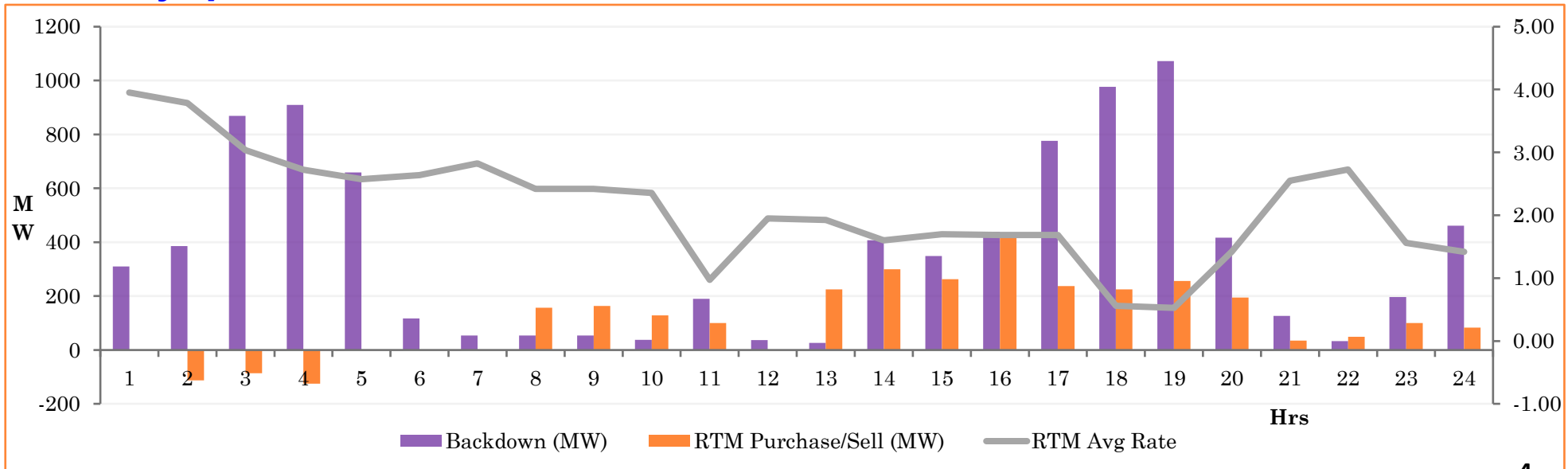

Case-III – Variation in wind generation is managed with RTM (12th June)

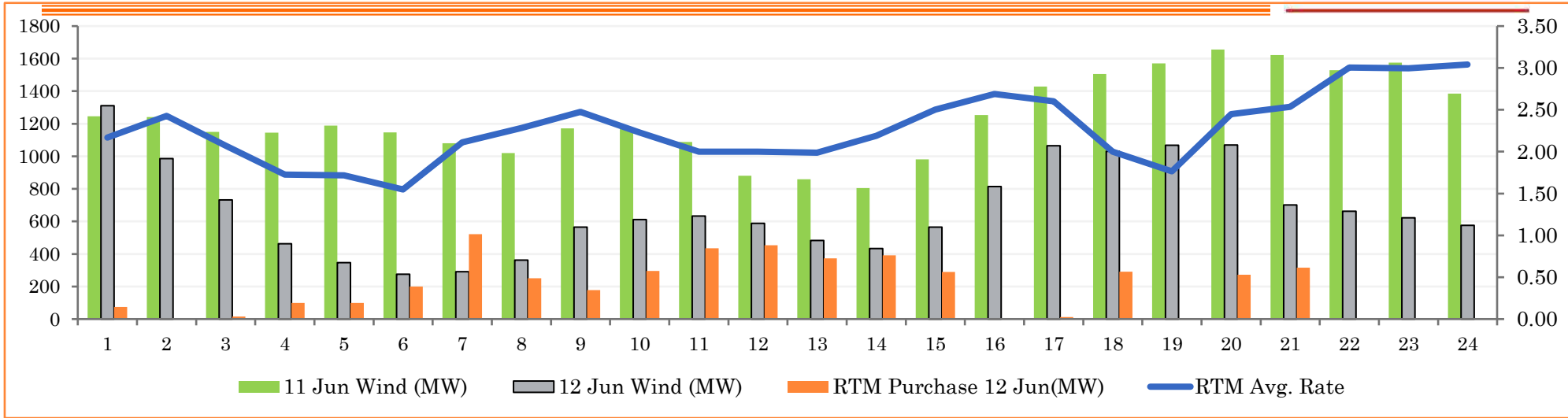

Case-IV – Rise in Demand is managed partly with RTM (9th June)

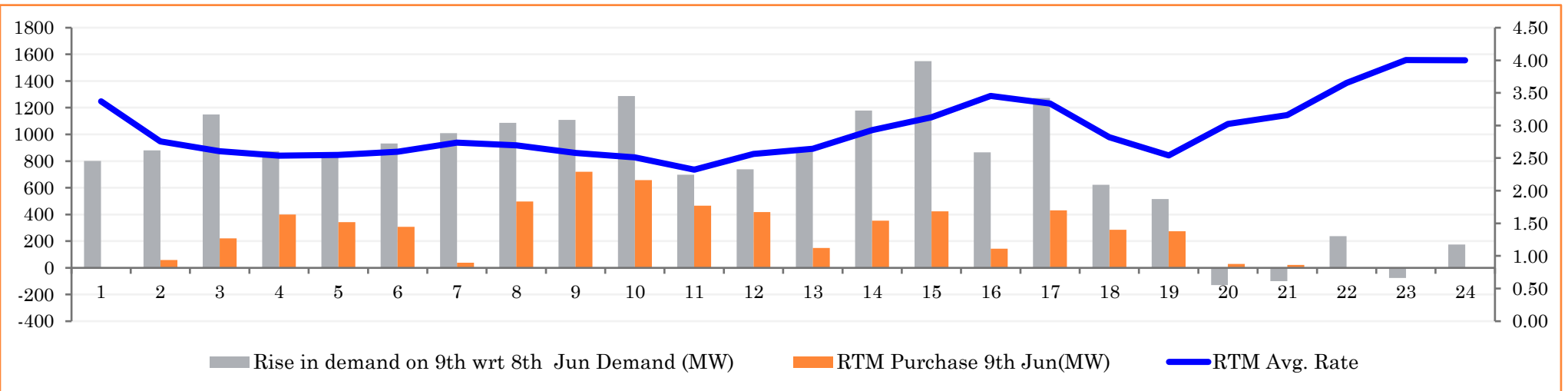

MSEDCL – Power Purchase in DAM & RTM & RTM Benefits

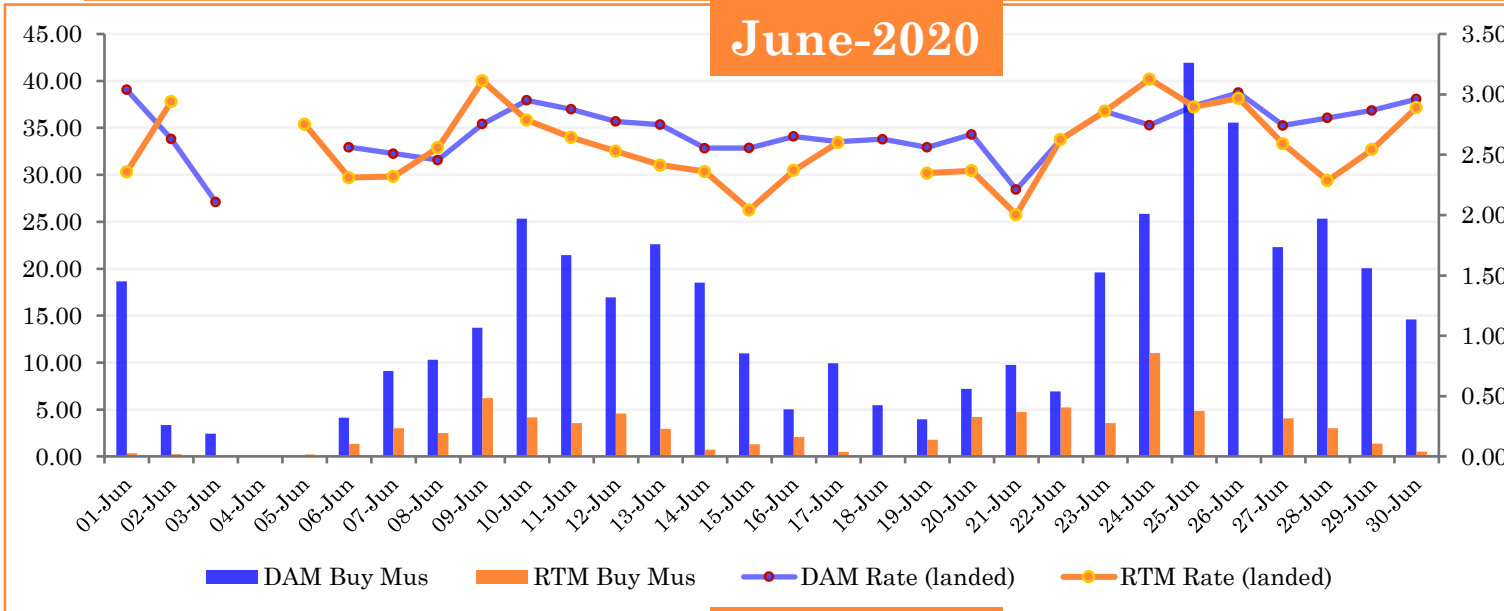

June-2020	
DAM Buy MUS	431.16
DAM Rate (Landed) (Rs/kWh)	2.78
RTM Buy Mus	78.33
RTM Rate (Landed)(Rs/kWh)	2.65
RTM Benefits (in CRs)	5.26

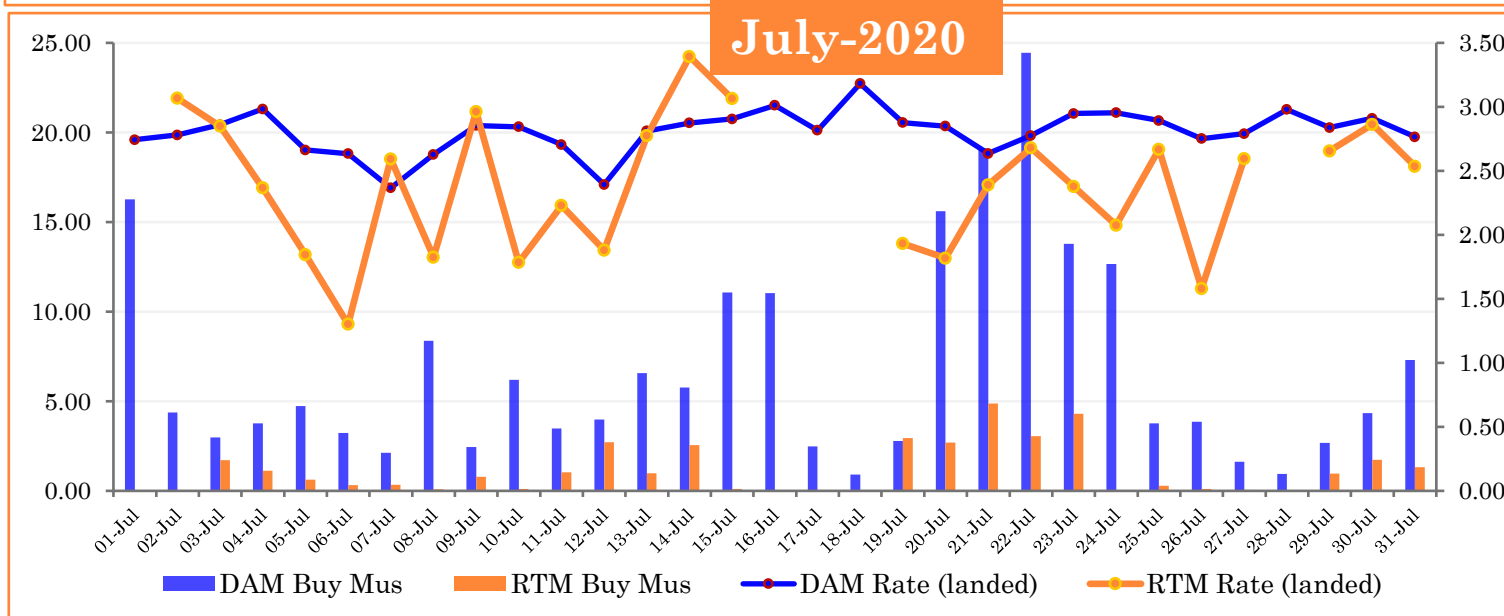

July-2020	
DAM Buy MUS	212.64
DAM Rate (Landed) (Rs/kWh)	2.80
RTM Buy Mus	34.79
RTM Rate (Landed)(Rs/kWh)	2.42
RTM Benefits (in CRs)	4.25

MSEDCL – Power Sell in DAM & RTM & RTM Benefits

July-2020

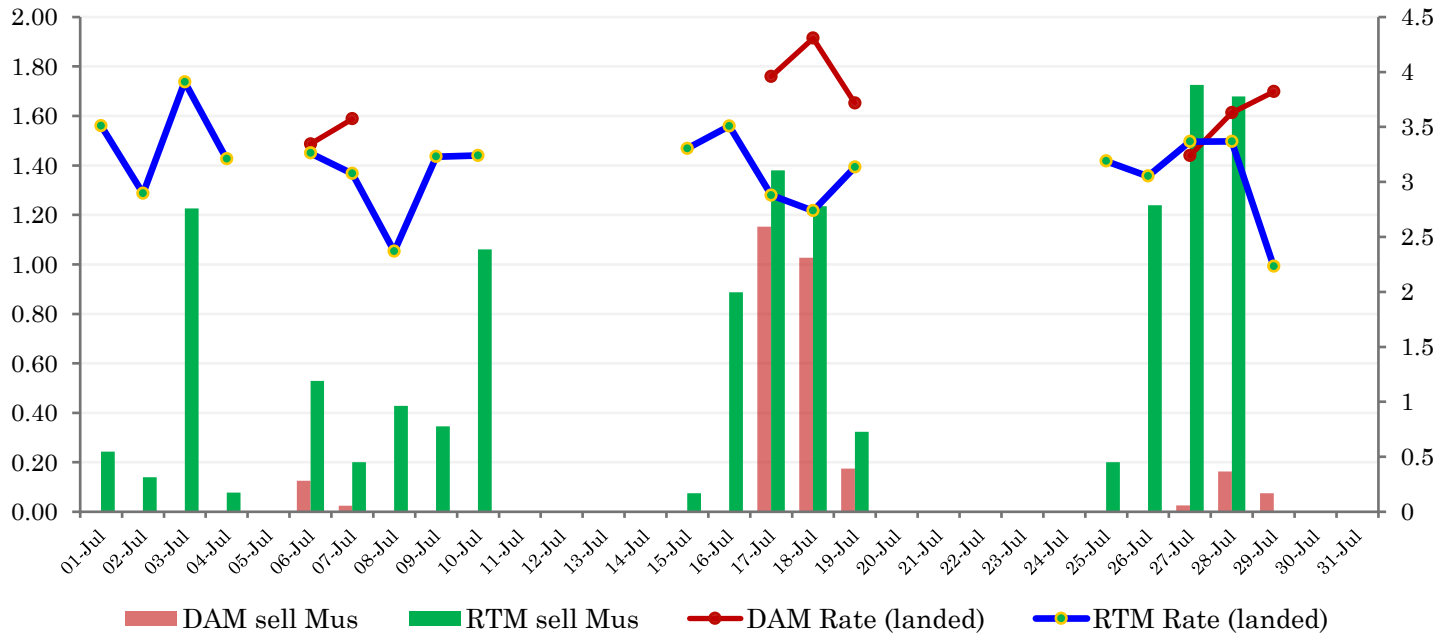

July-2020	
DAM Sell MUS	2.77
DAM Rate (Landed) (Rs/kWh)	4.01
RTM Sell Mus	13.00
RTM Rate (Landed) (Rs/kWh)	3.22
RTM Benefits (in CRs)	1.30

Suggestion for Betterment – Reduction in Gate Closure time & Implementation of NOAR

- Presently, 4 time blocks are kept after Gate Closure time for RTM clearance for checking of Corridor availability & for scheduling process.
- **Issue**
Reduction in flexibility available with DISCOM to manage deviation arising mainly on account of variation in RE
- **Observation**
 - From the last two months experience , it is seen that provisional result of Market are available within 2-3 minute after closing of sessions.
 - It is possible to reduce these 4 blocks to 2 blocks with the following process:
 - NLDC to furnish the available transmission corridors to the Power Exchange(s) before the trading for RTM before specific Gate Closure time.
 - Result of Market to be provided to NLDC & all RLDC/SLDC immediately for scheduling & based on corridor given by NLDC,
 - Schedule to be prepared in immediate 2nd time block from bid submission time block (instead of 4th time block) & SMS/Email alert to all Participant in RTM by Market operator.
 - Fast Track implementation of National Open Access Registry (NOAR)
- Possibility shall be explored to make market for 15 min instead of 30 min.

- For Reduction in power purchase cost and utilization of RTM Power,
 - Accurate Demand Forecasting, Power Schedule Optimizer is required.
 - Good communication network for monitoring generation & load point data in real time is required.
- **Development of National level Demand Forecasting & Schedule Optimizer software and to be made available to all DISCOMs/system operators.**
- **Strengthening of Communication network for real time data transfer**

THANK YOU